

) david
trubridge

Toru
1100mm/43"

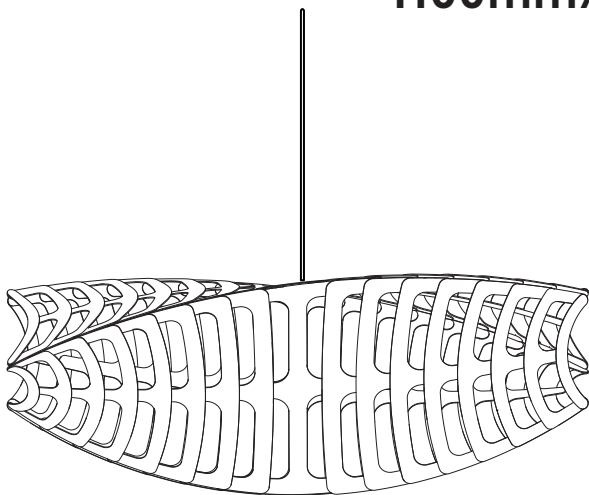
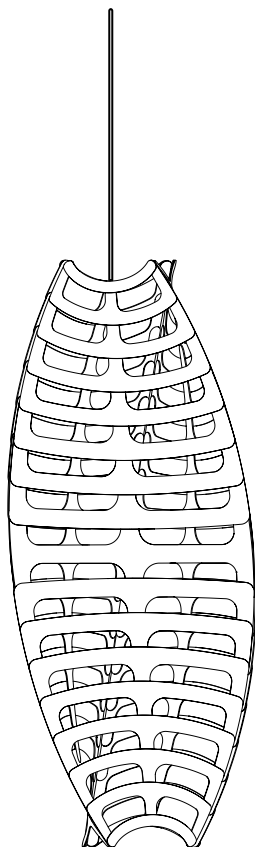

Assembly Video:

Video montaggio\ Montage video\
Vidéo d'assemblage\ Montage video

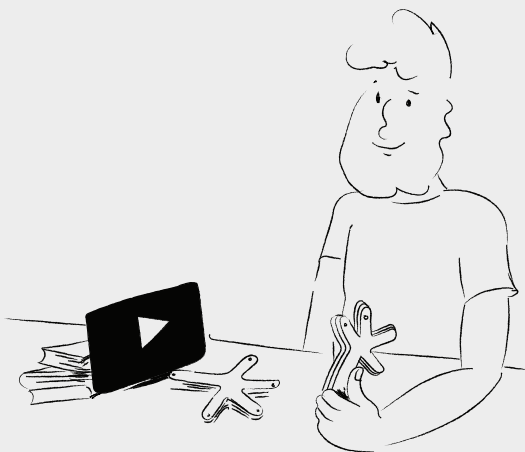

Please check your components:

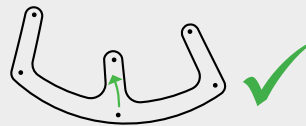
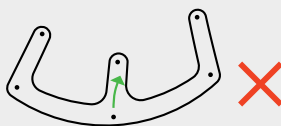
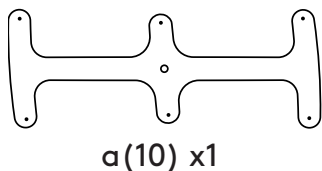
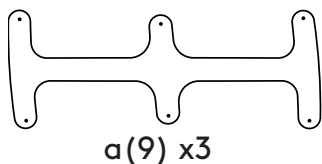
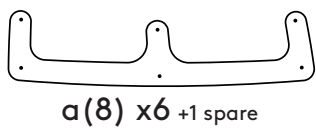
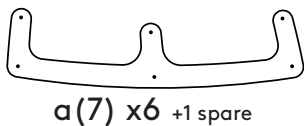
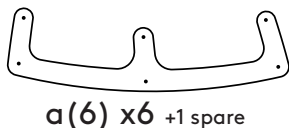
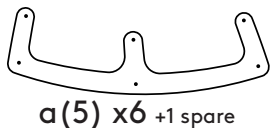
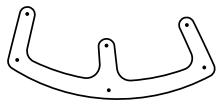
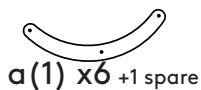

EN - Please make sure to lay out the kit set pieces so the centre line is leaning toward the left

IT - Assicurarsi di disporre i pezzi del kit in modo che la linea centrale sia inclinata verso sinistra

DE - Achten Sie bitte darauf, dass Sie die Teile so auslegen, dass die Mittellinie nach links geneigt ist

FR - Faites attention à disposer les pièces de façon à ce que la partie du milieu penche vers la gauche

DK - Sørg for at lægge sætdele ud, så centerlinjen hælder mod venstre

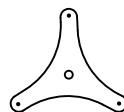
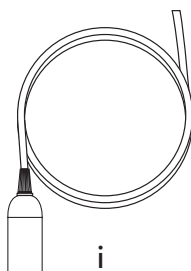
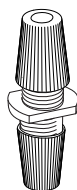
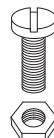
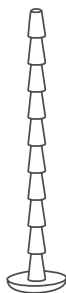

EN - Optional lamp holder cover

IT - Coperchio del portalamпада opzionale

DE - Abdeckung für Lampenfassung optional

FR - Piéce en silicone (optionnelle)

DK - Vælgfri dæksel for pæreholderen

Horizontal Instructions

Orizzontale istruzioni\ Horizontal instruktioner\
Horizontal instructions\ Vandret anweisungen

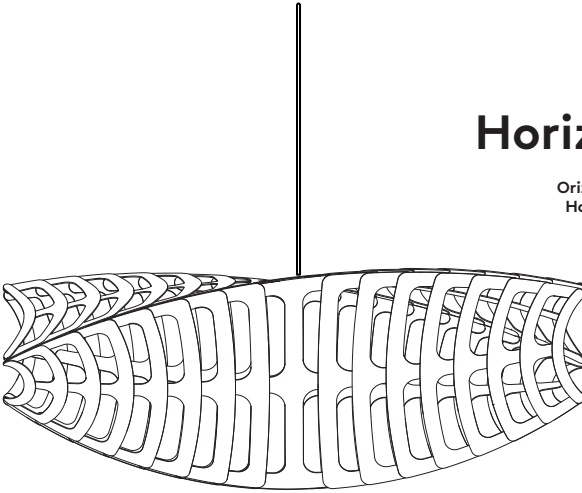

Page 1 - 8

Vertical Instructions

Verticale istruzioni\ Vertikal instruktioner\
Vertical instructions\ Lodret anweisungen

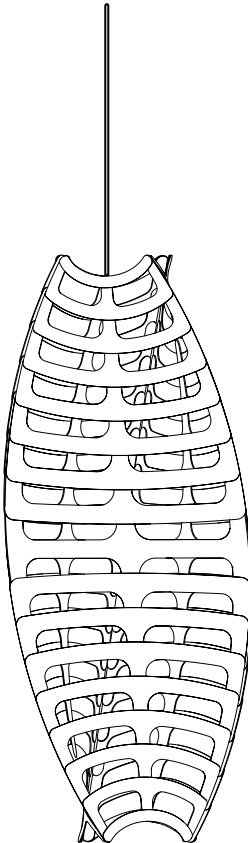

Page 9 - 16

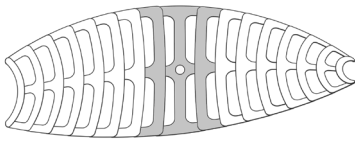

1

Horizontal

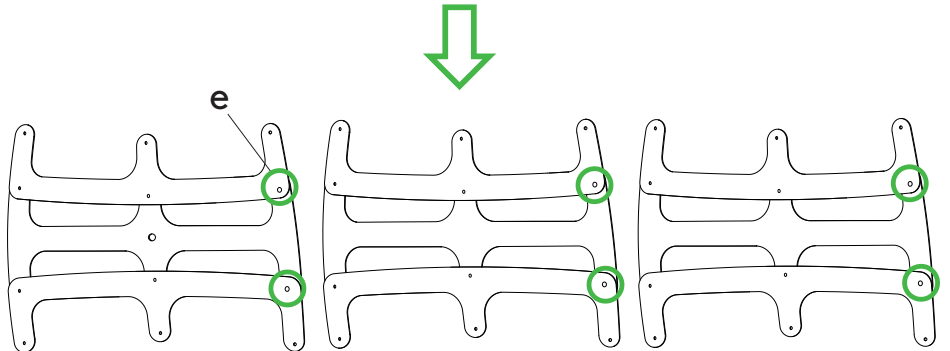
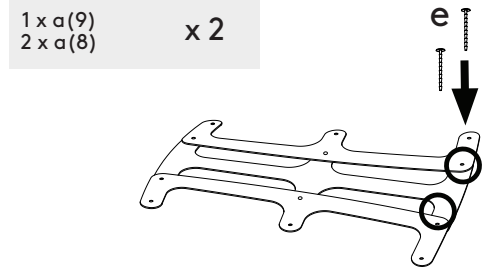
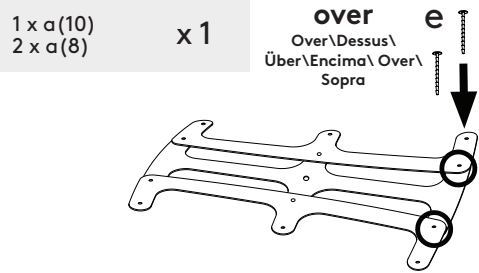
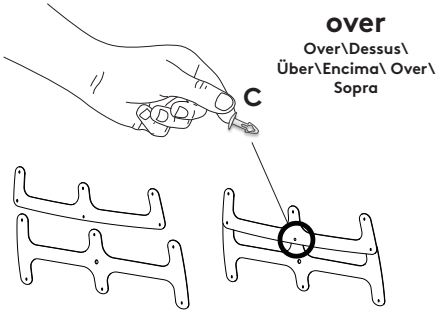
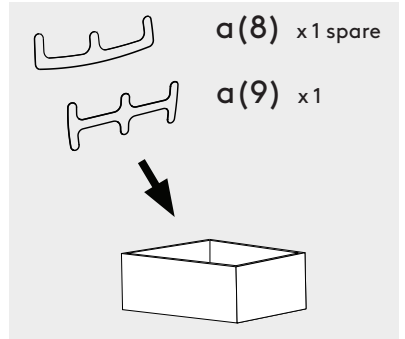
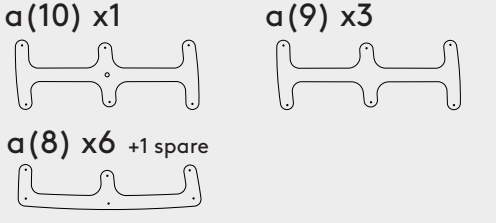

2

Horizontal

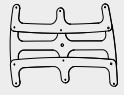
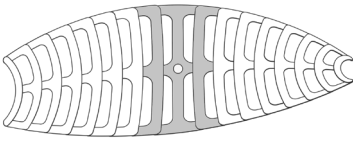

a(10)x1 x1
a(8)x2



a(9)x1 x2
a(8)x2

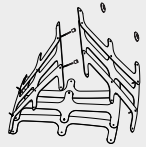
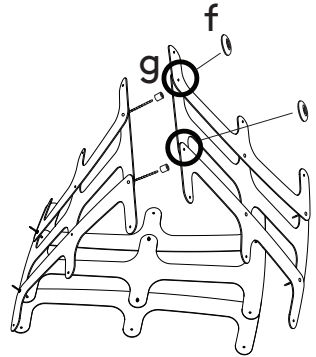
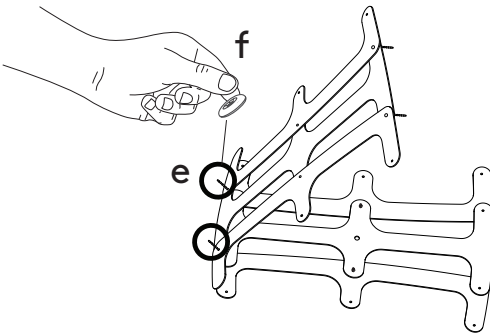
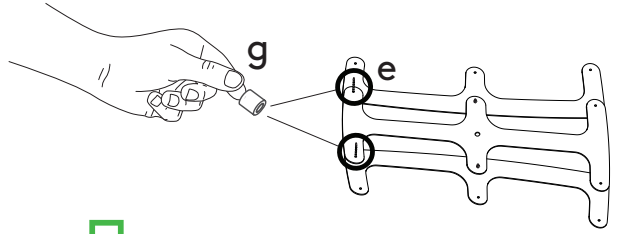

a(9)x1 x2
a(8)x2

a(10)x1 x1
a(8)x2

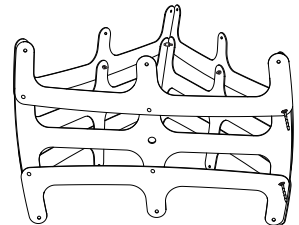
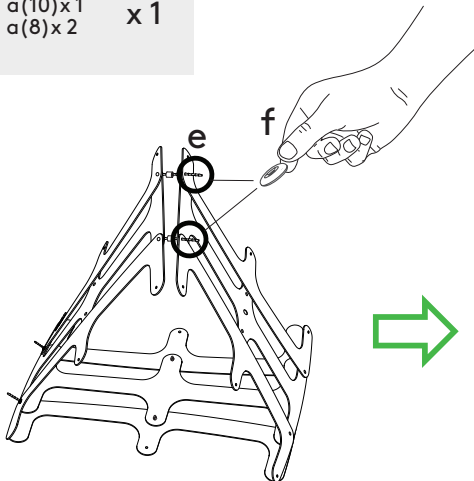

3

Horizontal

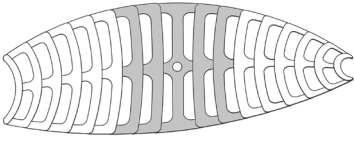

a(7) x6 +1 spare

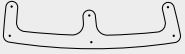

a(7) x1 spare

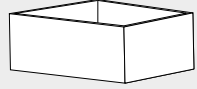

over
Over\ Dessus\
Über\ Encima\
Over\
Sopra

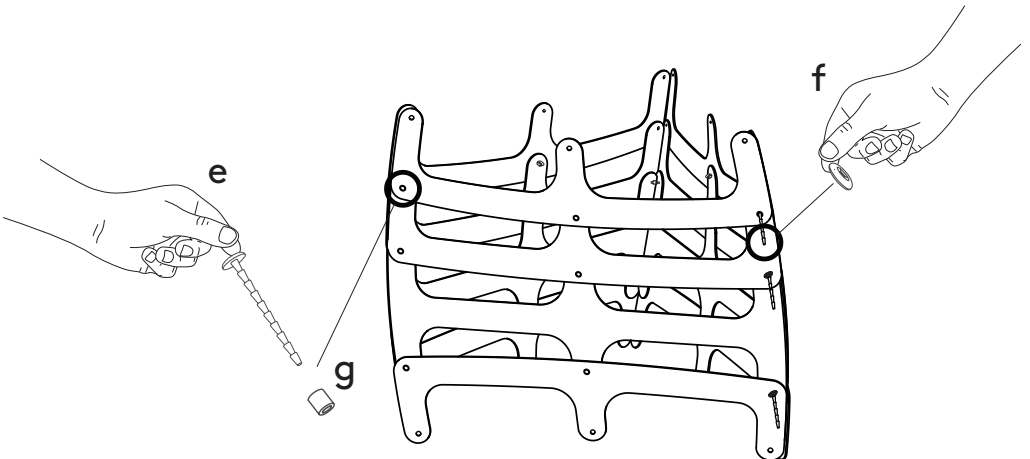
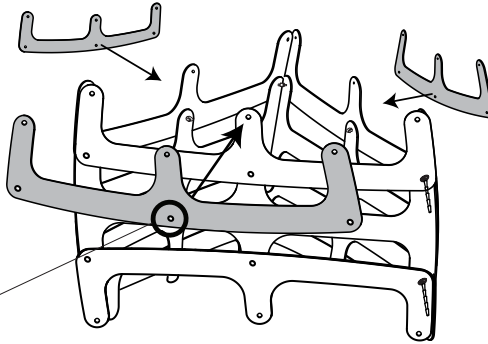

4

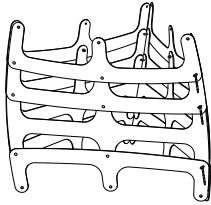
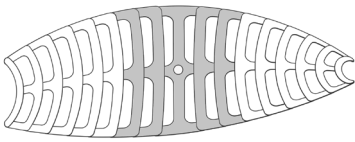

flip-over
Ribaltare\Umdrehen\
Retourner\Vend om\
Dale la vuelta

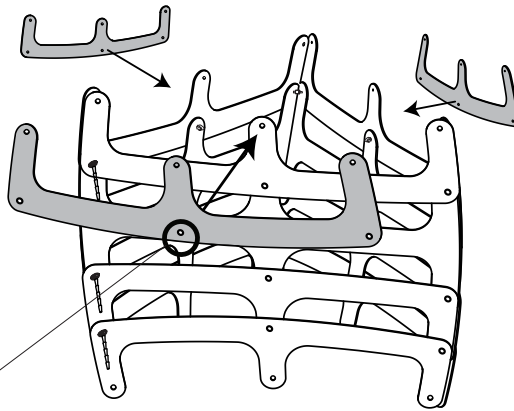
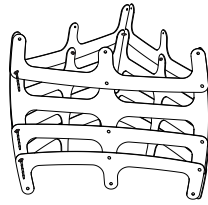

over
Over\Dessus\
Über\Encima\ Over\
Sopra

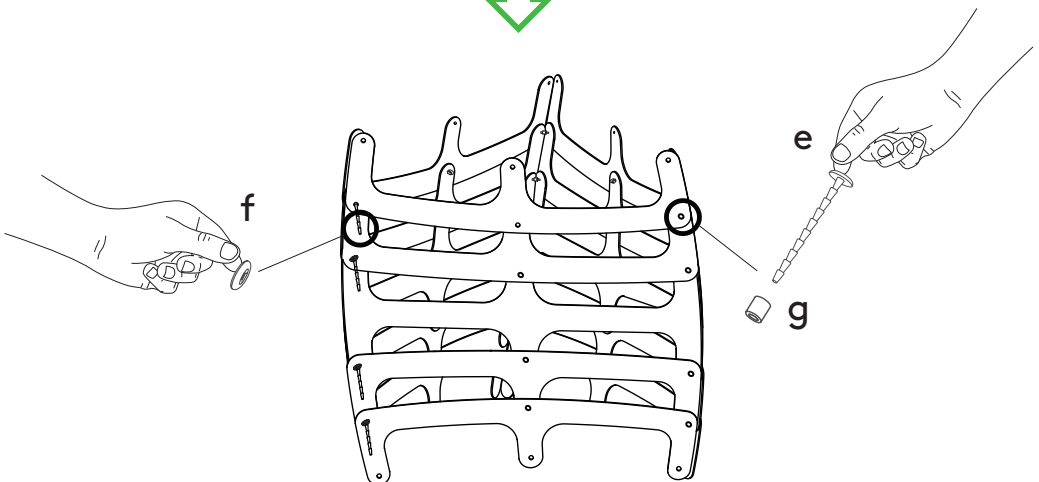

f

e

g

5

Horizontal

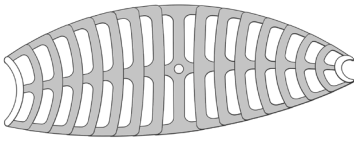

a(6) x6
+ 1 spare

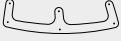

a(4) x6
+ 1 spare



a(2) x6
+ 1 spare



a(5) x6
+ 1 spare

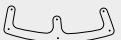

a(3) x6
+ 1 spare

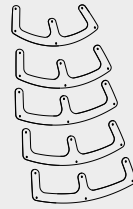

a(2) x1 spare

a(3) x1 spare

a(4) x1 spare

a(5) x1 spare

a(6) x1 spare

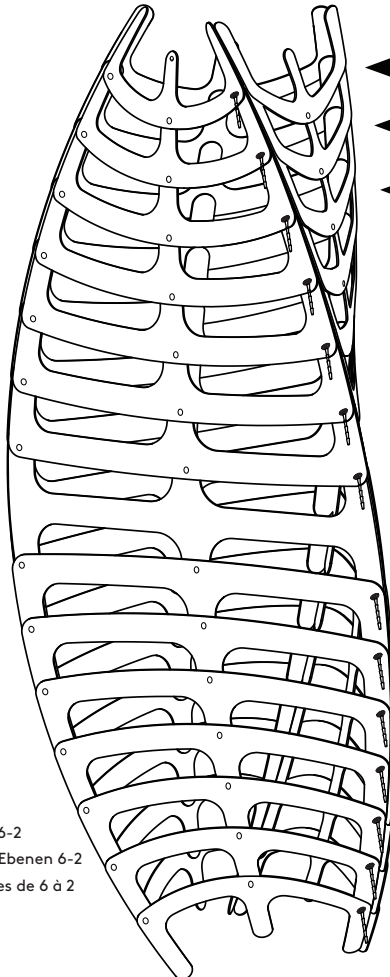

← a(2)

← a(3)

← a(4)

← a(5)

← a(6)

← a(6)

← a(5)

← a(4)

← a(3)

← a(2)

EN - Repeat this process for the layers 6-2

IT - Ripetere questa procedura per gli strati 6-2

DE - Wiederholen Sie diesen Vorgang für die Ebenen 6-2

FR - Répétez le même procédé pour les pièces de 6 à 2

DK - Gentag denne proces for lag 6-2

ES - Repita este proceso para las capas 6-2

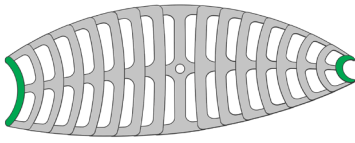

6

Horizontal

a(1) x6 +1 spare



a(1) x1 spare

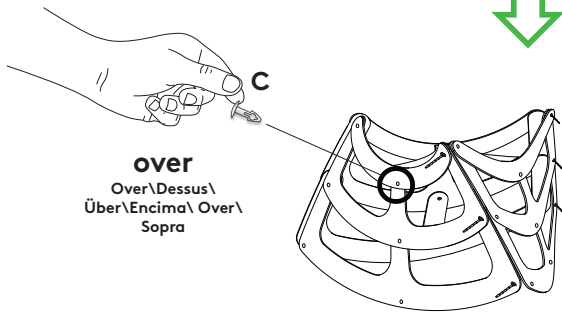
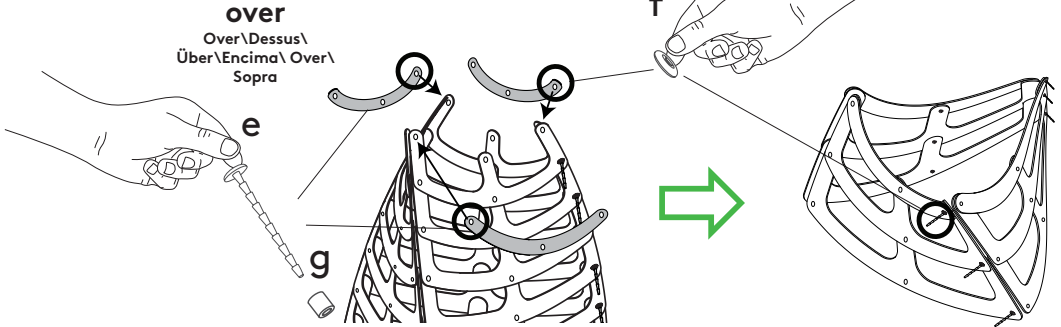
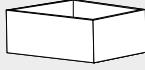

Repeat

Repeat\Ripeti\
Bitte wiederholen\
Gentag\Repite

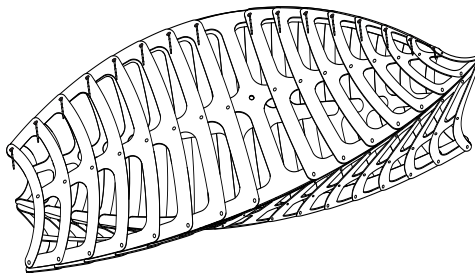

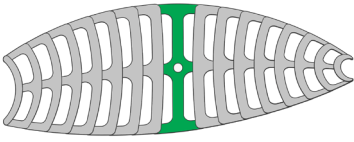

x1



EN - Slide the silicone cover on top the bulb holder

IT - Far scorrere il coperchio in silicone sulla parte superiore del portalampada

DE - Schieben Sie die Silikonabdeckung auf die Lampenfassung

FR - Recouvrir la douille avec la pièce en silicone

DK - Skub silikonafdækningen ovenpå pæreholderen

ES - Empuje la cobertura de silicona en la parte superior del portalámparas

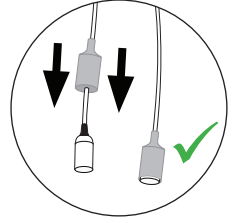

i x1

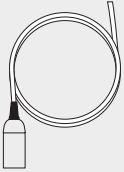

h x1



a(10)

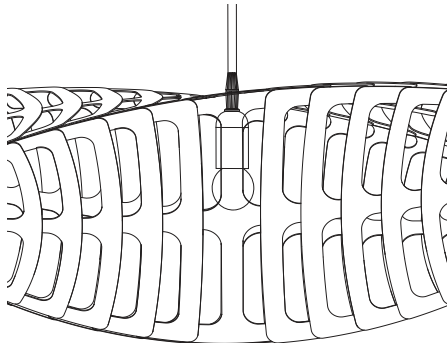
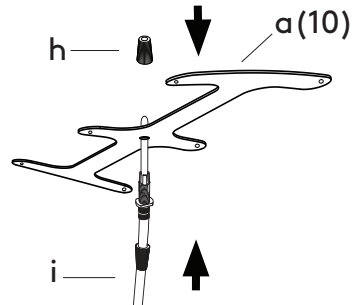
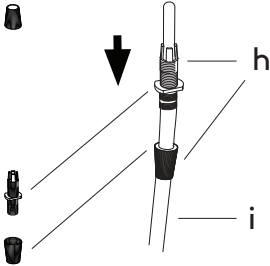
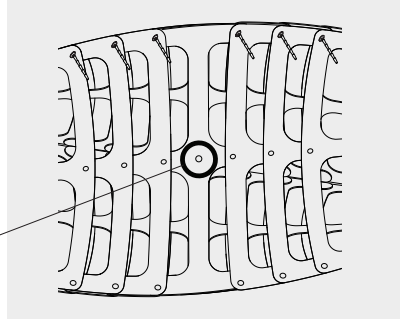

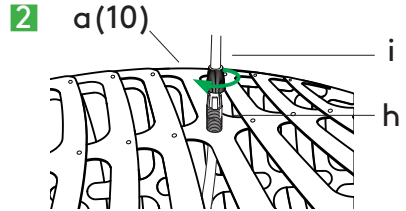
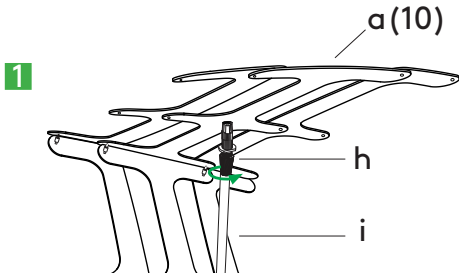
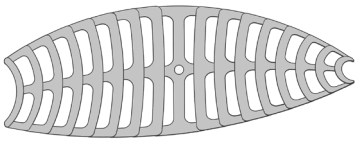

EN - Repeat steps marked 1 and 2 until happy with the position of the light

IT - Ripeti i passaggi contrassegnati con 1 e 2 fino a quando sei soddisfatto della posizione della lampada

DE -Bitte wiederhole die mit 1 und 2 gekennzeichneten Schritte, bis du mit der position der Leuchte zufrieden bist

FR - Répétez les étapes 1 et 2 jusqu'à ce que le luminaire soit orienté comme vous le souhaitez

DK -Gentag trin 1 og 2 indtil du er tilfreds med pendellampens placering

ES - Repite los pasos marcados con 1 y 2 hasta que estés satisfecho con la posición de la luz

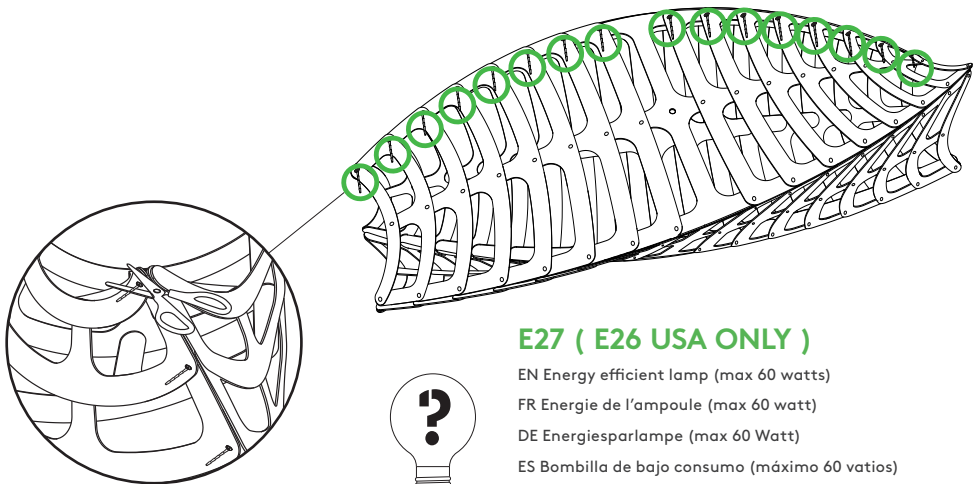

E27 (E26 USA ONLY)

EN Energy efficient lamp (max 60 watts)

FR Energie de l'ampoule (max 60 watt)

DE Energiesparlampe (max 60 Watt)

ES Bombilla de bajo consumo (máximo 60 vatios)

DK Vi anbefaler at bruge energisparepære (max 60 watt)

IT Efficienza energetica della lampada (max 60 watt)



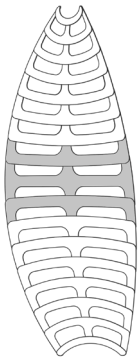

a(10) x1



a(9) x3



a(8) x6 +1 spare



9



Vertical



a(8) x1 spare



a(10)

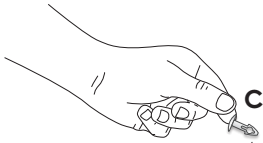
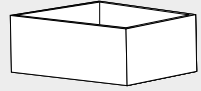

over

Over\Dessus\
Über\Encima\ Over\
Sopra

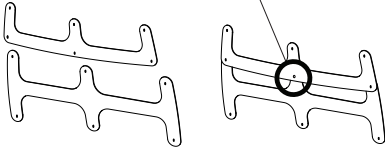

turn clockwise

Girare in senso orario\ Im
Uhrzeigersinn drehen\ Tournez
dans le sens des aiguilles d'une
montre\ Drej med uret

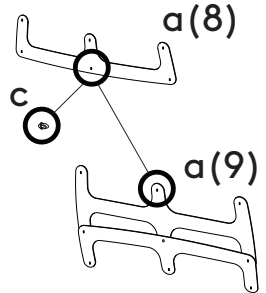

1 x a(9)
2 x a(8)

x 3

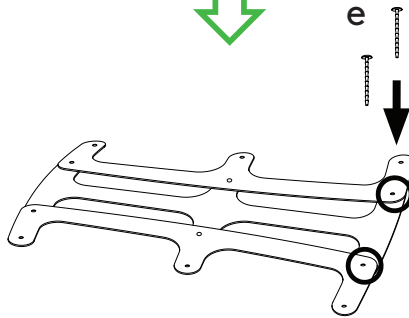

over

Over\Dessus\
Über\Encima\ Over\
Sopra

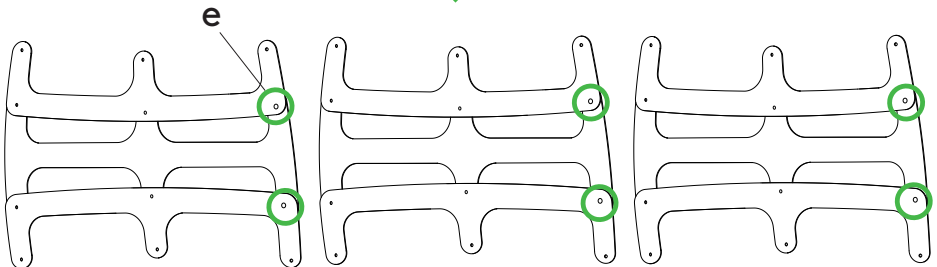

10

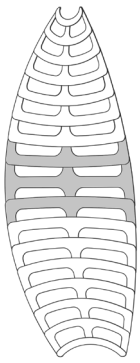

a(9)x1
a(8)x2

a(9)x1
a(8)x2

a(9)x1
a(8)x2

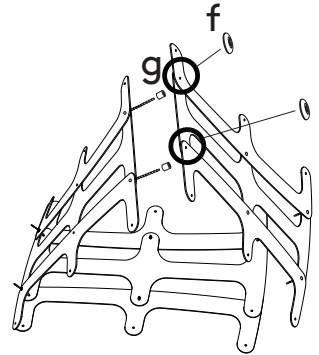
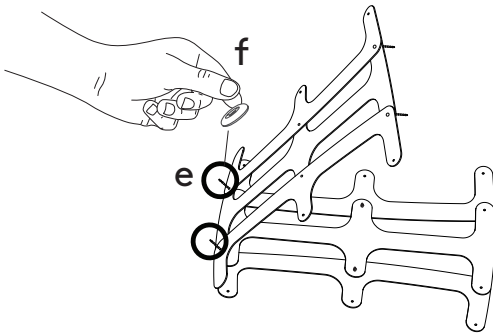
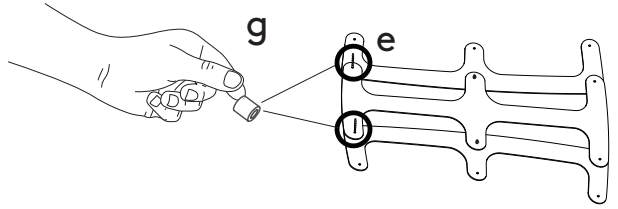

a(9)x1
a(8)x2

x 3

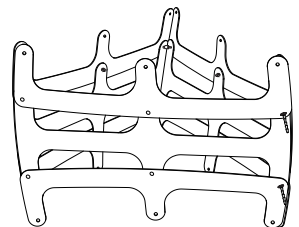
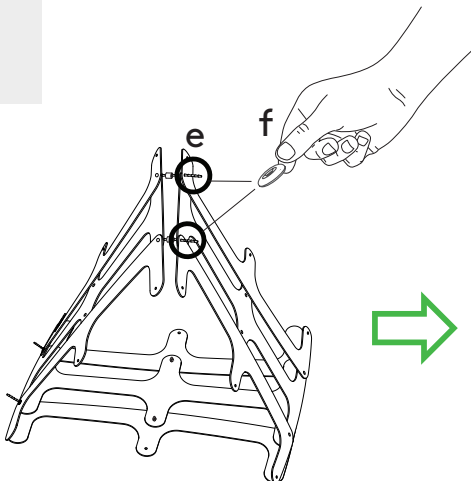

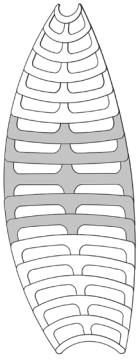

a(7) x6 +1 spare



11

Vertical



a(7) x1 spare

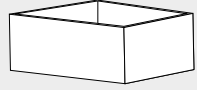

over
Over\ Dessus\
Über\ Encima\ Over\
Sopra

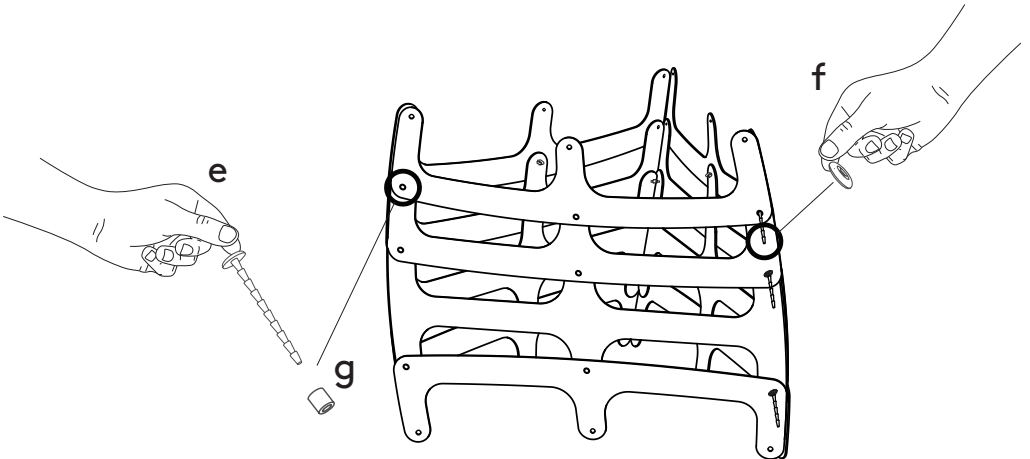
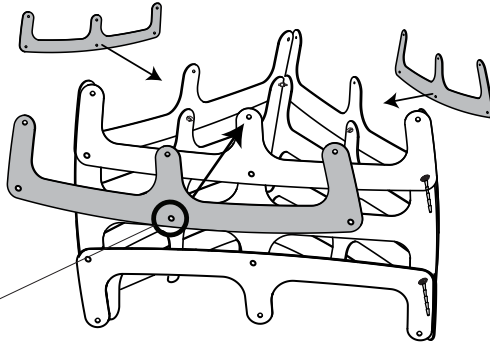

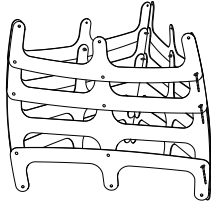
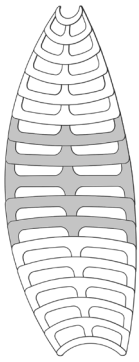

flip-over
Ribaltare\Umdrehen\
Retourner\Vend om\
Dale la vuelta

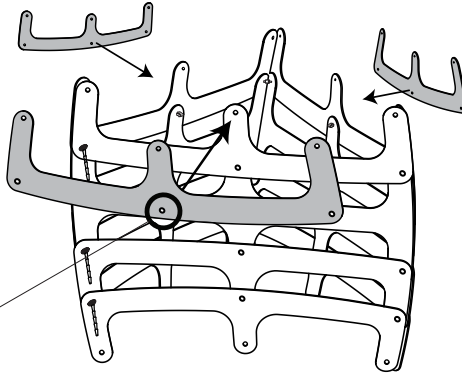
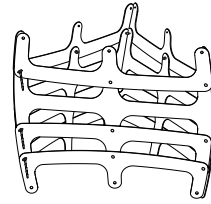

over
Over\Dessus\
Über\Encima\ Over\
Sopra

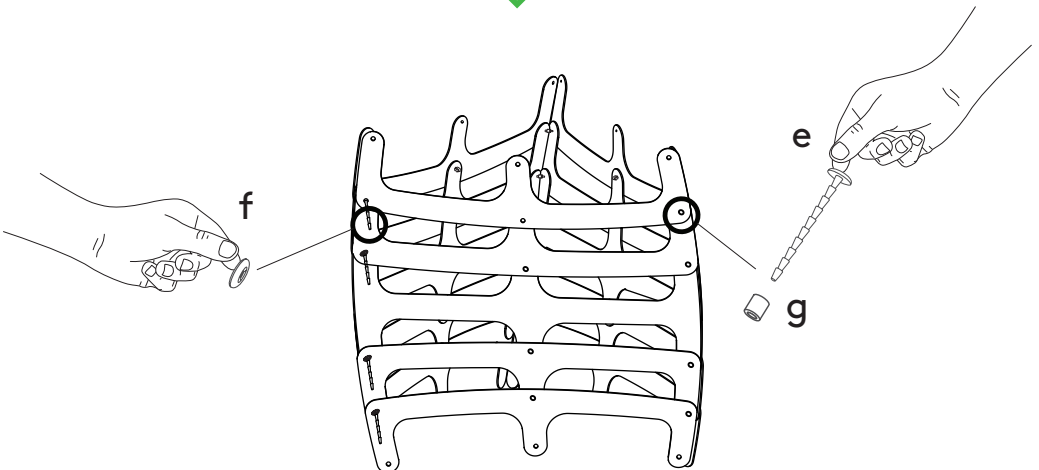

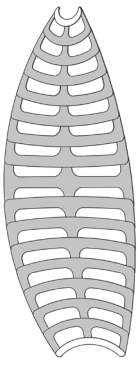

a(6) x6
+ 1 spare

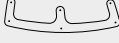

a(4) x6
+ 1 spare



a(2) x6
+ 1 spare



a(5) x6
+ 1 spare



a(3) x6
+ 1 spare

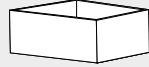
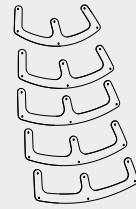

a(2) x 1 spare

a(3) x 1 spare

a(4) x 1 spare

a(5) x 1 spare

a(6) x 1 spare

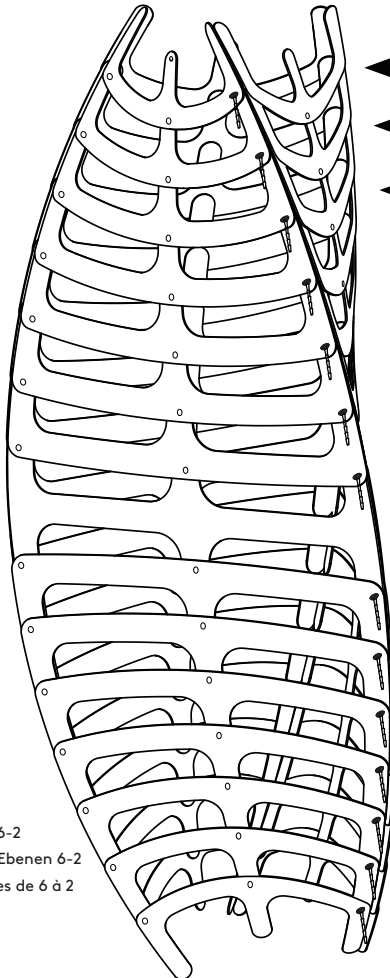

← **a(2)**

← **a(3)**

← **a(4)**

← **a(5)**

← **a(6)**

← **a(6)**

← **a(5)**

← **a(4)**

← **a(3)**

← **a(2)**

EN - Repeat this process for the layers 6-2

IT - Ripetere questa procedura per gli strati 6-2

DE - Wiederholen Sie diesen Vorgang für die Ebenen 6-2

FR - Répétez le même procédé pour les pièces de 6 à 2

DK - Gentag denne proces for lag 6-2

ES - Repita este proceso para las capas 6-2

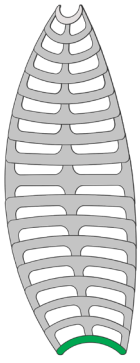

a(1) x3 + 1 spare



14

Vertical



a(1) x 1 spare

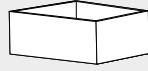

over
Over\Dessus\
Über\Encima\ Over\
Sopra

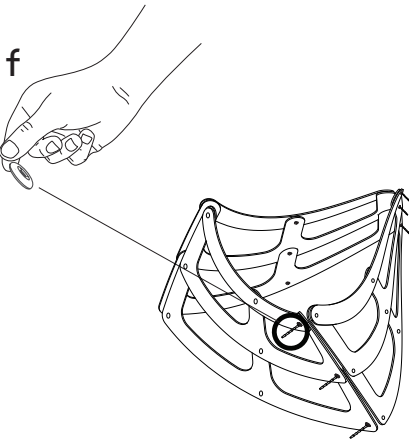
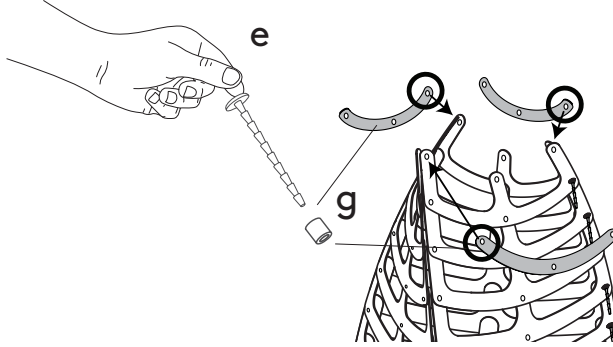

over
Over\Dessus\
Über\Encima\ Over\
Sopra

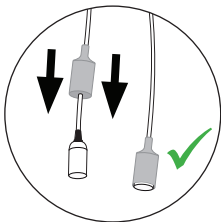
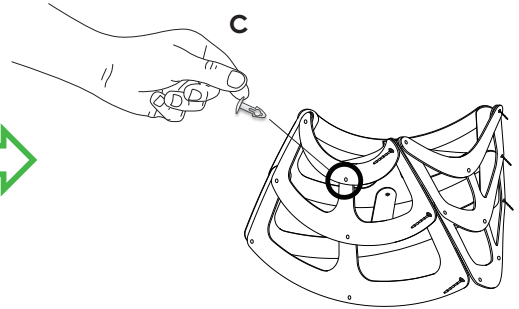

- EN - Slide the silicone cover on top the bulb holder
- IT - Far scorrere il coperchio in silicone sulla parte superiore del portalampada
- DE - Schieben Sie die Silikonabdeckung auf die Lampenfassung
- FR - Recouvrir la douille avec la pièce en silicone
- DK - Skub silikonafdækningen ovenpå pæreholderen
- ES - Empuje la cobertura de silicona en la parte superior del portalámparas

15

Vertical

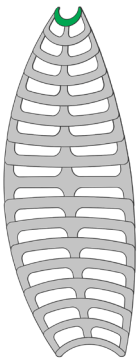

a(1) x3	h x1
i x1	b x1

over
 Over\Dessus\
 Über\Encima\
 Over\
 Sopra

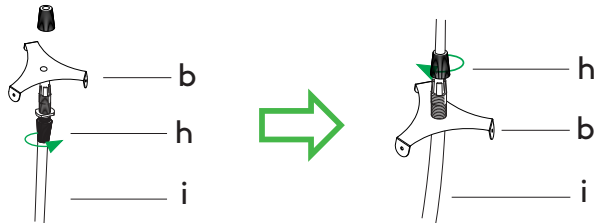
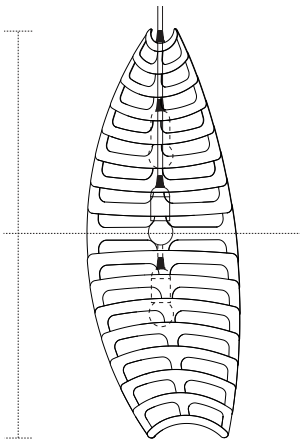
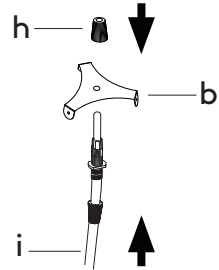
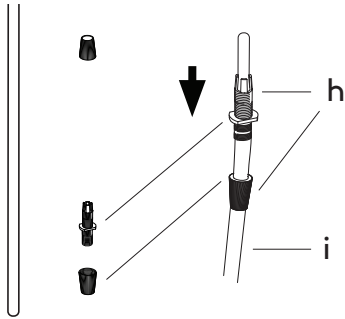
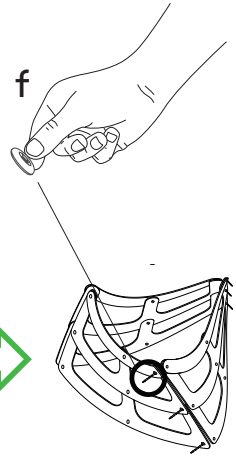
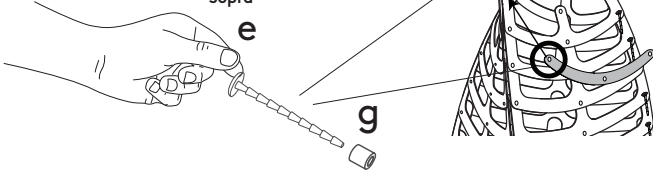

d x3

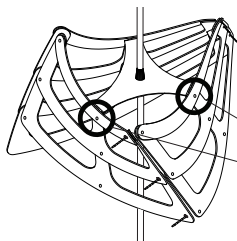
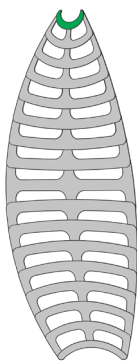

d

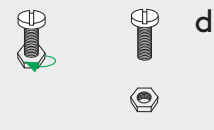

d

over
Over\ Dessus\
Über\ Encima\
Over\
Sopra

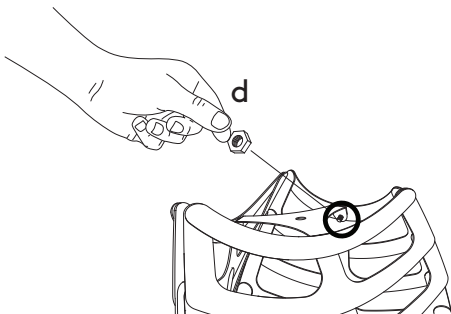

d

under
Under\ Dessous\
Unter\ Bajo\
Under\
Sotto

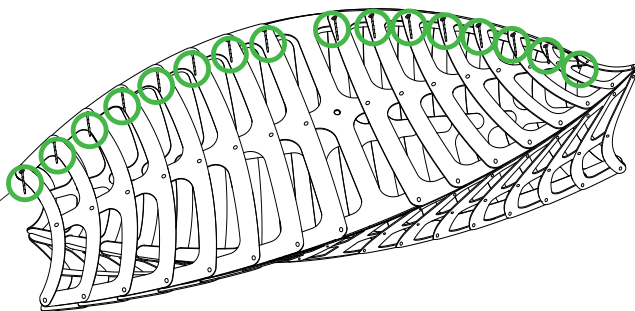
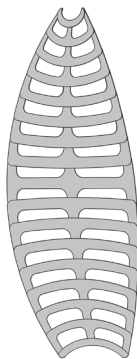
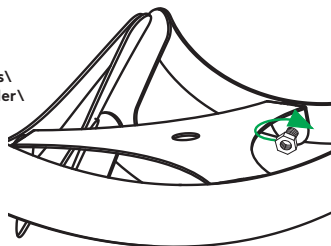

E27 (E26 USA ONLY)

EN Energy efficient lamp (max 60 watts)

FR Energie de l'ampoule (max 60 watt)

DE Energiesparlampe (max 60 Watt)

ES Bombilla de bajo consumo (máximo 60 vatios)

DK Vi anbefaler at bruge energisparepære (max 60 watt)

IT Efficienza energetica della lampada (max 60 watt)



Installation / installazione / Installing / Instalacion

Limited Warranty / Garantie Limitee / Beschränkte Garantie / Garantía Limitada / Begrænset garanti / garanzia limi tata

Care Instructions / Iamanutenion / Pflegehinweise / Instrucciones de cuidado / Vedligeholdelse /manutenzione

Installation / installazione / Installing / Instalacion

EN The light must be installed by a qualified Electrician in accordance with national wiring regulations - DO NOT attempt to install it yourself. A lamp holder with electric cord is included but a lamp is not supplied. TO BE INSTALLED IN DRY INDOOR AREAS ONLY.

FR Le luminaire doit être installé par un électricien qualifié, conformément aux réglementations nationales - Ne l'installez pas vous-même! Une douille et un cordon électrique sont inclus, mais l'ampoule n'est pas fournie. Ce luminaire est conçu pour l'intérieur uniquement.

DE Das Licht muss von einem qualifizierten Elektriker in Übereinstimmung mit nationalen Installationsvorschriften installiert werden - Versuchen Sie NICHT, es selbst zu installieren. Eine Lampenhalterung mit Stromkabel ist im Lieferumfang enthalten, aber eine Birne wird nicht mitgeliefert. Die Lampe nur in trockenen Innenräumen installieren. TO in trockenen Innenräumen installiert werden.

ES La luz debe ser instalada por un electricista cualificado de acuerdo con las regulaciones nacionales de cableado - NO intente instalar la lámpara usted mismo. Un soporte de la lámpara con el cable eléctrico está incluido, pero una bombilla no se suministra. A INSTALAR EN AREAS INTERIORES SECOS.

DK Lyset skal installeres af en autoriseret elektriker i overensstemmelse med nationale forskrifter for elektriske installationer - Forsøg IKKE at installere det selv. En fatning med ledning er inkluderet, men en lyskilde medfølger ikke. UDELUKKENDE TIL MONTERING I INDENDØRS.

IT La lampada deve essere installata da un elettricista qualificato in accordo con le vigenti normative nazionali - non provate a installarla da soli. Un portalampana con cavo elettrico è incluso ma la lampadina non è fornita. DA INSTALLARE SOLO IN AREE INTERNE E ASCIUTTE.

Limited Warranty / Garantie Limitee / Beschränkte Garantie / Garantía Limitada / Begrænset garanti / garanzia limi tata

EN This light is warranted for three years from date of purchase for failure of parts, not including fair wear and tear. Please check now that all parts are present - we can only replace anything missing before assembly.

FR Ce luminaire est garanti pendant trois ans à compter de la date d'achat. La garantie exclue l'usure normale du luminaire (vieillesse naturelle du bois, couleur devenant fade...). Prenez soin de vérifier dès maintenant que toutes les pièces constituant la lampe sont au complet - nous ne remplaçons que les pièces manquantes avant assemblage.

DE Diese Lampe steht für drei Jahre ab dem Kaufdatum für den Defekt von Teilen unter Garantie. Darunter gilt nicht normale Abnutzung. Prüfen sie jetzt, dass alle Teile vorhanden sind - Fehlende oder defekte Teile können nur vor der Montage ersetzt werden.

ES Esta luz tiene una garantía de tres años contados desde la fecha de compra para el fracaso de las partes, sin incluir el uso y desgaste normal. Por favor, comprueba ahora que todas las partes están presentes - sólo podemos reemplazar partes faltantes antes del montaje.

DK Denne lampe er under garanti i tre år fra købsdatoen. Garantien gælder defekte dele, dog ikke grundet almindelig slid og ælde. Kontroller nu, at alle dele er til stede - vi erstatter kun manglende dele før samlesættet samles.

IT La garanzia è di tre anni dalla data di acquisto, è valida per i pezzi rotti o difettosi e non copre il normale deterioramento o i danni. Controllate sin da subito che tutte le parti siano presenti - sostituiamo eventuali pezzi mancanti solo prima dell'assemblaggio del prodotto.

Care Instructions / Iamanutenion / Pflegehinweise / Instrucciones de cuidado / Vedligeholdelse /manutenzione

EN All wooden and/or polycarbonate lights are intended for use in dry interior conditions only, and can be cleaned with a soft cloth dampened in warm water when light is switched off.

FR Tous nos luminaires en bois et / ou polycarbonate sont destinés à un usage en intérieur uniquement. Ils peuvent être nettoyés avec un chiffon légèrement trempé dans de l'eau tiède savonnée (éteindre la lampe avant de la nettoyer).

DE Alle Holz- und / oder Polycarbonat-leuchten sind nur für den Einsatz in trockenen Innenbereichen vorgesehen und wenn das Licht ausgeschaltet ist, kann diese mit einem weichen Tuch mit warmen Seifenwasser gereinigt werden.

ES Todas las luces de madera y / o de policarbonato están diseñados para uso en zonas interiores secas solamente, y se pueden limpiar con un paño suave humedecido en agua tibia con jabón cuando la luz está apagada.

DK Alle træ-og/eller polycarbonat lamper er beregnet til brug indendørs, og kan rengøres med en blød klud fugtet i varmt sæbevand, når lyset er slukket.

IT Istruzioni per la cura e manutenzione: Tutte le lampade in legno e/o policarbonato sono progettate soltanto per uso interno con ambienti asciutti e possono essere pulite con un panno morbido inumidito in acqua tiepida e sapone, avendo cura di spegnere la luce della lampada per la pulizia.

Join our Community:



davidtrubridge/newsletter