

Fall Detection System Using Combination Accelerometer and Gyroscope

Quoc T. Huynh¹, Uyen D. Nguyen¹, Su V. Tran¹, Afshin Nabili², Binh Q. Tran²

¹School of Electrical Engineering, International University - Vietnam National University – Hochiminh City, Vietnam

²Department of Biomedical Engineering, School of Engineering, Catholic University of America

Abstract- Falling is a common accident and the most significant cause of injury for elderly person. This study investigates the methodology to identify falls from normal Activities of Daily Living (ADLs). In this study, a wireless sensor system (WSS), based on accelerometer and gyroscope, is placed at the centre of the chest to collect real-time fall data. The WSS contains a set of ADXL345 (3-axis digital accelerometer sensor), ITG3200 (3-axis digital gyroscope sensor), MCU LPC17680 (ARM 32-bit cortex M3), and Wi-Fi module RN131. Experiment protocols consisting of four types of falls such as forward fall, backward fall, and side way fall (left and right) along with normal gait involved 324 tests on 18 human subjects. The results from the experiment shows the system and algorithm could distinguish between falling and ADLs with an accuracy of 99.382%.

Keywords— Fall Detection, Activities of daily living, Wireless sensor system.

I. INTRODUCTION

Fall is the most significant causes of injury for elderly. These falls are cause many disabling fractures that could eventually lead to death due to complications, such as infection or pneumonia. More than one-third of elderly people, who is over 75 year old, have fallen at least once a year, and 24% of them has serious injuries [1]. For this reason, fall detection is an active area of research. Most of the research on falls in which accelerometers is used focus on determining the change in magnitude of acceleration. When the acceleration value exceeds a critical threshold, the fall is detected [2] [3]. These systems successfully detect falls with sensitivities greater than 85% and specificities between 88-94%. However, focusing only on large acceleration can result in many false positives from fall-like activities such as sitting down quickly and running.

Some fall detection algorithms also assume falls happen when the body lies prone on the floor. But they are less effective when a person's fall posture is not horizontal, e.g. fall happen on stair.

Furthermore, previous studies used complex algorithms like support vector machine (SVM) [4] and Markov models [5] to detect the fall. However, accuracy of these systems has not been proven to be highly effective. They also use excessive amounts of computational resources and cannot respond in

real time. In addition, fall activity patterns are particularly difficult to obtain for training systems.

Unlike other previous research, this project proposes using both accelerometer and gyroscope sensors to detect the falls for increasing the sensitivities and specificities of a fall detection system

II. METHODOLOGY

- A. In this study, we developed a wireless sensor system and an algorithm to identify the fall events compared to normal ADLs. The system includes a Wireless Sensor System (WSS) and a detection algorithm. Figure1 shows the overall schematic of system. The WSS transmits and receives real-time accelerometer and gyro data during the fall. The detection algorithm is based on a simple threshold method.

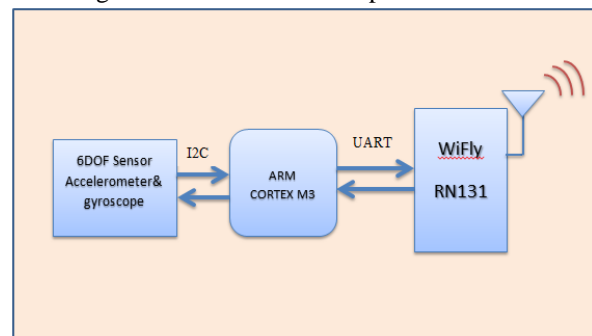

Figure 1. The schematic of wireless sensors system

A. Wireless sensor system (WSS)

The wireless sensors system contains a set of Sensor module, Micro Control Unit, and Wi-Fi module. The Sensor Module, the Micro Control Unit, and the Wi-Fi module are used to sense body orientation and activity data, control the flow of data, and transmit/receive data, respectively. The WSS is placed at the center of chest, see Fig 2.c.

1. Sensor Module

Since our system measures both acceleration and angular velocity to detect falls, we chose to use the 6-DOF module with small size and power requirements. It includes a tri-axial accelerometer ADXL345 and a tri-axial gyroscope ITG3200 (Fig 2.a). The acceleration measurement range of ADXL345,

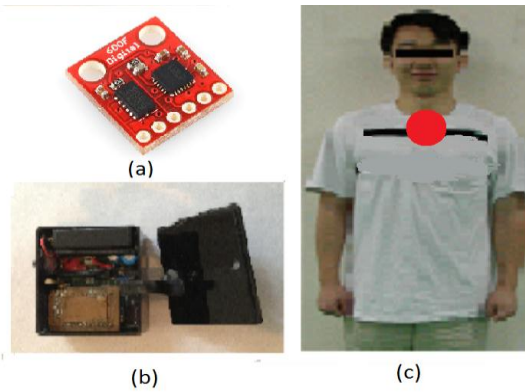

Figure 2. Fall detection system: (a) sensor module (6 DOF), (b) wireless sensor system (WSS), (c) system attached on center chest.

with a high resolution of 13bit and 4mg/LSB, is up to $\pm 16g$. This is an important aspect in recognizing the fall. In addition to the accelerometer, the ITG-3200 can capture the angular velocity between $\pm 2000^\circ/\text{sec}$. The digital data output of these modules is formatted as 16 bits two complements prior to transmitting. The sensor modules are connected with MCU via I2C digital interface port.

2. The Micro Control Unit (MCU) module (ARM 32 bit Cortex M3)

The LPC 1786 (NXP product's) is used to develop the control system. This is an ARM Cortex-M3 32-bit based microcontroller for embedded applications requiring a high level of integration and low power dissipation. The chip can operate up to 100MHz CPU frequency. In addition, the UART interface provides the sampling frequency up to 4Mb/s.

3. Wireless module

The Wifly RN131 module is a stand-alone Wi-Fi module, providing a fully integrated 2.4GHz and IP stack with IEEE 802.11 b/g standard. The RN131 can operate with the communication speed up to 11 Mbps. Due to its small form factor and extremely low power consumption; it is perfect for

mobile wireless applications with portable battery operated devices. Additionally, its UART hardware interfaces for connecting with MCU can operate up to 1 Mbps data rate.

4. Collection data program

The WSS (Fig.2,b) consists of 6-DOF, MCU and Wi-Fi module. The MCU is connected to wireless module via UART port and 6DOF module via I2C port. The WSS collects the acceleration and angular velocity values. In addition, the WSS sends the real-time data to a computer via 802.11 wireless protocols to be displayed.

The collection data program is written in Matlab (Mathworks, Inc, Natick, MA). The program receives and display real-time data from the WSS. It continuously plots the acceleration and angular velocity values of each fall and saves the data for later analysis. Figure 3 (below) shows a display of the collection data program.

B. Fall detection algorithm

The parameters used in analyses are similar to previous studies [3] [6]. The total sum acceleration vector Acc , contain both dynamic and static acceleration components, is calculated from sampled data as indicated in Eq. (1)

$$Acc = \sqrt{(A_x)^2 + (A_y)^2 + (A_z)^2} \quad (1)$$

Where A_x, A_y, A_z is the acceleration (g) in the x, y, z axes, respectively.

Similarly to the acceleration, the angular velocity is calculated from sampled data as indicated in Eq. (2)

$$\omega = \sqrt{(\omega_x)^2 + (\omega_y)^2 + (\omega_z)^2} \quad (2)$$

Where $\omega_x, \omega_y, \omega_z$ is the acceleration (g) in the x, y, z axes, respectively.

When stationary, the acceleration magnitude, Acc , from tri-axial accelerometer is a constant +1g, and angular velocity is $0^\circ/\text{s}$. When the subject falls, the acceleration is rapidly changing and the angular velocity produces a variety of signals along fall direction. The lower and upper fall

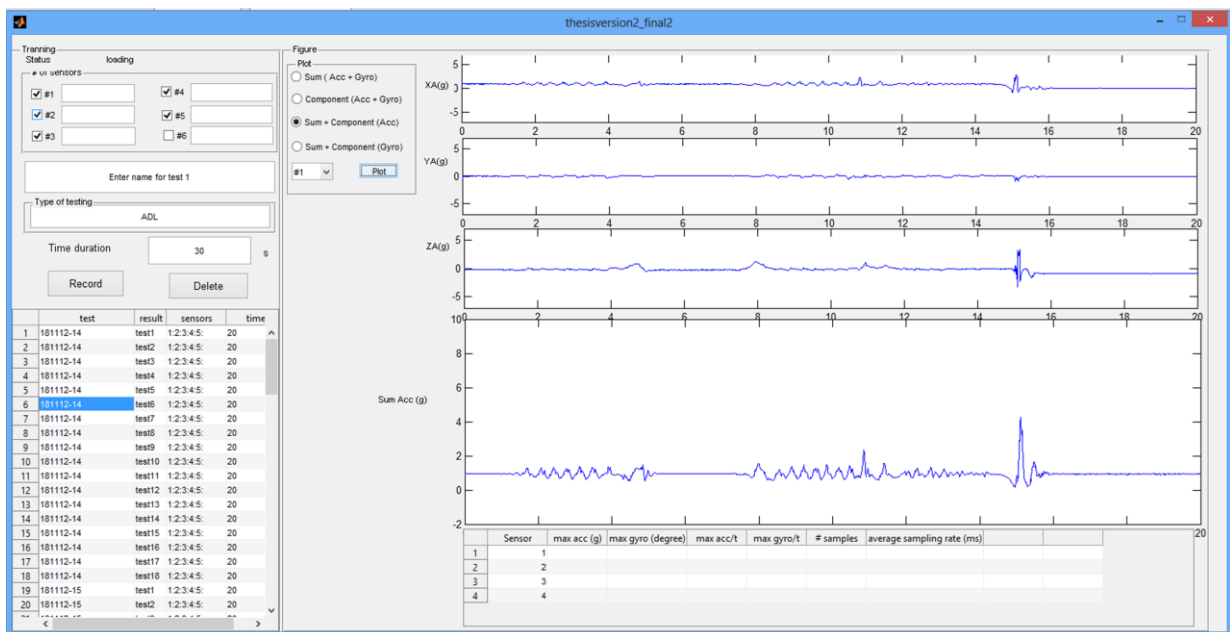

Figure 3. The collection data program

thresholds for the acceleration and angular velocity used to identify the fall are derived as follows [7]:

- Lower fall threshold (LFT): the negative peaks for the resultant of each recorded activity are referred to as the signal lower peak values (LPVs). The LFT for the acceleration signals are set at the level of the smallest magnitude lower fall peak (LFP) recorded.
- Upper fall threshold (UFT): the positive peaks for the recorded signals for each recorded activity are referred to as the signal upper peak values (UPVs). The UFT for each of the acceleration and the angular velocity signals were set at the level of the smallest magnitude UPV recorded. The UFT is related to the peak impact force experienced by the body segment during the impact phase of the fall.

Fall detection algorithms using thresholds are normally divided into two groups, one is based on the LFT comparison and the other is based on UFT comparison of acceleration data. Although past research has achieved some significant results, the accuracy is still below desired levels. For example, A.K Bourke [8] used UFT and LFT and found the performance to be 83.33% and 67.08%, respectively.

In this study, we use both the LFT and UFT of the acceleration in the combination with the UFT of the angular velocity to perform the fall detection. The flowchart of our algorithm is summarized in Fig.4.

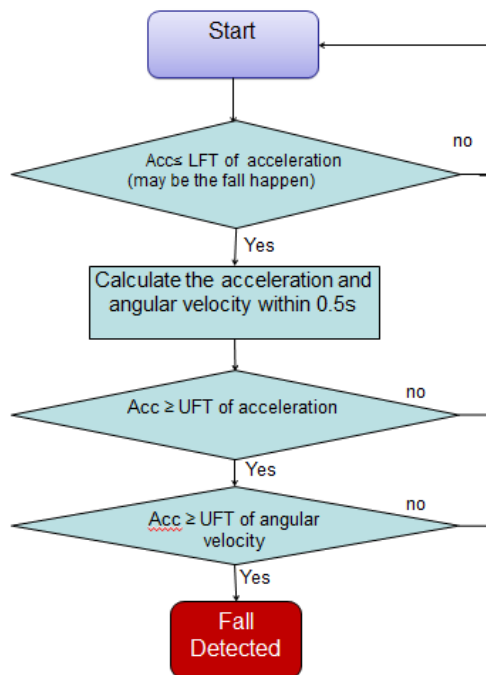

Figure 4. Fall detection schema.

The algorithm involves the following steps: Firstly, we determine the LFT and UFT for both the acceleration and angular velocity based on the collected data. Secondly, we calculate the acceleration vector and compare it to the LFT. Finally, at the instant when the acceleration vector falls below the LFT threshold, we compare the next 0.5s of data to the UFT for both the acceleration and angular velocity vector. The 0.5s is assumed to be the fall duration. If both the

acceleration vector and the angular velocity vector are above the UFT, then fall is detected.

C. Experimental setup

The experiment is performed on 18 young healthy subjects (age from 19 to 28 years, weight from 50 to 90 kg, and height from 154.5 to 180.0 cm). Experiments were performed at The Catholic University of America (Washington, DC) and approved by the Human Subjects/Institutional Review Board (IRB) Committee. The WSS was attached to the center of the chest (Fig. 1.c.). This is the optimum location to attach sensor for fall detecting as mentioned in our previous study [9]. In this experiment, subject performs ADL such as standing, walking, sitting down/ standing up, step, run, and 4 different kinds of fall tests: forward fall, backward fall, right sideway fall, and left sideway fall.

III. RESULTS AND DISCUSSION

There are 324 tests collected from 18 subjects. Figure 5 shows a typical example of the acceleration (Fig.5a.) and angular velocity signals (Fig5.b) during stand, walk, sit down/stand up, step and fall. Fig. 5 shows that for a normal ADL (such as stand, walk, sit down, stand up, and stepping) we can easily detected fall by using just UFT and LFT of accelerometer.

However, Fig.6 shows that for a high density ADL (such as running) and using the UFT and LFT might misidentify the act of running as fall. This is due to the range of acceleration vector of running exceeds UFT and falls below LFT, see Table 1. Similarly, Fig. 7 shows using only UFT of the angular velocity might misidentify the act of turning and twisting, such as sitting up or lying back, as falls. To eliminate the possibility of misidentify high density ADL, turning, or twisting, as fall; we combine the accelerometer with the gyroscope to improve the accuracy of the system.

The table 1 shows the summary of acceleration and angular velocity of ADL and fall. Based on results, the LFT of acceleration, UFT of acceleration, and the UFT of angular velocity are set as 0.3g, 2.5 g, and 200⁰/s, respectively.

The sensitive and the specificity of the system are defined as follows:

$$\text{Sensitivity} = \frac{\text{No.TP}}{\text{No.TP} + \text{No.FN}} \quad (3)$$

$$\text{Specificity} = \frac{\text{No.TN}}{\text{No.TN} + \text{No.FP}} \quad (4)$$

Where:

- Number of True positive (No.TP): a fall occurs, the device detects it.
- Number of False positive (No.FP): the device announces a fall, but it did not occur.
- Number of True negative (No.TN): a normal (no fall) movement is performed, the device does not declare a fall.
- Number of False negative (No.FN): a fall occurs but the device does not detect it.

The result of 324 tests shows the sensitivity of the system is 100% and the specificity of system is 99.382%. Compared to other algorithms for fall detection, our algorithm has shown to have a higher sensitivity and specificity. The proposed method is a simple threshold method; therefore, it could be easily ported onto an electronic device worn by a person.

One of the limitations of this study is that young subjects performed the tests. Therefore, the young subjects might not be able to simulate the actual fall of the elderly. Therefore, the LFT and UFT values of the real condition could be significantly different than our findings. Further research is required to actually identify the correct threshold values for LFT and UFT.

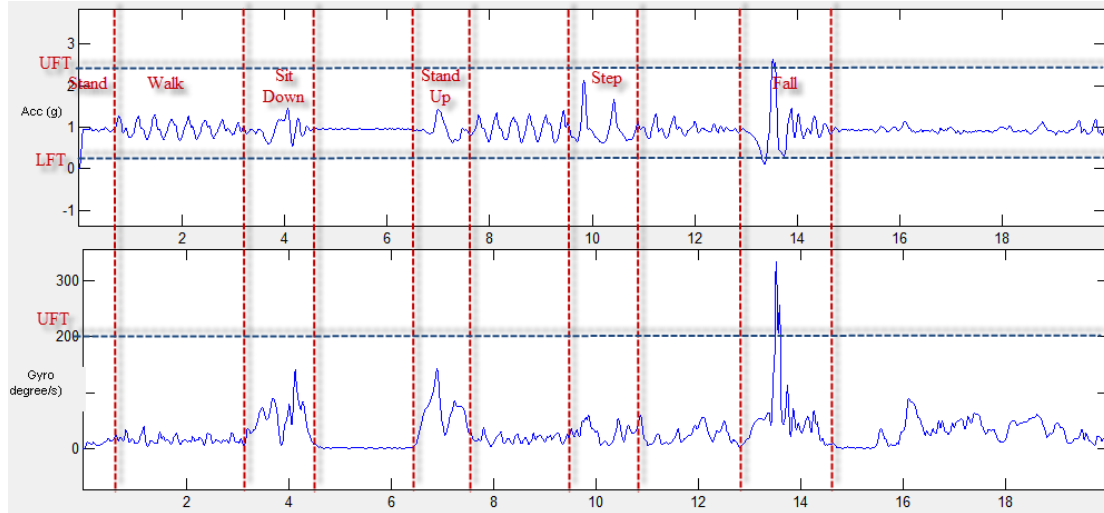

Figure 5. The signal for standing, walking, sitting down/standing up, stepping and falling. (a)The sum of acceleration Acc.(b)The sum of angular velocity ω .

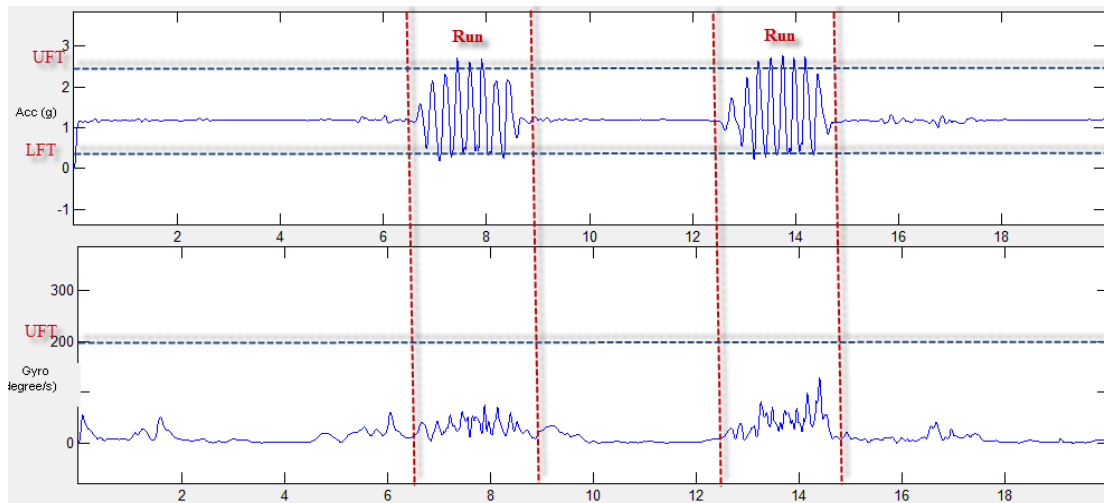

Figure 6. The signal for running.(a)The sum of acceleration Acc.(b)The sum of angular velocity ω .

Activities	Negative peak acceleration (g)	Positive peak acceleration (g)	Positive peak angular velocity ($^{\circ}$ /s)
Stand	0.98	1	0
Walk	0.55-0.6	1.5-1.9	10-20
Sit down/stand up	0.47-0.58	1.6-2.1	50-170
Lie	0.6-0.85	1.3-1.7	130-260
Step	0.3-0.45	1.8-2.3	40-80
Run	0.2-0.34	2.3-2.8	60-120
Fall	0.15-0.3	2.5-5.4	200-320

Table 1: Summary of acceleration and angular velocity of ADL and fall.

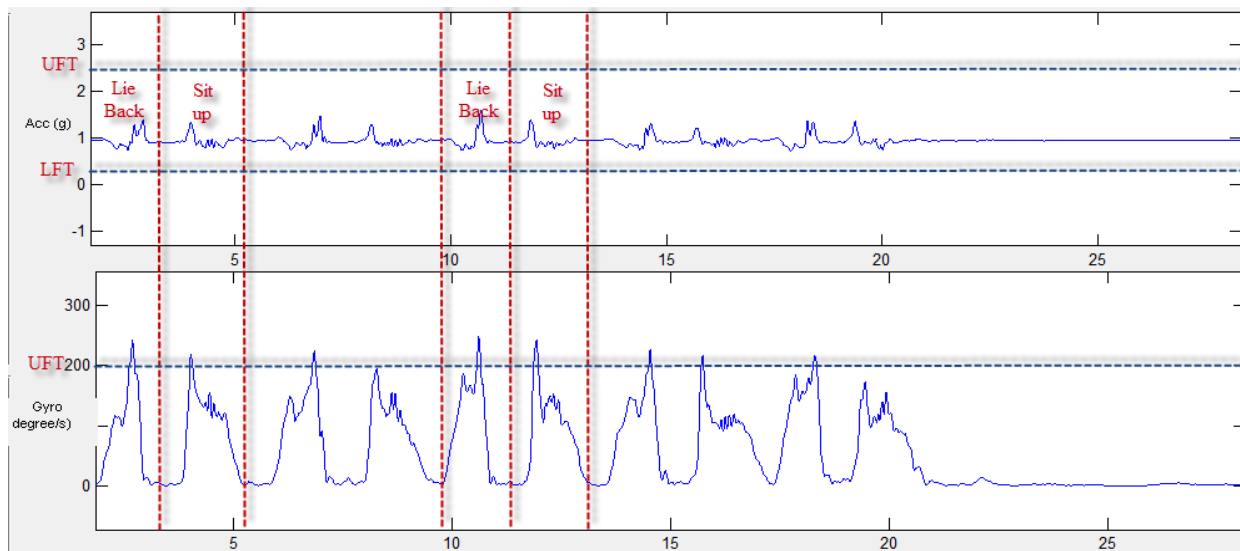

Figure 7. The signal for lying back, sitting up.(a)The sum of acceleration Acc.(b)The sum of angular velocity ω .

IV. CONCLUSION AND FUTURE WORK

In this study, a wireless sensor system is implemented to measure the acceleration and angular velocity at center chest on the body for four different types of fall. The collected data is used to evaluate the performance of the fall detection algorithm. There are many fall detections systems investigated in previous studied. However, to increase the accuracy, we proposed a combination of accelerometer and gyroscope simultaneously. As the results, we have improved the accuracy, specifically the specificity and the sensitivity to 99.384% and 100%, respectively. We also have used small battery operated devices, which can be easily woven into garments.

In conclusion, a fall detection system has been validated to show high sensitivity and specificity results, using the combination of accelerometer and gyroscope. Future development will investigate a system to include GPS and GPRS to inform medical attention. Furthermore, an algorithm that can distinguish ADL such as walking, standing, sitting down/ standing up, running, and jumping will also be investigated.

References

- [1] J.Y. Hwang, J.M Kang, H.C. Kim, "Development of novel algorithm and real-time monitoring ambulatory system using Bluetooth module for fall detection in the elderly," pp. 2204-2207, September 1-5, 2004.
- [2] U.Lindeann, A.Hock, M.Stuber, W.Keck, and C.Becker, "Evaluation of a fall detector based on accelerometers: A pilot study," *Medical and Biological Engineering and Computing*, p. 43, Oct 2005.
- [3] M. Kangas, A. Konttila,P. Lindgren, I. Winblad, T. Jämsä, "Comparison of low-complexity fall detection algorithms for body attached accelerometers.," *Gait & Posture*, Vol.35, pp. 500-505, 2008 Feb 21.
- [4] Tong Zhang, Jue Wang, Liang Xu, Ping Liu, "Fall Detection by Wearable Sensor and One-Class SVM," *Proceedings of the 26th Annual International Conference of the IEEE EMBS*, pp. 2204-2207, 2004.
- [5] P. Jayachandran, T.F. Abdelzaher, and J.A. Stankovic R. K. Ganti, "SATIRE: A software architecture for smart attire," *Proceedings of MobiSys'06*, 2006.
- [6] J. Klenk, C. Becker, F. Lieken, S. Nicolai, W. Maetzler, W. Alt, W. Zijlstra, "Comparison of acceleration signals of simulated and real-world backward falls," in *Medical Engineering & Physics*, VOL.33, 5 November 2010, pp. 368-373.
- [7] A.K. Bourkea, K.J. O'Donovan, G. ÓLaighin, "The identification of vertical velocity profiles using an inertial sensor to investigate pre-impact detection of falls," in *Medical Engineering & Physics*, VOL.30, September 2008, pp. 937-946.
- [8] A. K. Bourke, P.van de Ven, M. Gamble, R. O'Connor, K. Murphy, E. Bogan, E. McQuade, P. Finucane, G.OLaigin, J. Nelson, "Evaluation of waist-mounted tri-axial accelerometer based fall-detection algorithms during scripted and continuous unscripted activities," *Journal of Biomechanics*, pp. 3051-3057, 2006.
- [9] Quoc T. Huynh, Uyen D. Nguyen, Su V. Tran, Binh Q. Tran, "Optimum Location for Sensors in Fall Detection," *International Conference on Green and Human Information Technology*, Feb. 2013.
- [10] K.M. Culhane, G.M. Lyons, D. Hilton,P.A. Grace, D. Lyons, "Long-term mobility monitoring of older adults using accelerometers in a clinical environment," in *Clinical Rehabilitation*, 2004, pp. 335-343.
- [11] M.N. Nyan,F.E.H. Tay, A.W.Y. Tan , K.H. Seah, "Distinguishing fall activities from normal activities by angular rate characteristics and high-speed camera characterization.," in *Medical Engineering & Physics*, VOL.28, Epub, 2006 Jan 6, pp. 842-849.