

# A novel method for measurement of terminal velocity of Aerodynamic Decelerators

Mahboob Ahmed, Surendra M. Jain, Deepak Kumar, Alok Jain

**Abstract**— Measurement of terminal velocity of aerodynamic decelerators is of paramount importance for their optimal design. In this paper, various methods being used for terminal velocity measurement and their pros and cons are discussed in brief. It also presents a novel instrumented plumb line method for terminal velocity measurement. The details of implementation of proposed scheme of terminal velocity measurement and test results are also discussed in this paper.

**Keywords**- Aerodynamic decelerator, Strain Gauge, load Link, Terminal Velocity, Rate of descent.

## I. Introduction

Aerodynamic decelerators are used for safe landing of payloads and paratroopers. Many applications are being developed where decelerators play an important role in the systems like CADS (Controlled Aerial Delivery System), Heavy Drop Systems (for delivering the military stores & articles of daily use), Armament delivery systems, etc. In all of these applications, main objective of designing the decelerator is to provide minimum possible 'g' loading during its deployment and achieve optimized terminal velocity for the safety of the goods which are being dropped. Terminal velocity is achieved when system comes in steady state. This is the velocity at which system hits the ground. High terminal velocity may cause damage to the payloads or paratroopers. So it is considered as one of the main design parameters of aerodynamic decelerators.

Various techniques are being used for measurement of the terminal rate of descent. Amongst all of these, Pressure based terminal velocity measurement technique is very common. But during various instrumented trials for performance evaluation of parachutes, it has been found that, due to wake effect, terminal velocity measurements are not always very accurate. To overcome this problem, an instrumented plumb line based terminal velocity measurement is proposed in this paper. The proposed scheme has been used in instrumented trials for measurement of terminal velocity and has produced satisfactory results. Pressure sensor is also used and mounted in possible wake free zone to cross check the data. These two terminal velocity measurements were again verified using videography techniques.

Mahboob Ahmed, Surendra M. Jain, Deepak Kumar, Alok Jain  
Aerial Delivery Research & Development Establishment, Agra  
India

## II. Conventional Methods

### A. Pressure-based

In airborne trials of performance evaluation of aerodynamic decelerators, Dummy Payload is being dropped from an altitude, ranging from 1000ft to 10000ft using aircrafts/helicopters. During its descent, there is variation of pressure which is related to altitude [1]. Barometric pressure varies with the altitude as given in the following equation.

$$H=288.15/0.0065 (1 - (P/1013.25)^{0.0065 *R/g}) \quad (1)$$

Where, H is altitude in m, P is Pressure in mbar, R is Universal gas constant and 'g' is  $9.81 \text{ m/s}^2$

As altitude increases, pressure decreases or vice versa. When aerodynamic decelerators along with payload are dropped from an altitude, rate of altitude decrement is increased initially. As soon as decelerators start deploying, it experiences deceleration force which reduces the rate of descent of the parachute system. When decelerators attain steady state condition then its rate of descent becomes constant which is called terminal velocity or rate of descent.

Using barometric pressure sensor, pressure variation during the instrumented parachute trials is recorded; recorded data is processed using LabVIEW. Using the standard relationship between altitude and Pressure (1), altitude profile is derived using pressure sensor data. Pressure profile and altitude profile, measured during one of the instrumented parachute trials, for steady load condition is shown in Fig. 1 and Fig. 2 respectively.

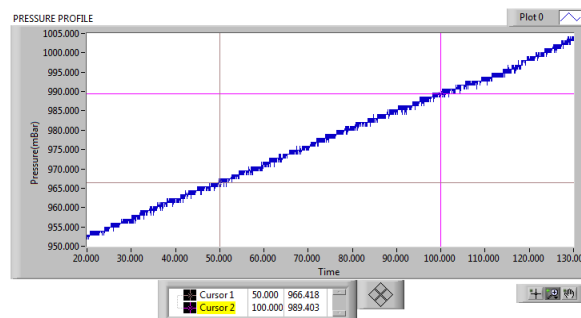

Figure 1 Pressure Profile in steady state region

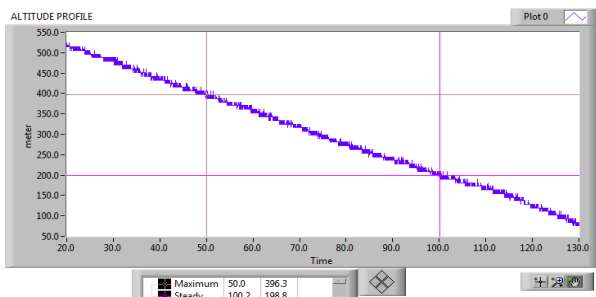

Figure 2 Altitude Profile in steady state

As evident from the figures, altitude variation is quite linear in steady state region and hence, it is used for rate of descent calculation. Rate of descent is calculated by calculating the slope of the altitude variation in steady state condition (Fig.2). Since accuracy of timing information is of paramount importance, microprocessor based data acquisition system was used.

### B. GPS based

Global positioning system (GPS) can also be used for altitude/velocity measurement of aerodynamic decelerators [2]. But for performance evaluation trials of aerodynamic decelerators, GPS based altimeter measurement face Time-to-First Fix problem as flight trial duration is very short (less than a minute). As GPS may take longer time for getting first fix, this method is not appropriate for trials lasting less than a minute.

### C. Accelerometer

Acceleration is defined as a rate of change of velocity and velocity can be calculated by integrating acceleration data. Hence this method uses tri-axial accelerometer for deriving velocity. Accelerometer is mounted so that its sensing axis is perpendicular to the platform (vertically downward) as shown in Fig.3. Acceleration is sensed by the sensing element of the accelerometer and corresponding voltage signal is generated. Data from accelerometer is recorded and integrated to achieve the velocity profile.

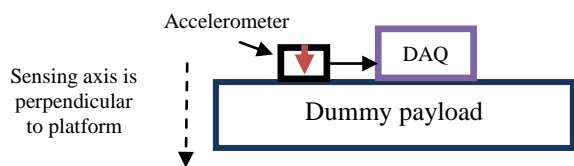

Figure 3 Accelerometer based velocity measurement setup

Limitations with this approach are that errors involved during integration are propagated and may result in erroneous velocity measurement. Also, if platform/ payload are oscillating, velocity derived from accelerometer data will not be accurate.

### D. Radar/Laser Altimeters

Radar/Laser is also being used for altitude measurement [3], [4], [5]. Radar altimeter mounted on decelerators, radiates the pulse towards the ground at time  $t_0$ . Transmitted pulse is

abstracted by the ground and a part of it being reflected towards the radar altimeter as indicated in Fig. 4. This reflected pulse is received at a time  $t_1$ . During this time interval  $(t_1-t_0)$ , decelerators has travelled a distance  $dH$ . By using this information, velocity can be measured by equation (2)

$$\text{Velocity} = dH / (t_1 - t_0) \quad (2)$$

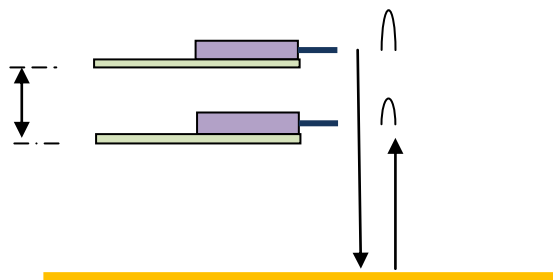

Figure 4 Velocity measurement using radar /laser altimeter.

Various Radar Altimeters are available for measurement of velocity based on above techniques, but in order to use them for aerodynamic decelerators mounting of radar altimeters could be a problem because of different shape and size of aerodynamic decelerator platforms and high probability of damaging the measurement setup. As the decelerators may oscillate in the flight trials, it may happen that transmitted pulse hit the ground at angles other than right angles. In such cases when platform is at some inclination, measured velocity value is greater than actual descent velocity.

### E. Plumb line with Video

Plumb line method is used for measuring the rate of descent measurement. This is a non-instrumented method for terminal velocity measurement. In this method, a mass is suspended by a string of known length (Plumb line). As shown in Fig. 5, other end is connected to the bottom of the dummy payload. During descent of parachute system, plumb line is suspended with the dummy payload. Timing event is recorded when suspended mass with plumb line touches the ground (say  $T_1$ ). Similarly, timing event when dummy payload touches the ground, as shown in Fig. 6, is recorded (say  $T_2$ ). These timings are captured using a video camera. Distance travelled by the dummy payload between the two events is equal to the length of plumb line.

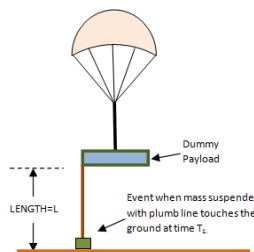

Figure 5: Event of suspended mass touching the ground

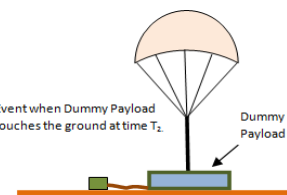

Figure 6: Event of dummy payload touching the ground

$$\text{TERMINAL VELOCITY} = \frac{\text{Length of Plumb Line}}{(T_2 - T_1)} \quad (3)$$

**Limitation:** If there is any visibility problem (during foggy condition) identification of  $T_1$  and  $T_2$  is very difficult.

### III. Proposed Method

#### A. Concept

As discussed earlier, plumb line methods used for terminal velocity measurement is having erroneous timing information (when plumb line weight touches the ground and payload touches the ground) because of its obvious limitations. In order to solve this problem, instrumented plumb line method is proposed for exact timing measurement and hence for terminal velocity. In this scheme, a mass of known weight is suspended with a string with adequate breaking strength to hold the suspended mass with the dummy payload. Suspended mass will produce the tension in the string of plumb line. This tension is measured & recorded during performance evaluation trial of parachute system using load link and microcontroller based Data Acquisition system (Fig. 7, 8 & 9).

Theoretically this load is constant and equal to the weight of the mass suspended with plumb line until it touches the ground (Figure 10.) As soon as plumb line mass touches the ground, load is released and this signature is recorded from the load link data. The time when this event occurred ( $T_1$ ) can be obtained from load link profile (drop of load from constant load to almost zero load) (Fig. 11).

Dummy payload further comes down and reaches the ground. When it touches the ground (Fig. 12), an impact is experienced by the platform. This signature is captured by an accelerometer mounted on the dummy payload. Hence, acceleration profile is used for obtaining  $T_2$ . Dummy payload travels the distance equal to the length of the plumb line during the time interval ( $T_2 - T_1$ ). So the terminal velocity is calculated using equation (3)

#### B. Measurement Setup

Implementation of this scheme uses following items:

- a. Load Links
- b. Accelerometer
- c. Data Acquisition system

Load applied due to mass of 2 kg suspended with plumb line is sensed by the strain gauge pasted on the 20 mm X 8 mm metallic strip. Output of the strain gauge is amplified and conditioned by signal conditioner and recorded using BL2120 Single Board Computer Based Data Acquisition System. Signal Conditioner was designed using Analog Devices AD1B31WB signal conditioner IC. Accelerometer data is also recorded for sensing the event of touchdown of dummy payload.

#### C. Sequence of operation

- i. Plumb line in winded with the Dummy Payload
- ii. Plumb line in suspended state
- iii. Plumb line touches the ground
- iv. Dummy platform touches the ground

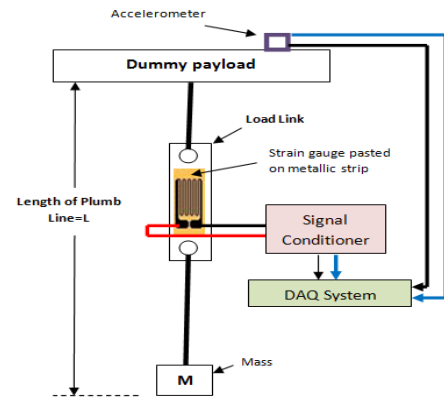

Figure 7: Instrumented Plumb line with accelerometer and data acquisition system

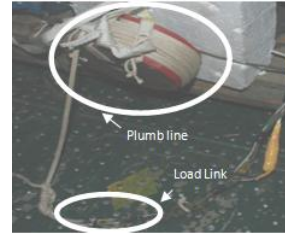

Figure 8: Load Link & Plumb line in trial setup



Figure 9: Load Link

Plumb Line is fastened with the dummy payload with the cordage and connected to weak tie which is connected to the riser (Fig 8). As soon as load on riser goes beyond the strength of the weak tie, it releases the plumb line.

Time ( $T_1$ ) at which mass touches the ground is identified by the load link data profile. Time ( $T_2$ ) is identified by using accelerometer data. Using timing information and length of plumb line, terminal velocity is calculated using equation (3).

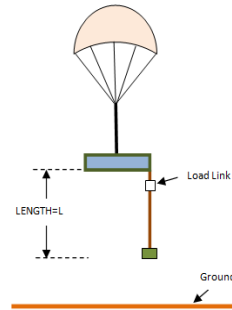

Figure 10: Load Link with mass in suspended state

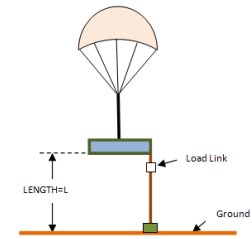

Figure 11: Load Link with mass touching ground ( $T_1$ )

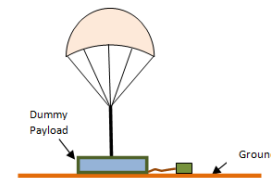

Figure 12: Payload touched ground ( $T_2$ )

## iv. Test Results

In order to validate the above scheme, it was used in one of the performance evaluation trial of parachute. To cross check the result, two other methods were used to measure terminal velocity using following methods.

- Pressure based method.
- Videography based method.

### A. Load Link Data Profile

Fig. 13 shows the load profile (a portion of it) measured using load link attached to plumb line. It is clear from the profile that at 125.802 second, measured load reduces to near zero, which is an indication of touching the mass with the ground.

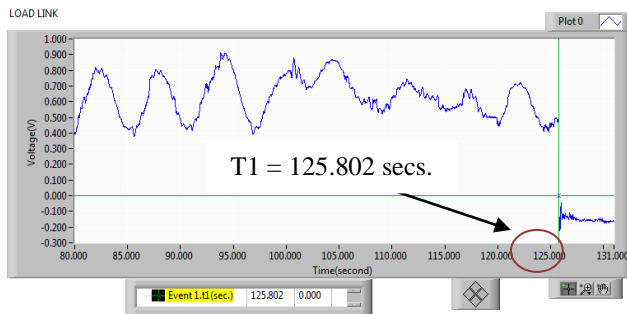

Figure 13: Load link data profile

### B. Acceleration Profile

Event of impact of dummy payload to the ground can be identified from the acceleration profile as shown in Fig. 14.

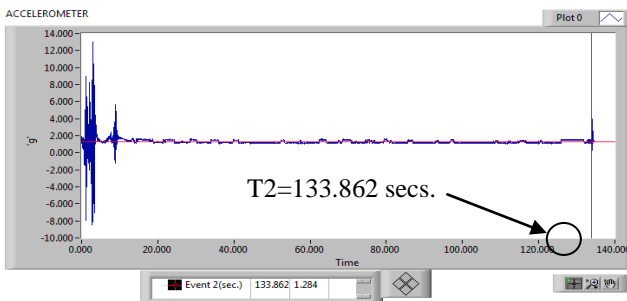

Figure 14: Acceleration data profile

### C. Measurement of Terminal Velocity

Length of plumb line used in this instrumented trial is 30.5 meter.

$$\text{Therefore, Terminal velocity} = L / (T_2 - T_1) \quad (4)$$

$$= 30.5 / (133.862 - 125.802)$$

$$\text{Terminal velocity} = 3.784 \text{ m/s}$$

In this instrumented test, terminal velocity is also measured using the pressure sensor based method. Altitude profile derived out of the pressure profile is indicated in Fig. 15. As can be observed, terminal velocity is 3.809 m/s.

This method is also verified by conventional terminal velocity measurement technique using videography technique. The results were found to be in close proximity.

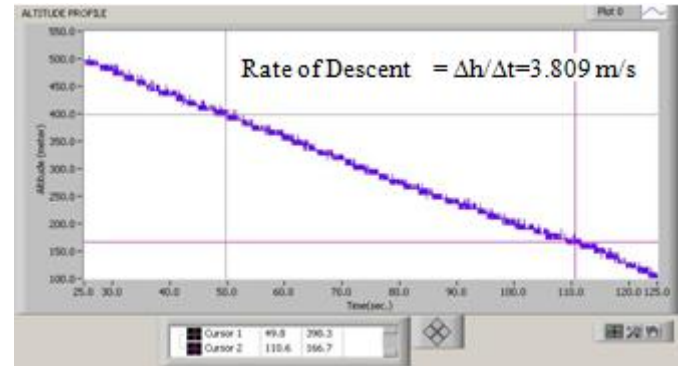

Figure 15: Altitude profile

## v. Conclusion

In this paper, measurement of terminal velocity parachutes based on instrumented plumb line is described. Verification of the method has been done in an instrumented test by comparing the results with conventional methods- pressure based, videography, etc. The results were found to be in close proximity.

### Acknowledgment

The authors would like to thank Dr. S C Sati, Director ADRDE for his unceasing guidance in successful completion of the task. The authors wish to acknowledge the assistance and support by VSSC team for providing the load link, and all others at ADRDE, Agra who have directly or indirectly contributed at various stages of development of the system.

### References

- [1] Chris Winkler and Jeff Baum: "Barometric Pressure Measurement Using Semiconductor Pressure Sensors", Freescale Application Note, AN1326
- [2] Joseph M. Strauss, Earl G. Blackwell, Christian A. Gellrich, Michael R. Kirkportrick, James W. Sinko: "Position, velocity and attitude instrumentation of a sport parachute jumper", ION GPS 200, Sep 2002
- [3] Michael L. Zähringer, Hannes S. Griebel: "A Height-Measuring Algorithm Applied to TERCOM Radar Altimeter", 2010 3<sup>rd</sup> International Conference on Advanced Computer Theory and Engineering.
- [4] Nadav Levanon: "IEEE transactions on Geoscience Electronics, Vol GE-8, No.1, Jan 1970.
- [5] R. Keith Raney: "The Delay/Doppler Radar Altimeter", IEEE transactions on Geoscience and remote sensing, Vol. 36, No. 5, Sep. 1998



About Authors:



Mahboob Ahmed completed his B.Tech (Electronics) from ZHCET, A.M.U., Aligarh. He is working in Aerial Delivery Research and Development Establishment (ADRDE) for last four years in the field of telemetry and data acquisition systems. He is also involved in development of microcontroller based systems design like Onboard Data logger etc.



Surendra M Jain received his B Tech degree from National Institute of Technology, Hamirpur, India in 2001 and M Tech degree in RF Design and Technology from Indian Institute of Technology, Delhi in 2010. Since 2001, he joined ADRDE (DRDO), Agra and currently he is Scientist-D. He has been working in the field of telemetry and instrumentation. He has also contributed towards development of various subsystems for projects related to parachute systems. His research interest includes wireless sensor networks and flexible antenna systems.



Deepak Kumar received his Diploma in Electronics and Telecommunication Engineering. from Sardar Ballabh Bhai Government Polytechnic Bhopal.. He joined ADRDE (DRDO), Agra in 1991 and currently he is Technical Officer 'B'. He has been working in the field of telemetry and instrumentation since last 18 years. He has also contributed towards development of various subsystems for projects related to parachute systems.



Alok Kumar Jain received Diploma in Electronics Engineering in 2001 from I.E.R.T Allahabad with Hons and A.M.I.E.T.E Degree in Electronics and Telecommunication from Institute of Electronics and telecommunication Engineers (IETE) New Delhi in 2009. He joined ADRDE (DRDO), Agra in 2005 and currently he is STA 'C'. He has been working in the field of telemetry and instrumentation since last 8 years for various development projects in ADRDE.