

# Modeling and Simulation DFIG Based on Wind Energy Conversion System in MATLAB/SIMULINK

S. Romphochai

Faculty of Engineering at Si Racha, Division of Electrical Engineering, Kasetsart University at Si Racha Campus, Chonburi, Thailand

P. Kumkratug

Faculty of Engineering at Si Racha, Division of Electrical Engineering, Kasetsart University at Si Racha Campus, Chonburi, Thailand

**Abstract**—This paper presents the model and simulation of Doubly Fed Induction Generator (DFIG) based on wind energy conversion system. It consists of wind turbine, drive train, DFIG and converter model. The DFIG and converter are in d-q model technique. The DFIG based on wind energy conversion system in MATLAB/SIMULINK is also introduced in this paper. The dynamic behaviours of DFIG with severe disturbance based on controller system are investigated in this paper.

**Keywords**— Wind Energy Conversion System, DFIG

## I. Introduction

At the present time, power generations use the fossil fuel, which emits the carbon dioxide to the atmosphere. Thus it highly affects on the environment [1]. In many countries, campaign is rapidly grown to use the energy that kind of clean energy. Renewable energy such as solar energy, ocean energy, and wind energy are proposed to release the use of fossil fuels [2]-[6].

Wind energy is a kind of clean energy. It is considered as one of the most challenge research areas. Wind energy system consists of wind turbine, drive train, and generator. Wind turbine converts the kinetic energy to the mechanical power which is coupled to the generator's shaft [7]. There are various kinds of generator applied in wind energy system such as Permanent Magnet Synchronous Generator (PMSG), induction generator and Doubly Fed Induction Generator (DFIG) [8]-[9]. DFIG is one of the most acceptable generators because of more flexible. Moreover, with the less rating of converter, it causes in lightweight mechanism structure and cost [10]-[12]. The largest size of DFIG is equipped in North America [13].

Modelling and simulation of wind energy system play very important role to study wind turbine, drive train, DFIG and converter dynamic. It helps us to investigate the characteristic, design and improve the converter controller before installation for maximum performance [14].

This paper presents wind turbine, drive train, DFIG and converter model connected to a grid. The presented method for wind energy system dynamic analysis is implemented in MATLAB/SIMULINK. The study of the dynamic behaviour when a three phase to ground fault occurrence in system was considered in this paper.

## II. Mathematical Models

This Section will provide the mathematical model of DFIG wind energy system. The configuration of DFIG based on wind energy conversion system is shown in Fig. 1.

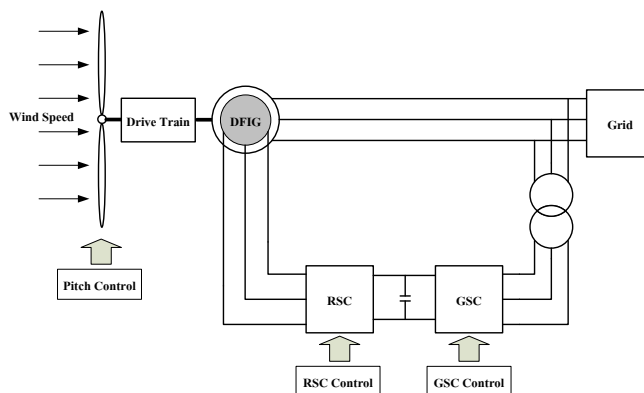

Figure 1. DFIG based on wind energy conversion system.

### A. Wind Turbine and Drive Train System

In steady state, the mechanical power which is extracted from the wind turbine.

Mechanical power  $P_m$  of wind turbine can be expressed by

$$P_m = c_p(\lambda, \beta) \frac{\rho A}{2} v^3 \quad (1)$$

$$c_p(\lambda, \beta) = c_1 \left( \frac{c_2}{\lambda_1} - c_3 \beta - c_4 \right) e^{-c_5 / \lambda_1} + c_6 \lambda \quad (2)$$

$$\frac{1}{\lambda_1} = \frac{1}{\lambda + c_7 \beta} - \frac{c_8}{\beta^3 + 1} \quad (3)$$

$$\lambda = \frac{R\omega}{v} \quad (4)$$

Mechanical torque  $T_m$  is the ratio of mechanical power to turbine speed as given by

$$T_m = \frac{P_m}{\omega} \quad (5)$$

Where  $c_p(\lambda, \beta)$ ,  $A$ ,  $v$ ,  $\beta$  are power coefficient, sweep area, wind speed and pitch angle, respectively.

The power from the wind turbine can be controlled via the power coefficient. In practical, it should be controlled by adjust the pitch angle to maintain a power from wind turbine. Fig. 2 shows the characteristic of wind turbine. For example at pitch angle  $\beta = 0^\circ$  the maximum power coefficient is around 0.48 and tip speed ratio is around 8.1.

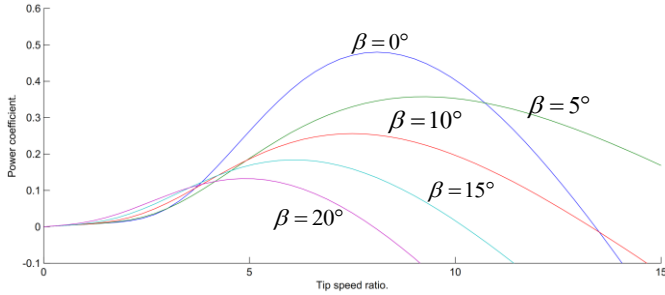

Figure 2. Wind turbine characteristic.

The drive train system consists of shaft, gearbox. Furthermore the dynamic analysis of wind turbine comprises with the damping factor. The two-mass model of the drive train system is described by [15]

$$2H_t \frac{d\omega_t}{dt} = T_m + T_t \quad (6)$$

$$2H_g \frac{d\omega_g}{dt} = T_e - T_t - F\omega_g \quad (7)$$

$$T_t = -[D_e(\omega_t - \omega_g) + K_e\theta_t] \quad (8)$$

$$\frac{d\theta_t}{dt} = \omega_t - \omega_b \quad (9)$$

$$\frac{d\theta_g}{dt} = \omega_g - \omega_b \quad (10)$$

Where  $H_t$  and  $H_g$  are turbine and generator inertia constant (s).  $\omega_t$ ,  $\omega_g$  are turbine and generator speed (p.u.).  $K_e$ ,  $F$  and  $D_e$  are angle stiffness, DFIG damping, equivalent damping coefficient, respectively.

## B. Doubly Fed Induction Generator (DFIG) Model

Doubly Fed Induction Generator (DFIG) is a wound rotor induction machine which is included stator and rotor winding. [16]. This paper uses d-q 5<sup>th</sup> order of DFIG [17].

The d-q stator voltage ( $u_{ds}$ ,  $u_{qs}$ ) are described by

$$u_{ds} = R_s i_{ds} + \frac{d\phi_{ds}}{\omega_b dt} - \omega_s \phi_{qs} \quad (11)$$

$$u_{qs} = R_s i_{qs} + \frac{d\phi_{qs}}{\omega_b dt} + \omega_s \phi_{ds} \quad (12)$$

The d-q rotor voltage ( $u_{dr}$ ,  $u_{qr}$ ) are written by

$$u_{dr} = R_r i_{dr} + \frac{d\phi_{dr}}{\omega_b dt} - (\omega_s - \omega_r) \phi_{qr} \quad (13)$$

$$u_{qr} = R_r i_{qr} + \frac{d\phi_{qr}}{\omega_b dt} + (\omega_s - \omega_r) \phi_{dr} \quad (14)$$

Where  $i_{ds}$ ,  $i_{qs}$  are direct and quadrature axis stator current.  $R_s$ ,  $R_r$  are stator and rotor resistance.  $\omega_s$ ,  $\omega_r$  are synchronous and DFIG speed.

The d-q stator flux ( $\phi_{ds}$ ,  $\phi_{qs}$ ) include self and mutual flux linkage are written by

$$\phi_{ds} = L_s i_{ds} + L_m i_{dr} \quad (15)$$

$$\phi_{qs} = L_s i_{qs} + L_m i_{qr} \quad (16)$$

The d-q rotor flux ( $\phi_{dr}$ ,  $\phi_{qr}$ ) include self and mutual flux linkage are expressed as

$$\phi_{dr} = L_r i_{dr} + L_m i_{ds} \quad (17)$$

$$\phi_{qr} = L_r i_{qr} + L_m i_{qs} \quad (18)$$

Where  $L_s$ ,  $L_r$  and  $L_m$  are stator, rotor and mutual inductance, respectively.

The electromagnetic torque  $T_e$  is expressed as

$$T_e = (\phi_{ds} i_{qr} - \phi_{qs} i_{dr}) \quad (19)$$

## C. Converter Model

DFIG converter system is a back-to-back VSC converter connected via a dc link capacitor. It consists of Rotor Side Converter (RSC) and Grid Side Converter (GSC). The RSC is controlled voltage source as it injects an ac voltage at slip frequency to the rotor. The GSC is controlled voltage source as generates an ac voltage. It maintains the dc link voltage to be constant value. The converter is expressed as [18]

$$P_r = P_g + P_{dc} \quad (20)$$

Where  $P_r$ ,  $P_g$ ,  $P_{dc}$  are RSC, GSC and dc link real power, expressed by following

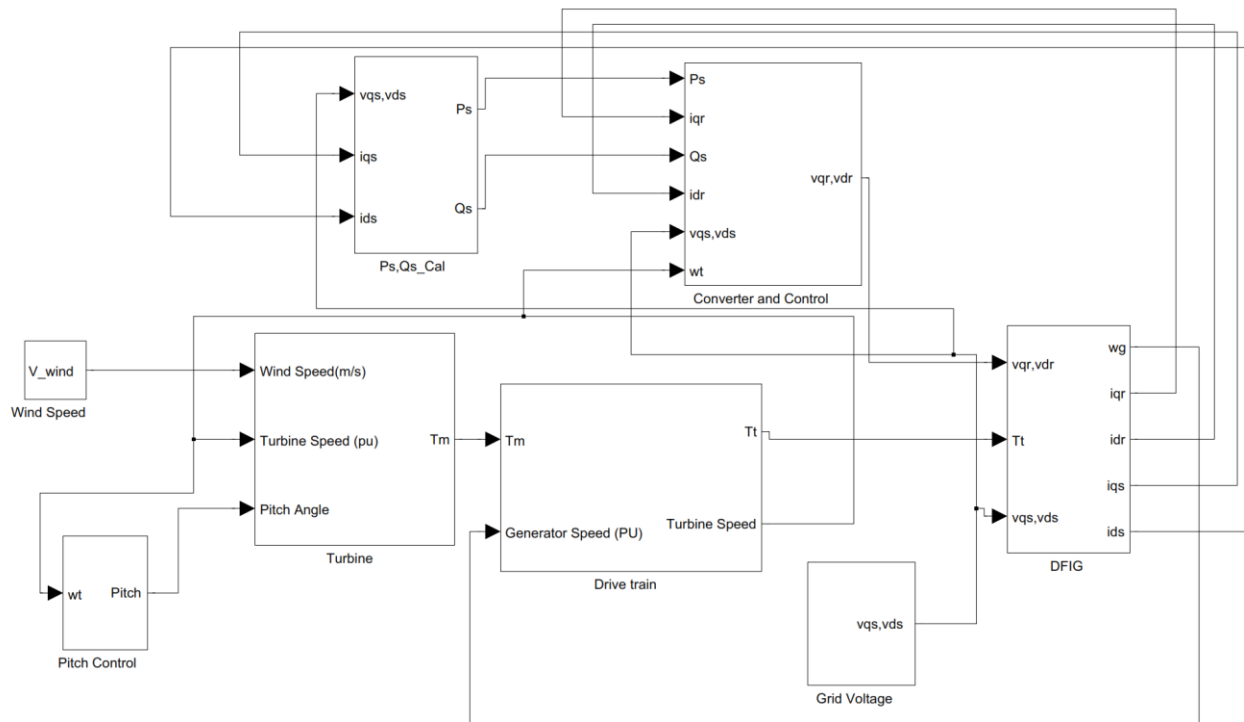

Figure 3. DFIG based on wind energy conversion system in MATLAB/SIMULINK.

$$P_r = v_{dr} i_{dr} + v_{qr} i_{qr} \quad (21)$$

$$P_g = v_{dg} i_{dg} + v_{qg} i_{qg} \quad (22)$$

$$P_{dc} = v_{dc} i_{dc} = C v_{dc\_nom} \frac{dv_{dc}}{dt} \quad (23)$$

## iv. Results

The wind energy system from Fig. 4 connects to grid via the transformers and transmission line. The DFIG rating is 2 MW at 0.95 lagging power factor. A temporary three-phase to ground fault occurs at point F. The fault is cleared after 0.2 second.

The dynamic behaviors of DFIG wind energy system are plotted. The rotor speed of DFIG is shown in Fig. 5. The dc link voltage is changed with severe disturbance because of the distinction of rotor and grid real power as shown in Fig. 6. Real and reactive powers are demonstrated in Fig. 7 and Fig. 8, respectively.

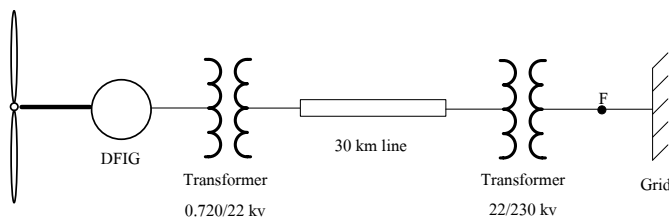

Figure 4. DFIG based on wind energy conversion system connected to grid.

## iii. MATLAB SIMULINK Models

The presented model of the DFIG based on wind energy conversion system is implemented in the MATLAB/SIMULINK as shown in Fig. 3. Fig. 3 shows the modules of DFIG wind energy system comprising wind turbine, drive train, DFIG, converter and controller. The turbine module is to calculate the output mechanical torque by (1)-(5). The (6)-(9) are applied in drive train module to calculate the shaft torque and turbine speed which are fed to DFIG and turbine module, respectively. DFIG module uses (7), (10) and (11)-(19) which are simulated its dynamic behavior. The module of converter is computed by using (20)-(23).

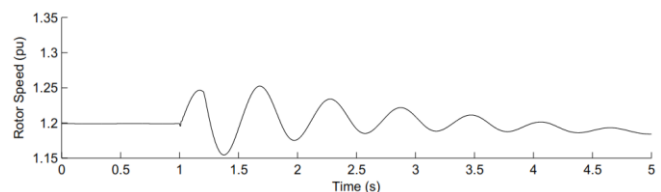

Figure 5. DFIG rotor speed (p.u.).

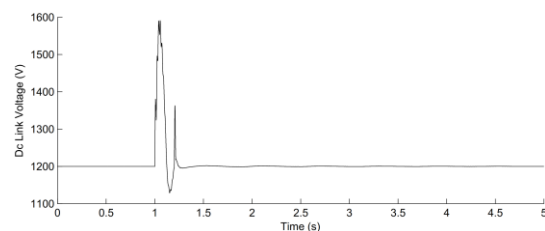

Figure 6. Dc link voltage.

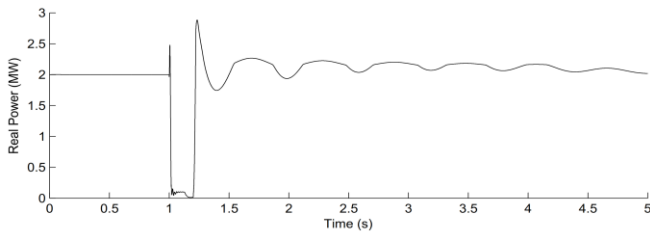

Figure 7. DFIG real power (MW).

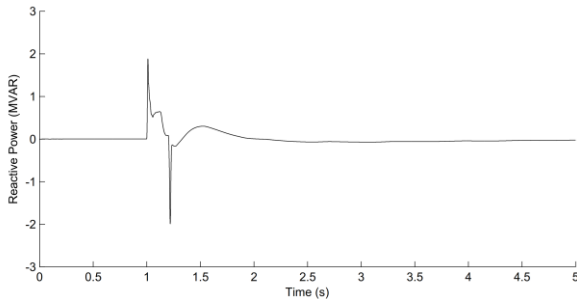

Figure 8. DFIG reactive power (MVAR).

## v. Conclusions

This paper has presented modeling and simulation of DFIG based on wind energy conversion system such as wind turbine, drive train, DFIG and converter. The presented model of DFIG and converter are in d-q references frame. Simulation of the DFIG based on wind energy conversion system has implemented in MATLAB/SIMULINK. The results have been shown the dynamic behaviors with severe disturbance. It helps us to comprehend the dynamic behavior of DFIG.

## Appendix

DFIG Data :

$$P = 2.0 \text{ MW}, f = 60 \text{ Hz}, R_s = 0.02 \text{ p.u.}, L_s = 0.15 \text{ p.u.}, \\ R_r = 0.018 \text{ p.u.}, L_r = 0.15 \text{ p.u.}, L_m = 3.2 \text{ p.u.}, H_g = 0.8 \text{ s}, \\ F = 0.1 \text{ p.u.}$$

Converter data :

$$V_{dc\_nom} = 1,200 \text{ Vdc}, C_{dc} = 0.15 \text{ F}$$

Turbine and Drive train data :

$$P_{nom} = 2 \text{ MW}, H_t = 5 \text{ s}, K_e = 1.3 \text{ p.u.}, D_e = 1.5 \text{ p.u.}, \\ C_1 = 0.5176, C_2 = 116, C_3 = 0.4, C_4 = 5, C_5 = 21, \\ C_6 = 0.0068, C_7 = 0.08, C_8 = 0.035$$

Transmission line data :

$$R_l = 0.115 \text{ } \Omega/\text{km}, L_l = 0.001 \text{ H/km}$$

## References

[1] H. Xu, J. Hu, and Y. He, "Operation of Wind-Turbine-Driven DFIG Systems Under Distorted Grid Voltage Conditions : Analysis and Experimental Validations," *IEEE Trans. Power Electronics*, vol. 27, no. 5, pp. 2354-2366, May. 2012.

[2] Y. Zhang, A. A. Chowdhury, and D. O. Koval, "Probabilistic Wind Energy Modeling in Electric Generation System Reliability Assessment," *IEEE Trans. Industry Applications*, vol. 47, no. 3, pp. 1507-1514, May/June. 2011.

[3] L. Trilla, O. G. Bellmunt, A. J. Ferre, M. Mata, J. S. Navarro, and A. S. Andreu, "Modeling and Validation of DFIG 3-MW Wind Turbine Using Field Test Data of Balanced and Unbalanced Voltage sags," *IEEE Trans. Sustainable Energy*, vol. 2, no. 4, pp. 509-519, Oct. 2011.

[4] L. M. Fernandez, F. Jurado, J. R. Saenz, "Aggregated Dynamic Model for Wind Farms with Doubly Fed Induction Generator Wind Turbines," *Renewable Energy An International Journal*, vol. 33, pp. 129-140, Mar. 2007.

[5] J. Prudell, M. Stoddard, E. Amon, T. K. A. Brekken, and A. V. Jouanne, "A Permanent-Magnet Tubular Linear Generator for Ocean Wave Energy Conversion," *IEEE Trans. Industry Applications*, vol. 46, no. 6, pp. 2392-2400, Nov/Dec. 2010.

[6] M. Rizwan, M. Jamil and D. P. Kothari, "Generalized Neural Network Approach for Global Solar Energy Estimation in India," *IEEE Trans. Sustainable Energy*, vol. 3, no. 3, pp. 576-584, Jul. 2012.

[7] A. Luna, F. K. A. Lima, D. Santos, P. Rodriguez, E. H. Watanabe, and S. Arnaltes, "Simplified Modeling of a DFIG for Transient Studies in Wind Power Applications," *IEEE Trans. Industrial Electronics*, vol. 58, no. 1, pp. 9-20, Jan. 2011.

[8] A. Uehara, A. Pratap, T. Goya, T. Senjyu, A. Yona, N. Urasaki and T. Funabashi, "A Coordinated Control Method to Smooth Wind Power Fluctuations of a PMSG-Based WECS," *IEEE Trans. Energy Conversion*, vol. 26, no. 2, pp. 550-558, Jun. 2011.

[9] E. S. Abidin, W. Xu, "Control Design and Dynamic Performance Analysis of a Wind Turbine-Induction Generator Unit," *IEEE Trans. Energy Conversion*, vol. 15, no. 1, pp. 91-96, Mar. 2000.

[10] X. Yan, G. Venkataramanan, P. S. Flannery, Y. Wang, Q. Dong, and B. Zhang, "Voltage-Sag Tolerance of DFIG Wind Turbine With a Series Grid Side Passive-Impedance Network," *IEEE Trans Energy Conversion*, vol. 25, no. 4, pp.1048-1056, Dec. 2010.

[11] E. Rezaei, A. Tabesh, and M. Ebrahimi, "Dynamic Model and Control of DFIG Wind Energy Systems Based on Power Transfer Matrix," *IEEE Trans. Power Delivery*, vol. 27, no. 3, pp.1485-1493, Jul. 2012.

[12] H. Xu, J. Hu, and Y. He, "Integrated Modeling and Enhanced Control of DFIG Under Unbalanced and Distorted Grid Voltage Conditions," *IEEE Trans. Energy Conversion*, vol. 27, no. 3, pp.1485-1493, Sep. 2012.

[13] S. Li, T. A. Haskew, K. A. William and R. P. Swatloski, "Control of DFIG Wind Turbine With Direct-Current Vector Control Configuration," *IEEE Trans. Sustainable Energy*, vol. 3, no. 1, pp. 1-11, Jan. 2012.

[14] M. Ghofrani, A. Arabili, and M. Etezadi-Amoli, "Modeling and Simulation of a DFIG-Based Wind-Power System for Stability Analysis," *IEEE Power and Energy Society General Meeting*, pp. 1-8, Jul. 2012.

[15] H. Li, B. Zhao, C. Wang, H. W. Chen. and Z. Chen, "Analysis and Estimation of Transient Stability for a Grid-Connected Wind Turbine," *Renewable Energy An International Journal.*, vol. 36, pp. 1469-1476, Aug. 2010.

[16] F. Hachicha and L. Krichen, "Rotor Power Control in Doubly Fed Induction Generator Wind Turbine under Grid Faults," *Energy An International Journal.*, vol. 44, pp. 853-861, May. 2012.

[17] L. Yang, Z. Xu, J. Østergaard, Z. Y. Dong and K. P. Wong, "Advanced Control Strategy of DFIG Wind Turbines for Power System Fault Ride Through," *IEEE Trans. Power Systems*, vol. 27, no. 2, pp. 713-722, May. 2012.

[18] Y. Mishra., S. Mishra, M. Tripathy, N. Senroy and Z. Y. Dong, "Improving Stability of a DFIG-Based Wind Power System With Tuned Damping Controller," *IEEE Trans. Energy Conversion.*, vol. 24, no. 3, pp. 650-660, Sep. 2009.