

Concept of Turbojet Engine for Automobiles

Mukul Anand
Mechanical Engineering
Sikkim Manipal Institute of Technology
Majhitar, India

Pragyan Kumar Sarma
Mechanical Engineering
Sikkim Manipal Institute of Technology
Majhitar, India

T.Y. Ladakhi
Asst. Professor Mechanical Engineering
Sikkim Manipal Institute of Technology
Majhitar, India

S. Sharma
Asst. Professor Mechanical Engineering
Sikkim Manipal Institute of Technology
Majhitar, India

Abstract— In this research paper an attempt has been made to *design and analyze a small turbojet engine using scrap automobile parts, turbocharger being the major component. The engine has been designed and analyzed in Sikkim Manipal Institute of Technology using used turbochargers that can be used in modern automobile. In this design the thrust generated from the turbine section of a turbo charger is used to drive the power turbine generating the shaft power and also an attempt has been made to convert the turbo jet into turbo prop jet so as to increase its efficiency.*

Keywords— *Turbojet Engine , Turbocharger, Turboprop Jet, Gas turbine*

I. Introduction

Gas turbine cycles for jet propulsion differ from shaft power cycle because of the fact that the useful power output for jet propulsion is produced, wholly or partially, as a result of expansion of gas in propelling nozzle; wholly in Turbojet engines and partially in Turboprop engines. The beneficial effect of parameter like working temperature range , together with an inherently high power/weight ratio have enabled gas turbine to replace reciprocating engine for aircraft propulsion. With rising demand of automobile and scarce fossil fuels, emphasis is on now better design or alternative fuel. Perhaps designing a gas turbine engine could lead to solution where it provides a wide option of fuel, basically any combustible fuel like petroleum distillate, hydrogen, natural gas and even coke dust.

II. Design Specification

When defining the specifications for turbojet engine, we thought about a compact, lightweight, low cost and easy to fabricate system that would satisfy the need of modern automobile, a choice that we identified as reasonable for an effective research without excessive expenditure and that can be looked upon as long run with further future scope. These

features were achieved according to basic thermodynamic and mechanical rules, described as below.

- The working cycle of the design to be a simple open Brayton thermodynamic cycle to avoid any sophistication , such as regeneration, intercooling, bleeding.
- To limit the turbine inlet temperature little lower than the maximum allowable temperature of turbine blades even at the cost of efficiency lower than the maximum possible efficiency.
- Use standard technology turbo machinery available without variation in it.
- Use of exhaust nozzle convergent in shape that can provide mass flow enough to utilize the optimum of the power turbine.

III. Design Procedure

The following are the steps we used in designing of the engine. Finally, complete content and organizational editing before formatting. Please take note of the following items when proofreading spelling and grammar:

A. Compressor, Turbine and Power Turbine Section

As we intend a low cost engine and parts to be easily available centrifugal compressor was the optimum choice as they are in turbochargers. A centrifugal compressor is one of it's class of machines in producing pressure rise and is known as turbo compressor. In this type energy is transferred by dynamic means from a rotating member to the continuously flowing working fluid. The main feature of the centrifugal compressor is that, the angular momentum of the fluid flowing through the impeller is increased partly by the virtue of the impeller's outlet diameter being significantly larger than its inlet diameter. Although the pressure ratio here is 4:1 , lower than the axial flow type that are used in turbojet engine of

aircraft where pressure ratio is very high, it possess certain advantages for this application. They are:

- It occupies a smaller length than the equivalent axial flow compressor.
- It is not so liable to loss of performance by build up deposits on the surface of the air channels.
- It can work reasonably well in a contaminated atmosphere compared to axial flow type.
- It is able to operate efficiently over a wider range of mass flow rate at any particular rotational speed.
- It is suitable for the designed turbine whose inlet temperature is in the region of 1000 – 1200K

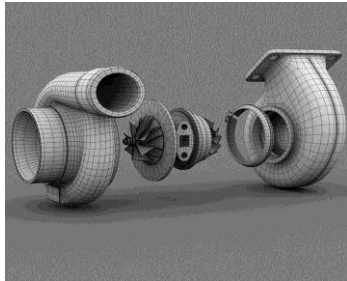

Fig1: Turbocharger assembly

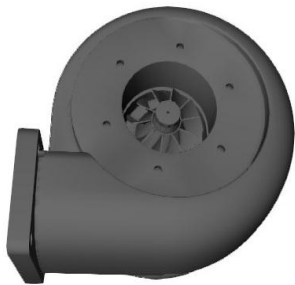

Fig2: Power Turbine Design

B. **Combustion Chamber**

The main function of a combustion chamber in such engine is to provide for the complete combustion of fuel and air, the air being supplied by the compressor and the products of combustion being delivered to turbine. To carry out these function, the combustion chamber must fulfill following:

- Complete combustion of fuel must be achieved as is directly reflected in the fuel consumption or thermal efficiency.
- Total pressure loss must be minimum.
- Carbon deposit must not be formed under any condition of operation as it will upset the design flow and increase pressure loss

- Temperature and velocity distribution at turbine inlet must be controlled.
- The volume and weight of the combustor must be kept within reasonable limit.
- The geometrical dimension of flame tube liner and air jacket should be maintained according to turbine inlet and blade diameter.

The process of combustion of a liquid involves the following :

- The mixing of fine spray of fuel droplets with air
- Vaporization of the droplets
- the breaking down of heavy hydrocarbon into lighter fractions
- the intimate mixing of molecules of hydrocarbon with oxygen to promote chemical reaction hence combustion.

The air in the flame tube is introduced in stages. The three stages being:

- About 15 – 20 per cent of total air is introduced around the jet of fuel in the primary zone to provide necessary high temperature for rapid combustion.
- Some 30 per cent of the total air is then introduced the holes in flame tube in the secondary zone to complete the combustion. For high combustion efficiency, this air must be injected carefully at right points in the process.
- In the tertiary or dilution zone the remaining air is mixed with the products of combustion to cool them down to the temperature required at inlet to the turbine.

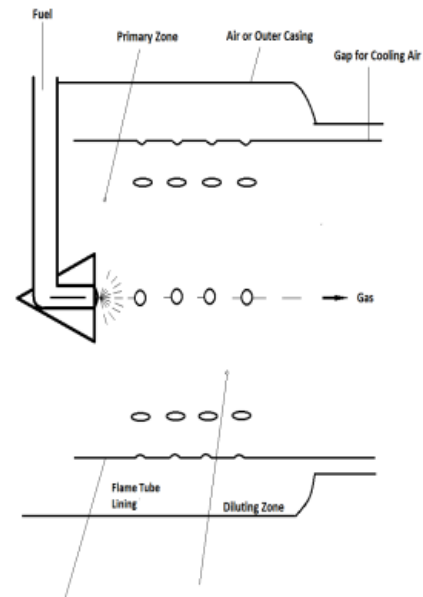

Fig3:Flow through chamber

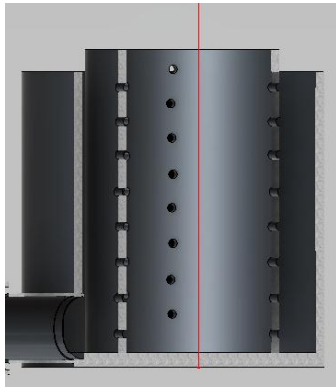

Fig4: Sectional view

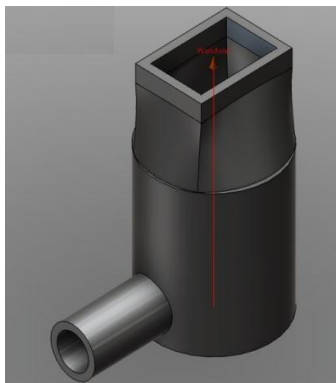

Fig5: combustion chamber

C. Nozzle

The purpose for the nozzle is to accelerate the exhaust gas to provide more thrust and direct it to power turbine in order to drive it.

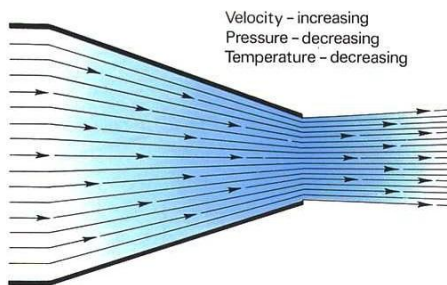

Fig6. Flow through nozzle

IV. Working of Engine

The working of our designed engine is simple compared to that of an IC reciprocating engine. Basically it involves the pulling in and compressing of air to the engine in relatively large quantities and then expanding this air and using it to drive a turbine. The turbine is connected by a common shaft to the compressor. About 10% of the power generated is used to turn the compressor. The compressor pulls air into the engine and compresses it. This air then enters a combustion chamber where fuel is added and ignited, resulting in the rapid

expansion of the gases, these are used to drive the turbine. The thrust generated is used to drive power turbine by passing the propelling air over it through a converging nozzle.

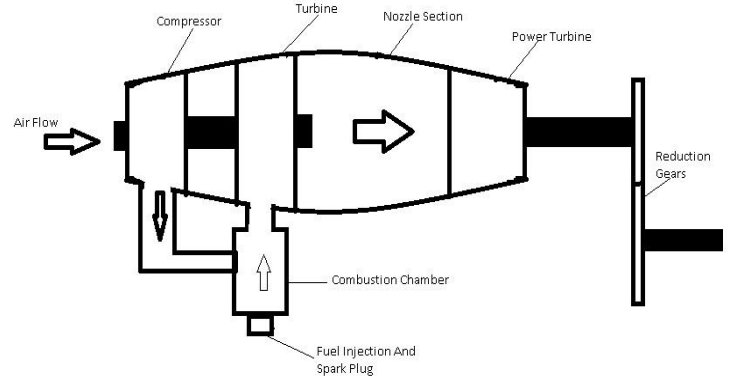

Fig 7. Layout of designed engine

v. Further Developments to Turboprop

Turboprop design differs from turbojet just cause of attachment of propeller in front of compressor. Higher thrust per unit mass flow can be obtained by increasing the mass flow of air which results in better fuel economy. This concept is utilized in turboprop. The propulsive thrust developed is due to:

- The propeller increase the air momentum.
- The overall engine provides an internal momentum increase.

The sum of these two is the total thrust.

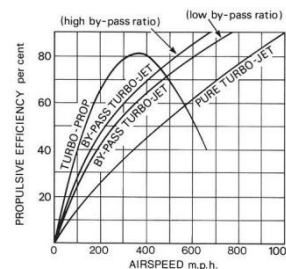

Fig 8: Propulsive efficiency comparisons between different turbojets

Turboprop engine has advantage of high thrust and good propeller efficiency over turbojet over the range of air speed lower than 400 Miles per hour. Its operational range is similar to the Turbojets and can operate in any speed up to 700 miles per hour. The major advantage of turboprop are:

- Have higher thrust and better fuel economy
- It is easy to maintain and has lower vibrations
- High efficiency

The implementation of turboprop technique in turbojet engine for an automobile can be used, but not similar to turboprop planes where a propeller is attached to compressor hub by means of reduction gear. Here more portion of power generated by turbine is used in driving compressor and propeller and very little is left to produce thrust in nozzle section. Here we are more concentrated on thrust generation at shaft end. So we use a motor power propeller in front of compressor opening serving two functions:

- Increasing the momentum of air entering the compressor.
- Acting as cooler for heat exchanger of cooling oil flow circuit. And in doing so it also preheat the air entering the combustion chamber thus increasing fuel economy and efficiency of the engine.

VI. Design Dimensions

Compressor Inducer Diameter	4.9 cm
Flame Tube Diameter	15 cm
Flame Tube Length	30 cm
Air jacket Diameter	18 cm
Primary zone hole Diameter	0.6 cm
Secondary zone hole Diameter	1 cm
Tertiary zone hole Diameter	1.6 cm
Number of Primary holes	21
Number of Secondary holes	6
Number of Tertiary holes	5

VII. Conclusions

This theoretical analysis and design of turbojet and turboprop model - for automobile based on study of airplane turbojet engine showed the concept of using new type engines generating more power with convenience of using various fuel in same engine rather than restricting to single type fuel use as in comparison to prevailing reciprocating engines. It also lead to solution where it provides a wide option of fuel like petroleum distillate, hydrogen, natural gas etc.

Acknowledgment

We are grateful to Dr. B. B. Pradhan (HOD Mechanical SMIT) for giving us a scope to accomplish our Major Project.

We would also like to thank our teacher guide Miss T.Y.Ladakhi Mr. Saurabh Sharma ,and specially our thermodynamic Teacher Professor P.S.Bandhopadyay for helping us to revive our engineering knowledge through valuable information and practical work, with were the impetus to give practical shape. We also thank our department teachers who have shared their valuable time with us in constantly guiding us through our entire project period and without whose co-operation our work would not have been accomplished.

We would like to thank Rolls Royce for providing “Rolls Royce - The Jet Engine 2nd Ed 1996” book free online which had help us a lot throughout the project.

The preparation of this report has helped us to recapitulate all that we have learnt during our project.

Last but not the least we would like to thank all those who have been directly or indirectly associated with us to our limited theoretical knowledge, throughout the entire training period and extending their helping hands towards us.

References

- [1] Tetsuya Sato, Hideyuki Taguchi, Hiroaki Kobayashi, Takayuki Kojima,Keiichi Okai, Kazuhisa Fujita, Daisaku Masaki, Motoyuki Hongo, Toyohiko Ohta (2007), Development study of precooled-cycle hypersonic turbojet engine for flight demonstration, Acta Astronautica 61 (2007) 367 – 375
- [2] N. Tanatsugu, T. Sato, Y. Naruo, et al., Development study on ATREX engine, Acta Astronautica 40 (1996) 165–170
- [3] Chu HH, Chiang Hsiao-Wei. Aerospace technology development – Small gas-turbine development. Taiwan,ROC: Aerospace Development Planning, National Science Council; 1996.. 4–22.
- [4] Jackson AJB, Laskaridis P, Pilidis P. Test bed for small aero gas-turbines for education and for University–Industry Collaboration. ASME Paper GT-2004-54334; 2004.
- [5] Hill PG, Peterson CR. Mechanics and thermodynamics of propulsion. Reading (MA): Addison-Wesley;1992.
- [6] The jet engine, Rolls-Royce plc 1986
- [7] V Ganeshan (2003,1999),Gas Turbines, Tata McGraw Hill Publishing Limited, New Delhi
- [8] Mukul Anand, Pragyan Sharma, T.Y.ladakhi, S.Sharma, Design and analysis of turbojet engine for automobile, International journal of engineering reserach and technology(2013),245-249