

Analysis of Drag Coefficient of Cannonballs Colliding into Water Surface

Y. K. Kim, H. S. Bang and W. C. Choi

Graduate School, Department of Mechanical Engineering
 Korea University
 Seoul, South Korea

H. S. Lee and S. H. Park

D.S.T.C 2nd Team
 Agency for Defense Development
 Tae-an, South Korea

Abstract—When a cannonball collides onto water, it can ricochet several times when a normal force generated larger is than sum of the weight and inertia force. The impact occurring during collision is influenced by the drag coefficient, lift coefficient, sea wave angle, cannonball speed, initial launch angle, etc. In order to determine the moving path of the cannonball, an analysis is done to calculate the position and velocity of the cannonball and the force acting on the cannonball using a finite element method. In this study, the drag and lift coefficients are calculated through experiment and energy equations. It is found that a high entry angle when collide into water surface results the high drag and lift coefficients, and that the ricocheting distance varies depending on the sea wave angle, launch angle and launch height.

Keywords—Ricochet, Cannonball, Impact, Impulse, Nose-cone, Collision, Haack-series, Shape constant, Lift coefficient, Drag

I. Introduction

When a cannonball fired at high speed and low launch angle collides with water, it can ricochet. The path of the cannonball was obtained numerically. However, drag and lift coefficient during collision occurring at very short time were not reported. The impulse force occurring during collision depends on initial speed, launch angle, initial height, wave tide angle, etc. it influences the drag and lift coefficients. Therefore, in this study, drag coefficients will be determined experimentally, and used in the analysis. The ricocheting condition will be presented for a weapon acceptance test and a safety evacuation zone can be set efficiently.

II. Theoretical Background

A. Data of K307

K307 cannonballs are fired with high spin rate caused by a spiral groove, to stabilize the orientation during flight.

Fig. 1 shows the K307 cannonball, and Table 1 shown the technical data of the cannonball.

B. Equation of motion during impact

When the fired cannonball collides with sea water, force is resulted: F_x in the horizontal direction and F_z in the vertical direction as shown in Fig. 2.



Figure 1. K307 cannonball

TABLE I. TECHNICAL DATA OF K307 CANNONBALL[1]

Property	K307
Weight	46.4 kg
Length	945 mm
Filler	TNT
Maximum range	41 km
Muzzle velocity	850 m/s

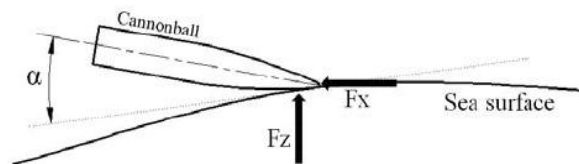

Figure 2. Forces during collision of a cannonball with sea water

Ricocheting occurs when the resulting force in the vertical direction is greater than the sum of the weight and the inertial force. This phenomenon is called bouncing or ricocheting. Eq. (1) shows the resulting force during collision. \hat{n} is a normal unit vector and \hat{t} is a tangential unit vector.

$$F = \frac{1}{2} C_l \rho_0 V^2 S_{im} \hat{n} + \frac{1}{2} C_f \rho_0 V^2 S_{im} \hat{t} \quad (1)$$

The governing equations are written as [2].

$$M \frac{dV_x}{dt} = -\frac{1}{2} \rho_0 V^2 S_x (C_l \sin \alpha + C_f \cos \alpha) \quad (2)$$

$$M \frac{dV_z}{dt} = -\frac{1}{2} \rho_0 V^2 S_z (C_f \cos \alpha + C_l \sin \alpha)$$

where C_l is a lift coefficient, C_f is a tangential friction coefficient, V is the speed of cannonball, α is an entry angle, and S_x and S_z are the areas of submerged part projected to X and Z axes, respectively.

The variables affecting the ricocheting of the cannonball are the lift and friction coefficients and the entry angle, as shown in Eq. (1).

C. Pierson-Moskowitz Spectrum

The shape of sea surface can be obtained by using the Pierson-Moskowitz Spectrum model. The model was obtained from 5 year data with 1000 sea wind data and 460 tide shapes, and can be written as Eq. (3).

$$F_{PM}(f) = \frac{\alpha g^2}{(2\pi)^4 \times f^5} e^{-\left[\frac{z}{f} \left(\frac{z}{f}\right)^4\right]} \quad (3)$$

where $F_{PM}(f)$ is a force related to spectrum of forward wind, f is frequency, f_m is a natural frequency, $\alpha = 0.0081$ (Phillips constant), $g = 9.81 \text{ m/s}^2$ [3].

Fig. 3 - 4 show tide shapes based on the Pierson-Moskowitz Spectrum theory. The wind speed is 10m/s, and the direction is northeasterly.

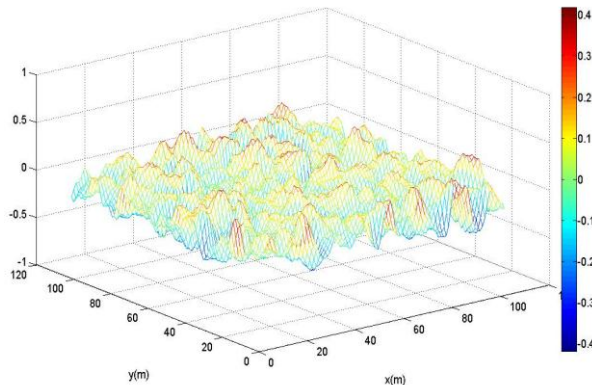

Figure 3. Tide shape for $V=10\text{m/s}$, $\theta=45^\circ$

D. Source panel method

The collision between a cannonball and sea surface is solid collision against fluid. During collision, the flow can be assumed to be non-viscous incompressible, and surface pressure and momentum can be obtained[4].

The governing equation for source panel method is written as Eq. (4), the boundary condition at body surface is Eq. (5) and the boundary condition at the effective water surface is Eq. (6).

$$\nabla^2 \phi = 0 \quad (4)$$

$$-\nabla \phi \cdot \mathbf{e}_n = V_e \cdot \mathbf{e}_n \quad (5)$$

$$\mathbf{r} \cdot \mathbf{V}_s = (C_w - 1) V_p \cdot \mathbf{k} = \frac{\partial \Phi}{\partial Z} (x, y, 0) \cdot \mathbf{k}$$

$$= \frac{\partial \Phi}{\partial Z} (x, y, 0) \cdot \mathbf{k} \quad (6)$$

$$\Phi = 0$$

where Φ is velocity potential, V_e^{LM} is the entry speed of the cannonball, \mathbf{e}_n^{LM} is a unit normal vector, V_s^{LM} is the speed of the effective surface, V_p^{LM} is the speed of the deepest cannonball.

Fig. 5 shows the K307 surface divided with elements[5]. The surface is divided into many elements and sources with certain strengths are distributed onto the centers. The velocity potential can be obtained with source strength, σ_j .

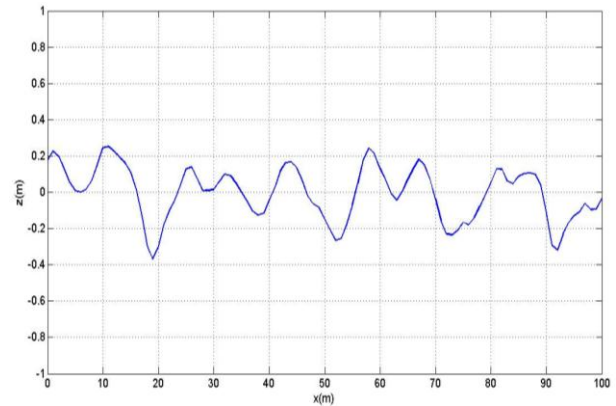

Figure 4. The tide cross-section for $V=10\text{m/s}$, $\theta=45^\circ$, $y=5\text{m}$

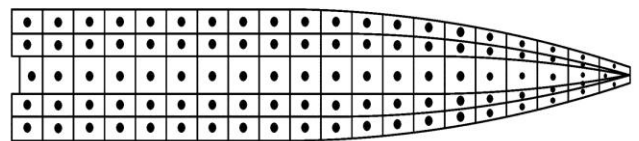

Figure 5. K307 cannonball divided into elements

Eq. (8) represents N simultaneous equations, by applying N elements to Eq. (7).

$$\Phi_j(x, y, z) = -\frac{1}{4} \int_A \frac{\sigma_j dA}{R} \quad (7)$$

$$R = \sqrt{(x-x_0)^2 + (y-y_0)^2 + (z-z_0)^2}$$

where dA is the surface area of the element, (x_0, y_0, z_0) is the coordinate of the centers, and (x, y, z) is the coordinate of Φ_j

$$\sum_{j=1}^N A_{ij} \sigma_j = [A_{ij}] \sigma_j = \left[\frac{\mathbf{r}}{V_e} \cdot \mathbf{e}_n \right] \quad (8)$$

where σ_j is the source strength at element j, $[A_{ij}]$ is an array of normal vectors induced from unit source strengths to element i, and $\frac{\mathbf{r}}{e_n}$ is a unit normal vector at element i.

Source strengths can be obtained by solving Eq. (8) and the velocity potential can be obtained.

$$\Phi = \sum_{j=1}^N B_{ij} \sigma_j = [B_{ij}] \sigma_j \quad (9)$$

where $[B_{ij}]$ is an array of velocity potential on element I by unit source strength of element j.

Surface pressure can be obtained by applying velocity potential to non-steady Bernoulli equation.

$$C_p = \frac{(p - p_\infty)}{\frac{1}{2} \rho_\infty V_\infty^2} = 1 - \frac{|\nabla\Phi|^2}{V_\infty^2} \quad (10)$$

$$= \frac{2}{V_\infty^2} \left[\frac{\partial\Phi}{\partial t} + \left(\frac{\mathbf{r}}{V_e} \cdot \nabla\Phi \right) - \frac{\nabla\Phi^2}{2} \right]$$

The vertical impulse force and impulse moment can be calculated.

III. Drag Coefficient Experimentation

In order to obtain drag coefficient during collision of a cannonball with water, experiment was conducted. A reduced model of a cannonball was made and used in the experiment.

The experimental setup is shown in Fig. 6. By adjusting the pressure applied to the model cannonball, the initial speed can be controlled, and the angle can be adjusted[6].

The drag coefficient obtained from the experiment was used to analysis of ricocheting.

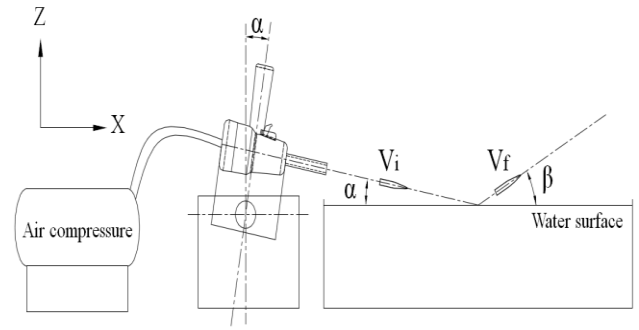

Figure 6. Experimental setup for cannonball model tests[6]

A. Experimental Method

The experiment is done by recording cannonball collision faster than 300fps. The model cannonball is discharged in a water tank at a certain angle and speed. The motion of the model cannonball is recorded, and from the pictures before and after collision the entry angle and speed, and exit angle and speed are obtained.

The horizontal force and vertical force are calculated from Eq. (11). From Eq. (12), the lift and frictional coefficients can be obtained.

$$m(V_{xi} - V_{xf}) = F_{x_avg} g \Delta t \quad (11)$$

$$m(V_{zi} - V_{zf}) = F_{z_avg} g \Delta t$$

$$F_{x_avg} = \frac{1}{2} \rho_w S_x V^2 g C_f \quad (12)$$

$$F_{z_avg} = \frac{1}{2} \rho_w S_z V^2 g C_l$$

where C_f is the horizontal frictional coefficient, C_l is the vertical lift coefficient, ρ_w is the water density, S_x, S_z are the projected areas, v_i is the speed before collision, v_f is the speed after collision, F_{avg} and is the impulse force during collision.

IV. Analysis and Result

A. Result of K307 experiment

With various entry angles and speed, experiments were done. For different model cannonballs, experiments were also conducted.

The entry angle less than 10° is called low angle, the entry angle between 10° and 20° is called middle angle, and the entry angle greater than 20° is called high angle.

Fig. 7 shows reflection angle vs. entry angle. At low angle, the reflection angle was 2-2.5 times larger than the entry angle. At middle angle, the reflection angle was 0.7-1.8 times the entry angle. At high angle, the reflection angle is less than the entry angle and ricocheting did not occur for high initial speed.

For K307 cannonball, the horizontal and vertical coefficients were obtained and shown in Fig. 8 - 9. The horizontal coefficient increases with the entry angle. It was found to be 0.21 for 5° and 0.53 for 23°.

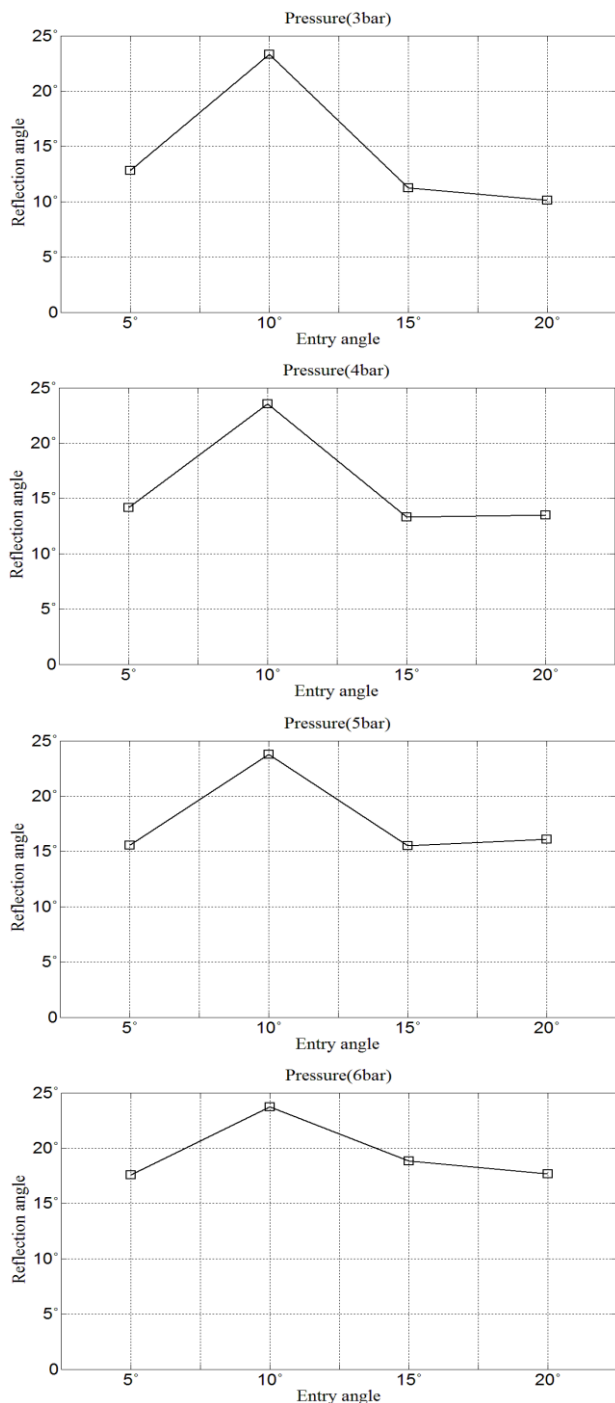

Figure 7. Entry angle and reflection angle about K307

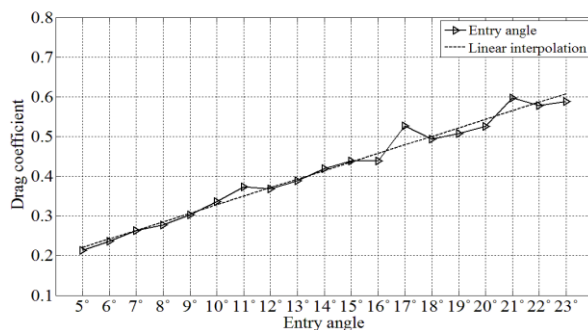

Figure 8. Drag coefficient values of K307

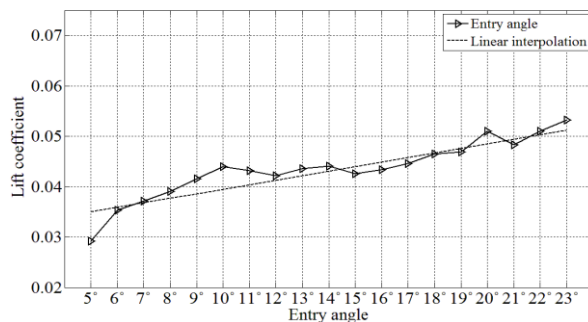

Figure 9. Lift coefficient values of K307

v. Conclusions

For K307 cannonball, the reflection angle is similar to the entry angle at 15°. For entry angle higher than 23°, ricocheting did not occur.

For K307 cannonball, as the entry angle increases, the horizontal and vertical coefficients increase.

Acknowledgment

This study is supported by Agency for Defense Development general basic study (ADD-10-01-06-14).

References

- [1] Poongsan, <http://www.poongsan.co.kr>
- [2] GLydéric B, "The physics of stone skipping," *Amrican Journal of Physics*, 71, Issue 2, pp. 150-155, 2003.
- [3] GLinnett L. M., Clarke S. J., Calder B. R., Rzhhanov Y, "The Generation of a Time Correlated 2D Random Process for Ocean Wave Motion," *Conference Publication*, 443, pp.623-626,1997.
- [4] GHenne P. A., "Applide Computational Aerodynamics," *American Institute of Aeronautics and Asrtonautics*, 1990.
- [5] GY. H. Jung, J. S. Youn, H. S. Bang, H. S. Lee, Y. S. Cho and W. C. Choi., "Impulse Analysis of Cannonballs Colliding into Water," *KSPE autums conference*, pp,808-810, 2010.
- [6] Y. H. Jung, J. S. Youn, H. S. Bang, H. S. Lee, Y. S. Cho and W. C. Choi., "Impulse Analysis of Cannonballs Colliding into Water," *KSPE autums conference*, pp,808-810, 2010.
- [7] S. M. Chung, Y. K. Kim, W. C. Choi, H. S. Lee and Y. S. Cho., "Experimetal study on Drag coefficient of Cannonball Colliding into Water Surface," *KSPE autums conference*, pp,949-950, 2012.