

# Designing of Controller based on Artificial Neural Network for Liquid Level System

[ Ankit Kumar, Anirudha Narain ]

**Abstract**—The objective of this paper is to investigate and find a solution by designing the intelligent controllers for controlling liquid level system using Artificial Neural Network. The controllers also can be specifically run under the circumstance of system disturbances. To achieve such objectives, a prototype of liquid level control system has been built and implementations of neural network control algorithms are performed. In neural network control, the approach of Model Reference Adaptive Neural Network Control based on the back propagation algorithm is applied on training the system. The control algorithms based on Neural Network is developed and its performances is observed for the liquid level system.

**Keywords**—Artificial neural Network (ANN), Liquid Level System, Model Predictive Control (MPC), MATLAB/SIMULINK

## I. Introduction

Nowadays, the various parameters in the process of industrial are controlled such as temperature, pressure, and level etc. Some process needs to keep the liquid level in the plant such as oil, water, chemical liquids in tanks. The level control is a type of control method for common in process system. These level control system must be properly controlled by the suitable controller. The main objective of controller in the level control is to maintain a level set point at a given value and be able to accept new set point values dynamically. The traditional proportional-integral-derivative (PID) is commonly utilized in controlling the level of liquid, but the parameter of such controllers must be turned by tuning method either in time response or frequency response to meet their required performances [1,2]. On the other hand, the neural controller is also popularly implemented in many practical industrial automation applications. If the computations are required in a task are well understood, and very efficient algorithms are known, neural networks are inherently well-suited for the implementation [3]. There are so many papers addressed the PID, fuzzy or neural networks control in the water or liquid level control system. Satean Tunyasritur chose PID-fuzzy cascade as the model structure for a linear model based predictive control of the liquid level [4]. Riyaz Shariff utilized artificial neural network (ANN) as advanced process control

technique for water treatment [5]. Corne Liu Lazar Showed a self-learning PID control in the application of level control [6]. Naman et al. presented an adaptive model reference fuzzy controller for controlling the water level in a water tank [7]. Xiao et al. provided a back propagation neural network algorithm used to adjust the parameters of the PID controller and control the liquid level of molten steel smelting non-crystalline [8]. In this paper, we first elaborate the configuration of water level control system. Then, we introduce PID control and model reference adaptive neural network control (MRANNC) [8], [9], [10] strategies based on back propagation algorithm. Finally, some results using MATLAB/SIMULINK are presented for ANN based model predictive controller.

Model Predictive Control refers to a specific procedure in controller design from which many kinds of algorithms can be developed for different systems, it may linear or nonlinear, discrete or continuous. The main difference in the various methods of MPC is mainly the way the control problem is formulated. One of the most popular methods of MPC is Generalized Predictive Control (GPC). GPC was developed by Clarke [11]. The idea of GPC is to calculate future control signals in such a way that it minimizes a cost function defined over a prediction horizon. GPC is capable of controlling processes with variable dead-time, unstable and non-minimum phase systems. In this work, Discrete-time Model Predictive Control (DMPC) is used to control the liquid level of a nonlinear Two Tank Liquid Level System in MATLAB, Simulink environment. At first, Model Predictive Control based on Generalized Predictive Control [12] which is a restricted model approach, is employed. Then a different approach using neural network is used. Artificial Neural Network (ANN) when used with DMPC [13] have many benefits such as, the number of terms used in the optimization problem can be reduced to a fraction of that required by the basic procedure, allows substantial improvements in feasibility [14], two explicit tuning parameters can be used for tuning the closed loop performance with ease and For Multi-Input and Multi-Output (MIMO) configuration both of these tuning parameters can be selected independently for each input. Finally, simulation results are given to demonstrate the performance achieved when both approaches are applied to Single-Input and Single- Output (SISO) nonlinear Two Tank Liquid Level System. Also, the DMPC using Neural Network approach can be applied to MIMO nonlinear Liquid Level System. Model predictive control was introduced successfully in several industrial plants. A good advantage of such control schemes is the ability to handle constraints of actuated variables and internal variables. In most applications of model predictive techniques,

---

Ankit Kumar  
Motilal Nehru National Institute of Technology, Allahabad  
India

Anirudha Narain  
Motilal Nehru National Institute of Technology, Allahabad  
India

a linear model is used to forecast the process behaviour over the horizon of interest [15],[16].

## II. Liquid Level System

### A. Brief Description of Liquid Level System

The control of liquid level in tanks and flow between tanks is a basic problem in the process industries. The process industries require various liquids to be pumped, stored in tanks, then pumped to next tank. Many times these liquids will be processed by chemical or mixing treatment in the tanks, but always the level of liquid in the tanks must be controlled, and the flow between these tanks must be regulated. Often the tanks are coupled together that the levels interact and this must also be controlled. Level and flow control in tanks are at the heart or the main nerve of all chemical engineering systems. But various chemical engineering systems are also at the heart of our economies. Vital industries where liquid level and flow control are necessary include:

- Petro-chemical industries.
- Paper making industries.
- Water treatment industries etc.

### B. Modeling of Liquid Level System

In analyzing systems involving fluid flow, we find it essential to divide flow regimes into laminar flow and turbulent flow, according to the value of magnitude of the Reynolds number. If the Reynolds number is greater than about 3000 to 4000, then the flow is turbulent. The flow is laminar if the Reynolds number is less than about 2000. In the laminar case, fluid flow occurs in streamlines with no turbulence [17]. Systems involving turbulent flow often have to be represented by nonlinear differential equations, while systems involving laminar flow may be represented by linear differential equations. (Industrial processes often involve flow of liquids through connecting pipes and tanks. The flow in such processes is often turbulent and not laminar.)

In this section we shall derive mathematical models of liquid level systems. By introducing the concept of resistance and capacitance for such liquid level systems, it is possible to describe the dynamic characteristics of such systems in simple form.

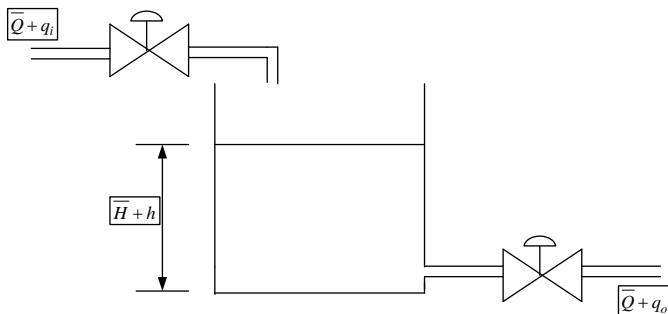

Figure 1. Single Tank Liquid Level System

### Resistance and Capacitance of liquid level systems.

Consider the flow through a short pipe connecting two tanks. The resistance  $R$  for liquid flow in such a pipe or restriction is defined as the change in the level difference (the difference of the liquid levels of the two tanks) necessary to cause a unit change in flow rate; that is,

$$R = \frac{\text{change in level difference, m}}{\text{change in flow rate, m}^3/\text{sec}}$$

Since the relationship between the flow rate and level difference differs for the laminar flow and turbulent flow, we shall consider both cases in the following.

Consider the liquid level system shown in figure 1. In this system the liquid spouts through the load valve in the side of the tank. If the flow through this restriction is laminar, the relationship between the steady state flow rate and steady state head at the level of restriction is given by

$$Q \propto H$$

$$Q = KH \quad (1)$$

Where  $Q$  = Steady-state liquid flow rate,  $\text{m}^3/\text{sec}$

$K$  = Coefficient of proportionality,  $\text{m}^2/\text{sec}$ ,

$H$  = Steady-state head,  $\text{m}$

Notice this law governing laminar flow is analogous to Coulomb's law, which states that the current is directly proportional to the potential difference.

In case of the turbulent flow, the relationship between steady state flow rate and steady state head at the level of restriction is given by

$$Q = K\sqrt{H} \quad (2)$$

Since, 
$$dQ = \frac{K}{2\sqrt{H}} dH \quad (3)$$

$$\frac{dH}{dQ} = \frac{2\sqrt{H}}{K} \quad (4)$$

From equation (2)

We get, 
$$\frac{dH}{dQ} = \frac{2H}{Q} \quad (5)$$

Now we introduced the analogous resistance and capacitance here, ' $r$ ' representing the turbulent flow in the system

$$R_t = \frac{dH}{dQ} \quad (6)$$

$$R_t = \frac{2H}{Q} \quad (7)$$

The value of the turbulent flow resistance  $R_t$  depends upon the flow rate and head. Thus we can say that, the flow rate is defined by

$$Q = \frac{2H}{R_i} \quad (8)$$

The capacitance of the liquid level system can be defined as the change in the quantity of stored liquid to cause a unit change in potential (head).

$$C = \frac{\text{change in liquid stored, m}^3}{\text{change in head, m}}$$

It should be noted that the capacity (m<sup>3</sup>) and the capacitance (m<sup>2</sup>) are different. The capacitance of the tank is equal to its cross-sectional area. If this is constant, the capacitance is constant for any head. Now, consider the system shown in figure 1, the variables are defined as follows:

$\bar{Q}$  = steady-state flow rate, m<sup>3</sup>/sec

$q_i$  = small deviation of inflow rate from its steady-state value, m<sup>3</sup>/sec

$q_o$  = small deviation of inflow rate from its steady-state value, m<sup>3</sup>/sec

$\bar{H}$  = steady-state head, m

$h$  = small deviation of head from its steady-state value, m

as stated previously, a system can be linear if the flow is laminar. Even if the flow is turbulent, the system can be linearized if changes in variables are kept small. Based on the assumption that the system is either linear or linearized, the differential equations of this system can be obtained as follows: since the inflow minus outflow during the small time interval  $dt$  is equal to the additional amount stored in the tank, is given by

$$Cdh = (q_i - q_o)dt \quad (9)$$

Since, we know that

$$q_o = \frac{h}{R}$$

Equation (9) becomes

$$RC \frac{dh}{dt} + h = Rq_i \quad (10)$$

Note that the RC is the time constant of the system. Taking Laplace transform of both sides of equation (10), by assuming zero initial conditions.

$$(sRC + 1)H(s) = RQ_i(s)$$

If we consider,  $q_i$  is input for the system and  $h$  is the output for the system, then the transfer function of the system is given by

$$\frac{H(s)}{Q_i(s)} = \frac{R}{sRC + 1} \quad (11)$$

If the  $q_o$  is taken as the output and the input is  $q_i$ , then the transfer function of the system is given by as follows:

Since,  $q_o = \frac{h}{R}$

Taking Laplace transform both the sides, we get

$$Q_o(s) = \frac{1}{R} H(s) \quad (12)$$

From equation (11) and (12), we obtain

$$\frac{Q_o(s)}{Q_i(s)} = \frac{1}{sRC + 1} \quad (13)$$

### Two Tank Liquid Level System

Consider the two tank liquid level system shown in figure 2. Assuming that the changes in the variables are small. The set point of the controller is fixed ( $r = 0$ ). And we want to obtain the transfer function between the level of the second tank and the disturbance input  $q_d$ .

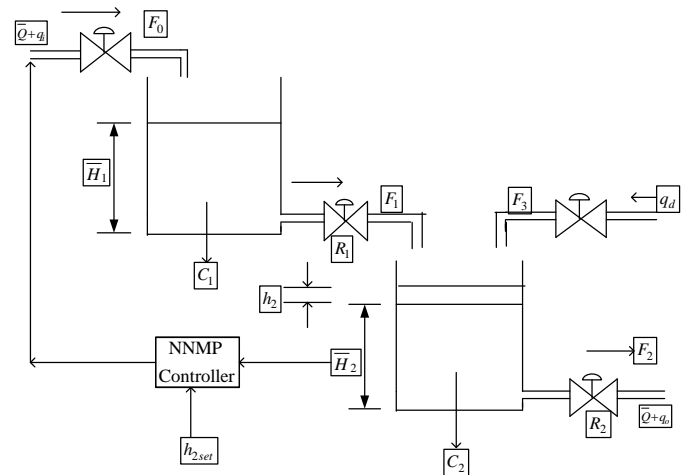

Figure 2. Two Tank Liquid Level System

To investigate the response of the level of the second tank subjected to a unit-step disturbance  $q_d$ , we find it conveniently with the help of the equivalent block diagram of the two tank liquid level system. The main objective is:

To find out the transfer function between  $H_2(s)$  and  $Q_d(s)$ . The two tank liquid level system can be represented with the help of equivalent block diagram shown below

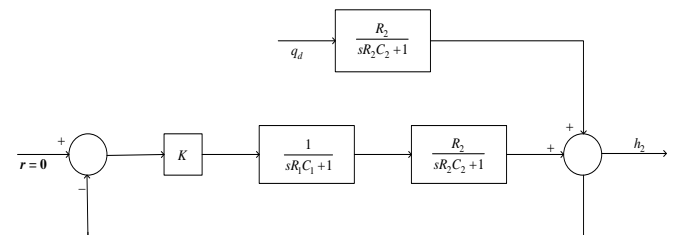

Figure 3. Block diagram representation of Two Tank Liquid Level System

The above block diagram can be modified as

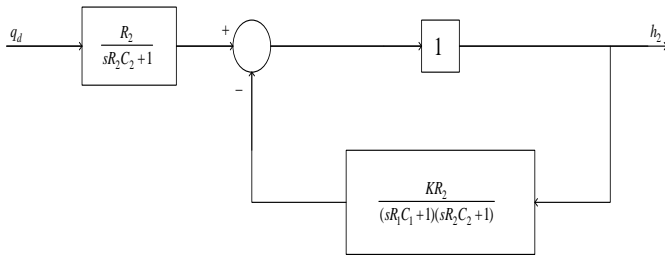

Figure 4. Modified block diagram of Two Tank Liquid Level System

Now the transfer function of the above system is given by

$$\frac{H_2(s)}{Q_d(s)} = \frac{R_2(sR_1C_1 + 1)}{(sR_1C_1 + 1)(sR_2C_2 + 1) + KR_2} \quad (14)$$

In case of the unit-step disturbance-

$$Q_d(s) = \frac{1}{s} \quad (15)$$

The steady-state error would be

$$e_{ss} = \lim_{s \rightarrow 0} \left[ \frac{sR_2(sR_1C_1 + 1)}{(sR_1C_1 + 1)(sR_2C_2 + 1) + KR_2} \right]$$

$$e_{ss} = \frac{R_2}{1 + KR_2} \quad (16)$$

Now on solving equation (14) and (15)

$$H_2(s) = \frac{1}{s} \left[ \frac{R_2(sR_1C_1 + 1)}{(sR_1C_1 + 1)(sR_2C_2 + 1) + KR_2} \right]$$

$$H_2(s) = \frac{1}{sR_1C_1R_2C_2} \left[ \frac{R_2(sR_1C_1 + 1)}{s^2 + \left( \frac{R_1C_1 + R_2C_2}{R_1C_1R_2C_2} \right) s + \left( \frac{1 + KR_2}{R_1C_1R_2C_2} \right)} \right] \quad (17)$$

On comparing the equation (17) with standard second order equation given by  $s^2 + 2\xi\omega_n s + \omega_n^2$

We get, the natural frequency of the system as

$$\omega_n = \sqrt{\frac{1 + KR_2}{R_1C_1R_2C_2}} \quad (18)$$

And the damping ratio of the system as

$$\xi = \frac{1}{2} \frac{R_1C_1 + R_2C_2}{\sqrt{R_1C_1R_2C_2} \sqrt{1 + KR_2}} \quad (19)$$

### III. ANN Based Model Predictive Controller

In this section a procedure for constructing a neural network model predictive controller for the control problem is presented. Here we adopt a procedure in which the controller

is trained directly to minimize the cost for a training data set, without having to compute the optimal MPC control signals by off-line optimizations.

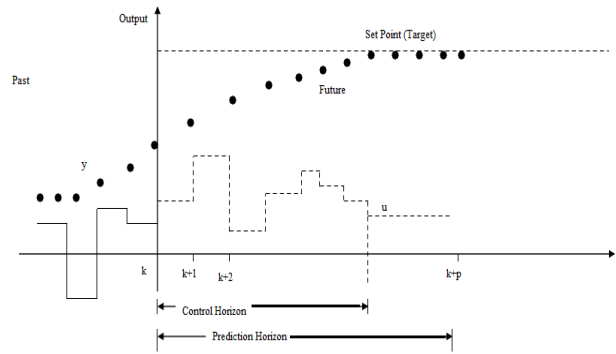

Figure 5. Discrete Model Predictive Control scheme

The controller is represented as

$$u(k) = f(I(k); w) \quad (20)$$

Where  $f(I(k); w)$  is a function approximator,  $I(k)$  denotes the information which is available to the controller at time instant  $k$ , and  $w$  denotes a vector of approximator parameters (neural network weights). If complete state information is assumed, i.e.,  $I(k) = I_{MPC}(k)$ , the controller (20) can be considered as a functional approximation of the optimal MPC strategy. The approach studied here is, however, not restricted to controllers with full state information, and typically the set  $I(k)$  is taken to consist of a number of past inputs  $u(k-i)$  and outputs  $y(k-i)$  as well as information about the set point or reference trajectory  $y_r(k-i)$ . Set the random value for  $I(k)$ .

Note: Besides allowing for controllers of reduced complexity the controller structure may be fixed as well by imposing a structure on the mapping  $f_N(\cdot)$ . For example, assuming that the information has the decomposition

$$I(k) = [I_1(k), I_2(k), \dots, I_r(k)] \quad (21)$$

A decentralized controller :

$u_i(k) = f_{N,i}(I_i(k), w_i)$ ,  $i = 1, \dots, r$  is obtained by requiring that the controller has the structure

$$f_N(I(k), w) = [f_{N,1}^T(I_1(k), w_1), f_{N,2}^T(I_2(k), w_2), \dots, f_{N,r}^T(I_r(k), w_r)]^T \quad (22)$$

For finding the controller parameters  $w$  in such a way that the control law (20) minimizes the cost it is required that the cost is minimized for a set of training data,

$$V^{(m)}(k) = \{x^{(m)}(k), u^{(m)}(k-1), y_r^{(m)}(k+1), \dots, y_r^{(m)}(k+N)\},$$

where  $m = 1, 2, \dots, M$  (23)

Using the control strategy (18), the system evolution for the initial state  $x^{(m)}(k)$  is given by

$$x^{(m)}(i+1) = g(x^{(m)}(i), u^{(m)}(i)) \quad (24)$$

$$\square u^{(m)}(i) = f_N(I(i), w) \quad (25)$$

$$y^{(m)}(i) = h(x^{(m)}(i)), \quad i = k, k+1, \dots \quad (26)$$

Define the associated cost associated with the training data (21),

$$J_N^{(m)}(w) = \sum_{i=k}^{k+N-1} [(y^{(m)}(i+1) - y_r^{(m)}(i+1))^T Q (y^{(m)}(i+1) - y_r^{(m)}(i+1)) + \square u^{(m)}(i)^T R \square u^{(m)}(i)] + q_N(x^{(m)}(k+N)) \quad (27)$$

The training of the function approximator (20) now consists of solving the nonlinear least-squares optimization problem

$$\min_w \sum_{m=1}^M J_N^{(m)}(w)$$

subject to the constraints

$$f_x(x^{(m)}(i+1)) \leq 0 \quad (29)$$

$$f_u(u^{(m)}(i)) \leq 0 \quad (30)$$

$$f_{\square}(\square u^{(m)}(i)) \leq 0, \quad i = k, k+1, \dots, k+N-1 \quad (31)$$

## IV. Simulation Results

The following figure shows the training data set for the Neural Network based Model Predictive Controller, which shows the plant input and plant output before applying the controller, and the error between input and output of the Two Tank Liquid Level System.

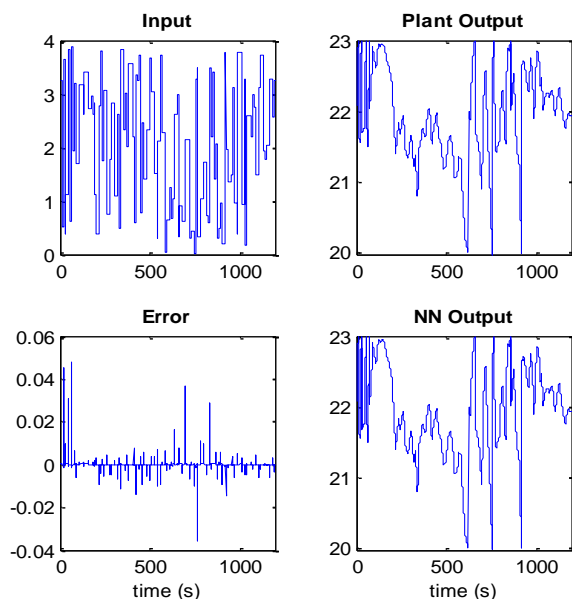

Figure 6. Training data for NN Predictive Control

The following figure represents the validation data for the training of the designed controller.

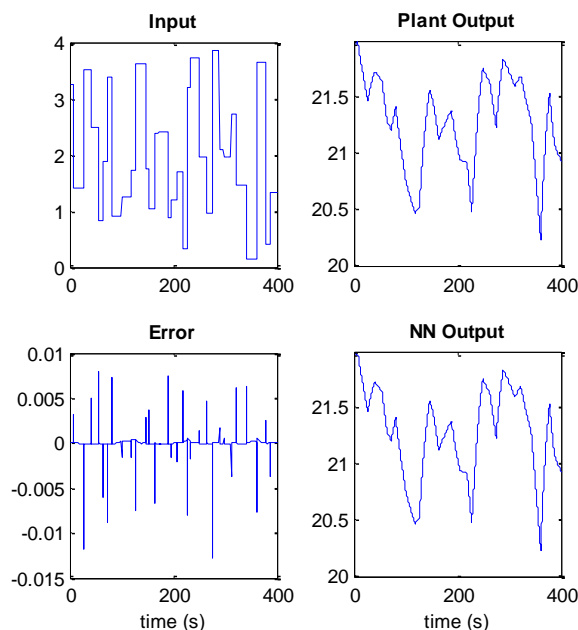

Figure 7. Validation data for NN Predictive Control

The figure shown below exhibits the tank levels of the Two Tank Liquid level System. Here the red coloured curve,  $h_1$  shows the tank level of the liquid in first tank and blue coloured curve,  $h_2$  shows the tank level of the liquid in second tank. The black colour curve,  $h_{2set}$  represent the set value for the controller of the system. This figure shows the liquid level of the tank,  $h_2$  is tracking the set point of the controller,  $h_{2set}$ . In this way, the simulation results for the controller designing for controlling the level of the Two tank Liquid Level System is working properly. And we obtained the satisfactory results for the system.

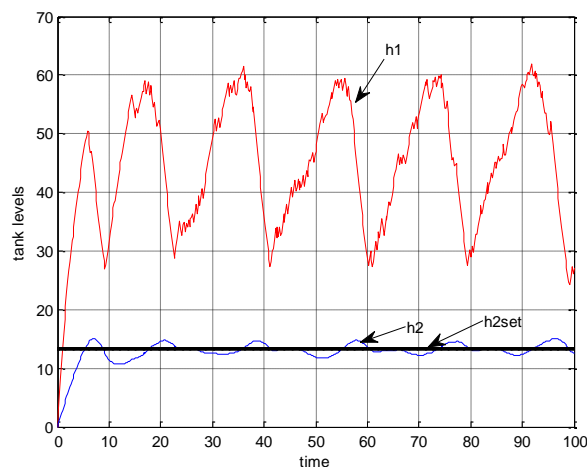

Figure 8. Tank levels of the Two Tank Liquid Level System

The figure 9 shows the flow rates of the two tanks of the liquid level system. The red coloured curve is representing the input flow rate  $F_1$  for the first tank and the blue coloured curve

representing the input flow rate  $F_2$  for the second tank of the Two Tank Liquid Level System presented in this article.

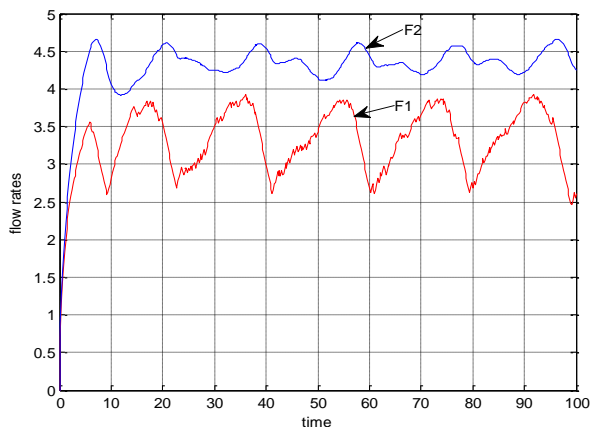

Figure 9. Flow rates of the Two Tank Liquid Level System

## v. Conclusion

The most important aspect of this article is the reduction in execution and computational time. The model predictive control method consists of highly mathematical computations. Moreover, the prediction based on artificial neural networks significantly increase computational demands of the Neural Network Based Model Predictive controllers (NNMPC). Nevertheless, the neural network based Model Predictive Control provides very interesting means to reduce computational costs, because the training times of networks are incredibly less. This kind of artificial neural network could be promising for on-line adaption of the predictor in case of dynamic systems.

## References

- [1] Niimura, T. and Yokoyama, R., "Water level control of small-scale hydro-generating units by fuzzy logic", Proceedings of IEEE International Conference on Systems, Man and Cybernetics, pp. 2483, 1995.
- [2] Roubos, J.A., Babuska, R., Bruijn, R.M. and Verbruggen, H.B., "Predictive Control by Local Linearization of a Takagi-Sugeno Fuzzy Model", IEEE Transactions, 1998.
- [3] N.K. Bose, P. Liang, "Neural network fundamentals with graphs, algorithms and applications", 2001.
- [4] Ghwanmeh, S.H., Jones, K.O. and Williams, D., "On-line Performance Evaluation of a Self-Learning Fuzzy Logic Controller Applied to Non-Linear Processes", IEEE Transactions, 1996
- [5] Riyaz Shariff, Audrey Cudrak and Qing Zhang "Advanced process control techniques for water treatment using artificial neural networks" J. Environ. Eng. Sci. 3(S1): S61-S67 (2004).
- [6] Xiao, Y., Hu, H., Jiang, H., Zhou, J. and Yang, Q., "A Adaptive Control Based Neural Network for Liquid Level of Molten Steel Smelting Noncrystalline Alloy Line", Proc. of 4<sup>th</sup> World Congress on Intelligent Control and Automation, China, 2002.
- [7] Yamada, T. and Yabuta, T., "Dynamic system identification using neural networks", Systems, Man and Cybernetics, IEEE Transactions on, Vol. 23, Issue 1, Jan/Feb, 1993.
- [8] S. Haykin, Neural Networks: "A comprehensive foundation", 2002.

- [9] Narendra, K.S. and Parthasarathy, K., "Identification and Control of Dynamical Systems Using Neural Networks", Neural Networks, IEEE Transactions on, Vol. 1, No. 1, Mar, 1990.
- [10] Takagi, T. and Sugeno, M., "Fuzzy Identification of System and its Application to Modeling and Control", IEEE Transactions on Systems, Man and Cybernetics, Vol. 15, No. 1, 1985.
- [11] D. W. Clarke, C. Mohtadi, and P. S. Tuffs, "Generalized predictive control-part 1: The basic algorithm," Automatica, 137-148 vol. 23, 1987.
- [12] Tan, K.K., Lee, T.H., Hunag, S.N. & Leu, F.M., "PID control design based on a gpc approach," Industrial & Engineering Chemistry Research 41(8), 2002.
- [13] T. Peterson, E. Hernandez, Y. Arkun, and F.J. Schork, "Nonlinear Predictive Control of a Semi Batch Polymerisation Reactor by an Extended DMC." Proc. 1989 American Control Conference, pp. 1534-1539, 1989.
- [14] J. Thibault and B.P.A. Grandjean. "Neural Networks in Process Control: A Survey," Advanced Control of Chemical Processes. K. Najim and E. Dufour. eds. IFAC Symposium Series No. 8, pp. 251-260.
- [15] C. Cutler and B. Ramaker, "Dynamic Matrix Control: A Computer Control Algorithm," Proc. 1980 Joint Automatic Control Conference.
- [16] C.E. Garcia and M. Morari, "Internal Model Control. I. A Unifying Review and Some New Results," Ind. Eng. Chem. Process Des. Dev. 21, pp. 308-323, 1982
- [17] Katsuhiko Ogata, "Modern Control System", 3<sup>rd</sup> edition, Prentice Hall, Upper Saddle River, New Jersey 07458

About Author (s):



**Ankit Kumar** has received his B.Tech degree in 2011 and now pursuing the M.Tech. degree in Control & Instrumentation from Motilal Nehru National Institute of Technology, Allahabad, India. His research interests focus on Control techniques using Artificial Neural Network and Optimization of functions.



**Anirudha Narain** is currently working as Associate Professor in Department of Electrical Engineering at Motilal Nehru National Institute of Technology, Allahabad, India. He has more than 20 years teaching experience to the engineering graduates. His current area of interest is Control, Instrumentation and Model Order Reduction.