

“Hysteresis control for current harmonics suppression using shunt active filter”

Mrs.R.S.Udgave¹
Prof. Y. R. Atre²

Abstract — Recently wide spread of power electronic equipment has caused an increase of the harmonic disturbances in the power systems. The nonlinear loads draw harmonic and reactive power components of current from ac mains. Current harmonics generated by nonlinear loads such as adjustable speed drives, static power supplies and UPS. Thus a perfect compensator is required to avoid the consequences due to harmonics. To overcome problems due to harmonics, Shunt Active Power Filter (SAPF) has been considered extensively. SAPF has better harmonic compensation than the other approaches used for solving the harmonic related problems. The performance of the SAPF depends upon different control strategies. This paper present three-phase active filter to improve power quality. The active power filter (APF) is implemented with PWM based current controlled voltage source inverter (VSI). This VSI switching signals are generated through hysteresis current controller (HCC). The hysteresis band current controller determines the switching signals of the APF, and the algorithm based on instantaneous real active and reactive power method (p-q) theory is used to determine the suitable current reference signals. The shunt APLC system is modeled and simulated in the MATLAB Simulink environment. The simulation results reveal that the active power filter is effectively compensating the current harmonics and reactive power at point of common coupling. The active power line conditioner system is in compliance with IEEE 519 and IEC 61000-3 recommended harmonic standards.

Keywords - Voltage source inverter, Shunt active filter, hysteresis current controller.

Mrs.R.S.Udgave¹,
M.E Electrical Department
A.D.C.E.T.Ashta¹India

Prof. Y. R. Atre²
Professor Electrical Department
A.D.C.E.T.Ashta²India

I. Introduction

Current harmonics produced by non-linear loads, such as switching power supplies and motor speed controllers, are prevalent in today's power systems. These harmonics interfere with sensitive electronic equipment and cause unnecessary losses in electrical equipment. Active power filters were initially proposed by Sasaki and Machida (Sasaki and Machida 1971) as a means of removing current harmonics. An active power filter uses a switching inverter to produce harmonic compensating currents. It is only with the recent advances in semiconductor technology that high-speed, high-power switching devices suitable for constructing active power filters have become available (Duke and Round 1993, Akagi 1996).

II. Active Harmonic Filters

The shunt active power filter (APF) is a device that is connected in parallel to and cancels the reactive and harmonic currents from a nonlinear load. The resulting total current drawn from the ac main is sinusoidal. Ideally, the APF needs to generate just enough reactive and harmonic current to compensate the nonlinear loads in the line. In an APF depicted in Fig. 1, a current controlled voltage source inverter is used to generate the compensating current (i_f) and is injected into the utility power source grid. This cancels the harmonic components drawn by the nonlinear load and keeps the utility line current (i_s) sinusoidal. A variety of methods are used for instantaneous current harmonics detection in active power filter such as FFT (fast Fourier technique) components, SRF method. In this paper, instantaneous real (active) and reactive power method (p-q) theory based algorithm is proposed.

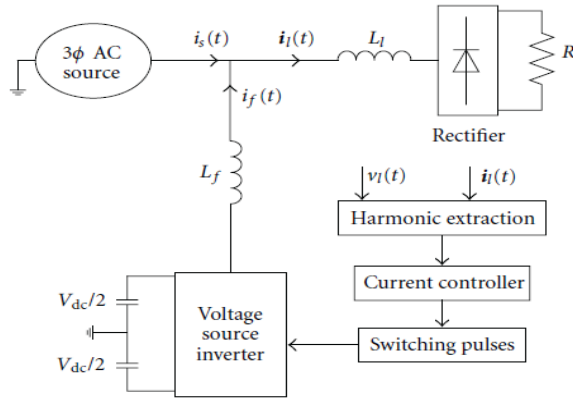

Figure 1: Power System Diagram with APF

iii. Instantaneous Real and Reactive Power Theory

In 1983, Akagi. [1, 2] have proposed the "The Generalized Theory of the Instantaneous Reactive Power in Three phase Circuits", also known as instantaneous power theory, or p-q theory. The p-q theory consists of an algebraic transformation (Clarke transformation) of the three-phase voltages and currents in the a-b-c coordinates to the α - β -0 coordinates, followed by the calculation of the p-q theory instantaneous power components.

The relation of the transformation between each component of the three phase power system and the orthogonal coordinates are expressed in space vectors shown by the following equations in terms of voltage and current as shown in equation 1.

$$\begin{bmatrix} v_\alpha \\ v_\beta \end{bmatrix} = \frac{\sqrt{2}}{\sqrt{3}} \begin{bmatrix} 1 & -1/2 & -1/2 \\ 0 & \sqrt{3}/2 & -\sqrt{3}/2 \end{bmatrix} \begin{bmatrix} v_a \\ v_b \\ v_c \end{bmatrix} \quad \dots\dots(1)$$

The three phase coordinates a-b-c is mutually orthogonal. As a result, the conventional power for three phase circuits can be derived by using the above equations. The instantaneous active power of the three phase circuit, p, can be calculated as shown in equation 2.

$$\begin{bmatrix} i_\alpha \\ i_\beta \end{bmatrix} = \frac{\sqrt{2}}{\sqrt{3}} \begin{bmatrix} 1 & -1/2 & -1/2 \\ 0 & \sqrt{3}/2 & -\sqrt{3}/2 \end{bmatrix} \begin{bmatrix} i_a \\ i_b \\ i_c \end{bmatrix} \quad \dots\dots(2)$$

and the instantaneous real power is defined as follows in equation 3.

$$P = v_\alpha i_\alpha + v_\beta i_\beta + v_c i_c \quad \dots\dots(3)$$

From these equations, the instantaneous power can be rewritten as shown in equation 4.

$$\begin{bmatrix} P \\ Q \end{bmatrix} = \begin{bmatrix} v_\alpha & v_\beta \\ -v_\beta & v_\alpha \end{bmatrix} \begin{bmatrix} i_\alpha \\ i_\beta \end{bmatrix} \quad \dots\dots(4)$$

As the compensator will only compensate the instantaneous reactive power, the real power is always set to zero. The instantaneous reactive power is set into opposite vectors in order to cancel the reactive component in the line current. From the equation 2 & 3, yields equation 5.

$$\begin{bmatrix} i_\alpha \\ i_\beta \end{bmatrix} = \begin{bmatrix} v_\alpha & v_\beta \\ -v_\beta & v_\alpha \end{bmatrix}^{-1} \begin{bmatrix} P \\ Q \end{bmatrix} \quad \dots\dots(5)$$

By deriving from these equation, the compensating reactive power can be identified. The compensating current of each phase can be derived by using the inverse orthogonal transformations as shown below in equation 6.

$$\begin{bmatrix} i_{c\alpha}^* \\ i_{c\beta}^* \\ i_{c0}^* \end{bmatrix} = \frac{\sqrt{2}}{\sqrt{3}} \begin{bmatrix} 1 & 0 \\ -1/2 & \sqrt{3}/2 \\ -1/2 & -\sqrt{3}/2 \end{bmatrix} \begin{bmatrix} i_{c\alpha} \\ i_{c\beta} \end{bmatrix} \quad \dots\dots(6)$$

iv. Hysteresis Current control

Active filters produce a nearly sinusoidal supply current by measuring the harmonic currents and then injecting them back into the power system with a 180° phase shift. A controlled current inverter is required to generate this compensating current. Hysteresis current control is a method of controlling a voltage source inverter so that an output current is generated which follows a reference current waveform. This method controls the switches in an inverter asynchronously to ramp the current through an inductor up and down so that it tracks a reference current signal. Hysteresis current control is the easiest control method to implement (Brod and Novotny 1985). A hysteresis current controller is implemented with a closed loop control system and is shown in diagrammatic form in Figure 2(a). An error signal, $e(t)$, is used to control the switches in an inverter. This error is the difference between the desired current, $i_{ref}(t)$, and the current being injected by the inverter, $i_{actual}(t)$. When the error reaches an upper limit, the transistors are switched to force the current down. When the error reaches a lower limit the current is forced to increase. The minimum and maximum values of the error signal are e_{min} and e_{max} respectively. The range of the error signal, $e_{max} - e_{min}$, directly controls the amount of ripple in the output current from the inverter and this is called

the Hysteresis Band. The hysteresis limits, e_{min} and e_{max} , relate directly to an offset from the reference signal and are referred to as the Lower Hysteresis Limit and the Upper Hysteresis Limit. The current is forced to stay within these limits even while the reference current is changing. The ramping of the current between the two limits is illustrated in Figure 2(b). The switching frequency is altered by the width of the hysteresis band, the size of the inductor that the current flows through (L in Figure 2(a)) and the DC voltage applied to the inductor by the inverter. A larger inductance will yield a smaller di/dt for a given voltage and so the slope of the sawtooth waveform in Figure 2(b) will be less.

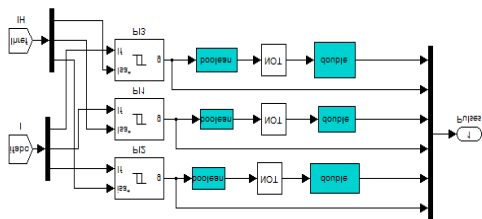
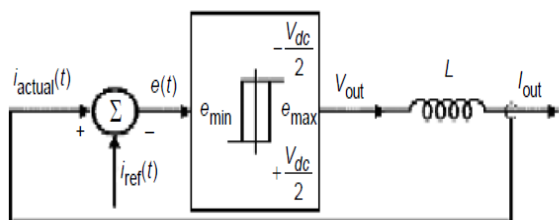

Figure a

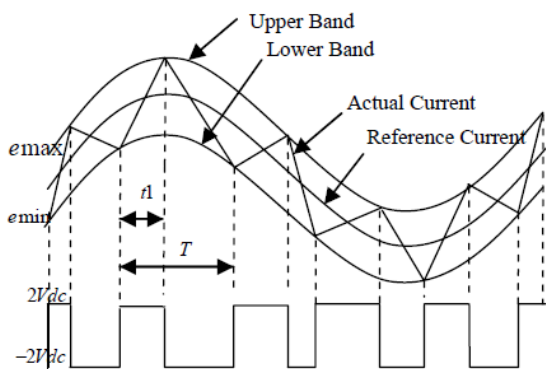

Figure b

Figure 2 Hysteresis current controller (a) block diagram and (b) operational waveform

v. Simulation Results

The performance of the three-phase four-wire shunt APLC system is evaluated through Matlab programs in order to program and test the system under unbalanced non-linear load conditions. The system parameters values are; Line to line source voltage is 440 V; System frequency (f) is 50 Hz; DClink capacitor $C1=1100 \mu\text{F}$ and $C2=1100 \mu\text{F}$; Reference dc voltage 850 V; Interface inductor is 4 mH and 1Ω full bridge rectifier load $100+j 50 \Omega$.

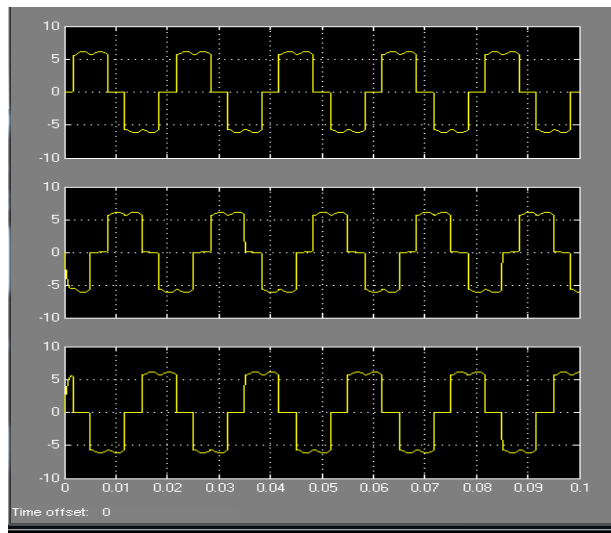

Figure 3. Source current before compensation

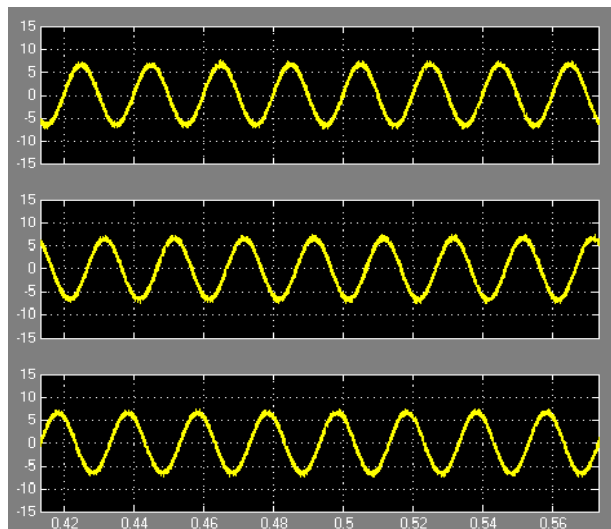

Figure 4. Source currents after active power filter compensation

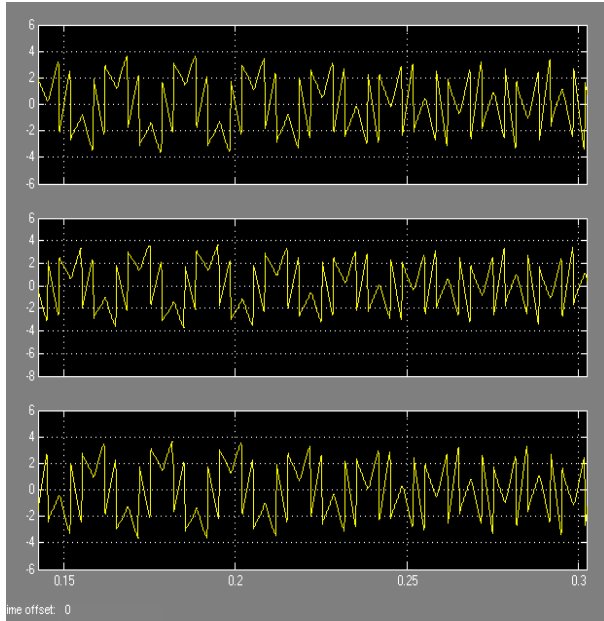

Figure 5. Compensation or filter current

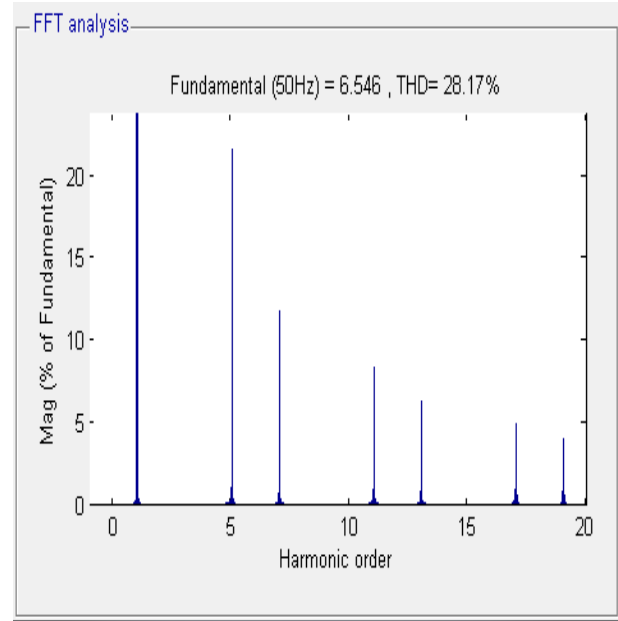

Figure a

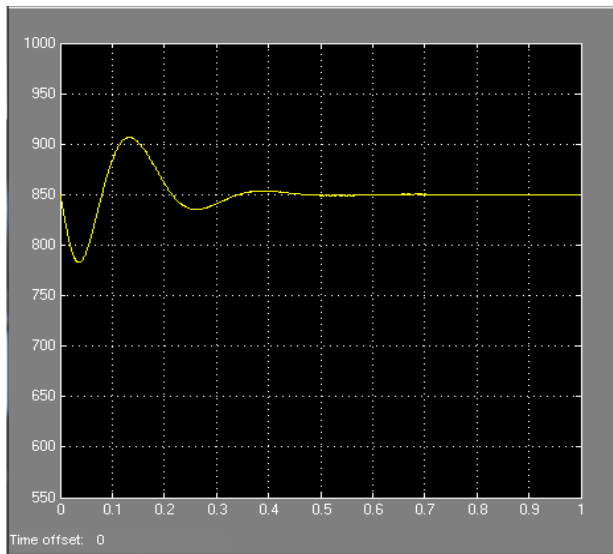

Figure 6. DC Capacitor voltage

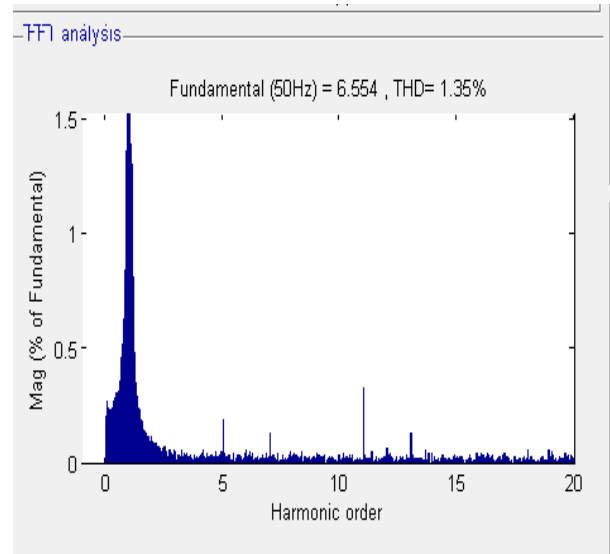

Figure b

Figure 7. Order of harmonics (a) the source current without active filter (THD=28.17%), (b) with active power filter(THD=1.35%)

vi. Conclusion

This paper presents implementation of a hysteresis current control scheme for three-phase active power line conditioners. This active power filter system is tested and verified using MATLAB program. The performance of the system improves and there is a reduction in Total Harmonic Distortion from 28.17% to 1.35%. These results demonstrate that the active filter is effective in compensating current harmonics that facilitates improves power quality in the distribution network

References

- [1] Joachim Holtz, "Pulse width Modulation-A Survey," IEEE Trans. Industrial Electronics, Vol.39, NO.5, Dec1992, pp-410-420.
- [2] Hirofumi akagi, fellow, ieee " Active Harmonic Filters", Authorized licensed use limited to: IEEE Xplore. Downloaded on March 24, 2009 at 04:08 from IEEE Xplore..
- [3] D.M.Brod and W.Novotny, "Current Control of VSI-PWM Inverters", *IEEEIAS 1984 Annual Meeting*, 1984, pp.418-425.
- [4] J.W. Dixon, J. J. Garcia, and L. Moran, "Control system for three-phase active power filter which simultaneously compensates power factor and unbalanced loads," IEEE Trans. Ind. Electron., vol. 42, no.6, pp. 636-641, Dec. 1995.
- [5] M.P.Kazmierkowaski, L.Malesani: "PWM Current Control Techniques of voltage source converters-A Survey" IEEE. Trans. On Industrial Electronics, Oct.1998.Vol.45, no.5, pp.691-703.
- [6] B.K.Bose, "An Adaptive Hysteresis-Band Current Control Technique of a Voltage Fed PWM Inverter for Machine Drive System", *IECON 1988*, pp.684-690.
- [7] L.Malek and P.Tenti: "A novel hysteresis control method for current controlled VSI PWM inverters with constant modulation frequency". IEEE Trans. on Industry Applications, Vol.26, No. 1, Jan./Feb. 1990, pp.88-92.
- [8] Vasco Soares , Pedro Verdelho and Gil Marques. "An Instantaneous Active and Reactive Current Component Method for Active Filters." IEEE Trans, vol 15, No 4, July 2000 ,pp- 660-669.
- [9] Amrith Chandra, Bhim Singh, B. N. Singh and Kamal Al-Haddad. "An Improved Control Algorithm of Shunt Active Filter for Voltage Regulation, Harmonic Elimination, Power-Factor Correction, and Balancing of Nonlinear Loads" IEEE Trans, Power Electronics, Vol. 15, No. 3, May 2000, pp- 495-507.
- [10] Edson H.Watanabe, Hirofumi Akagi, Maurício Aredes "The p-q theory for active filter control: some problems and solutions" Revista Controle & Automação/Vol.15 no.1/Jan., Fev. e Março 2004.