

Resistivity Imaging of a Phantom with Irregular Inhomogeneities with 16 Copper Electrodes Based Sensory System in 2 Dimensional Electrical Impedance Tomography

Deborshi Chakraborty¹, Madhurima Chattopadhyay², Radhaballabh Bhar³

Abstract— In this paper, the fabrication of 16-copper electrode based electrical impedance tomography (EIT) system is fabricated. EIT is a tool for imaging the interior permittivity distribution of an object (stone/tumor) by measuring voltage at the surface. This method is useful for detecting the shape, size and position of unwanted lumps within a specified area. In order to understand the proposed work, a simulation study using Finite Element Method (FEM) based Multiphysics software has been performed, in which we have imaged perfectly the shape, position and sizes of both the regular and irregular shaped objects situated within a specified phantom area in a 2D plane. Simultaneously, we have developed a real-time system consists of 16 copper electrodes (placed equidistantly) detect non-conducting like plastic container in normal saline solution. We have injected a constant current to the phantom boundary and the surface potentials are being measured using neighbouring method. We have collected the output data sets and reconstructed the voltage density distribution plot using FEMM tool. The resulting images show that the resistivity profiles of the phantom for various events are successfully observed.

Keywords— *Electrical Impedance Tomography (EIT), Finite Element Method (FEM), lumps, surface charge density*

I. Introduction

EIT is a non invasive tool for imaging the interior permittivity distribution of an object by measuring voltage at the surface and then reconstructing it to an image. EIT depends mainly on the electrical properties of the materials, mainly conductivity of material which is placed inside the phantom under observation [1-3]. Harmful radiations are not involved in this process of imaging. For biomedical field it identifies information from the electrical properties of tissue [4]. It is an emerging methodology for use in medical applications. In the near future, there may be a possibility for the replacement of the conventional medical imaging techniques by EIT.

Deborshi Chakraborty
Heritage Institute of Technology, Kolkata: 700104
West Bengal, India

Madhurima Chattopadhyay,
Heritage Institute of Technology Kolkata: 700104
West Bengal, India

Radhaballabh Bhar
Dept. of Instrumentation Science, Jadavpur University, Kolkata: 700032
West Bengal, India

Computed Tomography (CT), Mammography, Magnetic Resonance Imaging (MRI), Positron Emission tomography (PET), Ultrasound and Thermal imaging are the conventional imaging techniques mentioned above [5]. All these techniques deals with either harmful radiations which may cause side effects to body tissues or very expensive.

Study of the impedance image reconstruction techniques with practical phantoms is necessary to analyze the performance of an EIT system. EIT systems with practical phantoms with saline and solid resistive materials are very popular [6]. EIT is very valuable due to its cost effectiveness i.e. it is affordable to common man and portability.

In this paper, firstly the FEM Multiphysics based simulation studies were performed and then real time implementations of EIT system with 16 copper electrode system were fabricated. An EIT system composed of two parts, a data acquisition hardware and an image reconstruction software [7, 8].

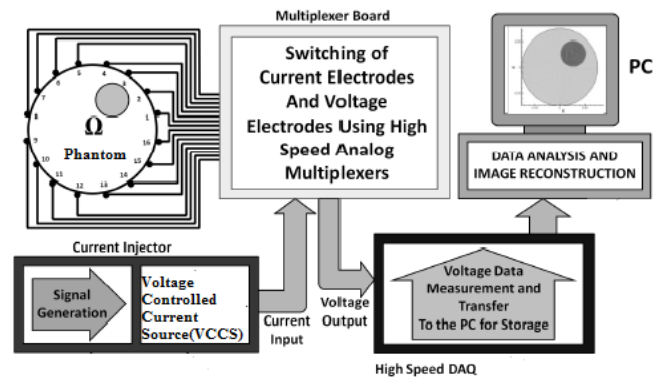

Fig. 1 shows the basic block diagram of EIT system. It is mainly comprised of

- i) an array of electrodes, attached to the surface of the phantom and the normal saline as a conducting medium
- ii) a voltage source (0-15V), which applies an dc voltage to the electrodes and measures the resultant voltage distribution on the surface of the phantom.
- iii) an image reconstruction algorithm, which reconstructs images from the voltage difference as measured from the surrounding electrode array.
- iv) a user interface (display, hardcopy, keyboard, storage facilities, etc.) to enable an easy user access to the image analysis.

II. Experimental Details

A. FEM Based Study

(a) Model Definition

This model solves Gauss' law with $\rho = 0$. Using Poisson's equation we have [9]:

$$-\nabla(\epsilon_0 \epsilon_r \nabla V) = -\rho \quad (1)$$

where ϵ_0 is the permittivity of the free space and ϵ_r is the permittivity of the object which is in our investigation.

Here a cylindrical space is considered which contains air with ϵ_r equal to 1 and the different objects with varying permittivity's from 4 to 16 are considered. The voltage difference, is created by setting $V = 0$ volt on the bottom and $V = 10$ volt on top of the cylinder. On all the other boundaries, electric insulation condition as given in Eqn. 2 is used.

$$n \bullet D = 0 \quad (2)$$

(b) Model Designs

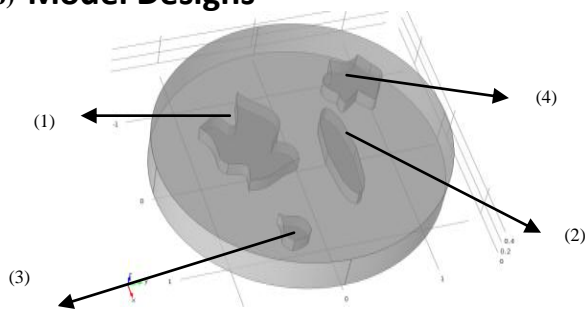

Figure 2. Photograph of the constructed model

Details of the objects under consideration:

Table I

Specifications of the constructed cylinder		
Radius(cm)	Height(cm)	Relative Permittivity(ϵ_r)*
1	0.2	100

Table II

Objects shown in Fig. 1	Specifications of the object (lumps)	
	Height(cm)	Relative Permittivity(ϵ_r)*
1	0.2	40.678 X 10 ³
2	0.2	80.678 X 10 ³
3	0.2	60.678 X 10 ³
4	0.2	30.678 X 10 ³

(* values of relative permittivities obtain from [12])

A slice of a cylindrical volume is considered with four objects of different shaped and of same height. These bodies are assumed to be lumps (tumors) inside the human kidney and having different permittivity ranging from (30-80) X 10³. An overall permittivity inside the block is taken equal to 100. The model is converted to 3D platform from the 2D design FEM platform. Extremely fine physics controlled meshing (details provided below) is applied and the experimental study has performed. An electrical potential of 10V is applied at the top surface of the block and on the bottom surface a ground potential of 0V is applied and other sides are kept insulated.

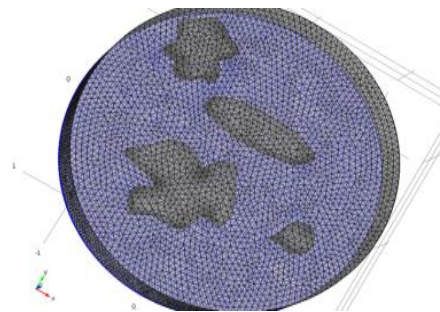

Figure 3. Photograph of the constructed model with meshing

Details of the meshing:

- Maximum element size: 0.038 cm
- Minimum element size: 0.001 cm
- Maximum element growth rate: 2.4
- Resolution of the curvature: 0.4
- Resolution of the narrow region: 0.7

(c) Results and discussions of FEM study

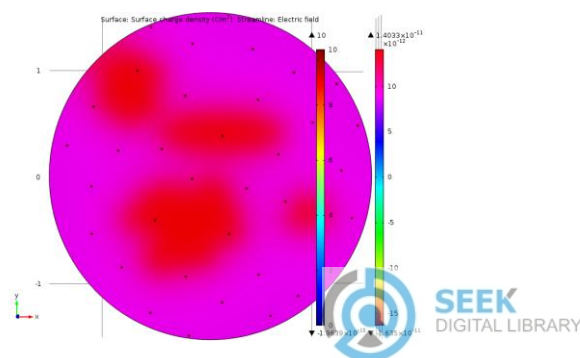

Figure 4. Photograph determining the shape of the objects placed inside from the top of the cylinder by noting the surface charge density

It can be easily visualized from Fig.4, that the surface charge density is higher for the higher permittivity objects as expected. Fig. 4 shows the variation of electrical field along z-axis.

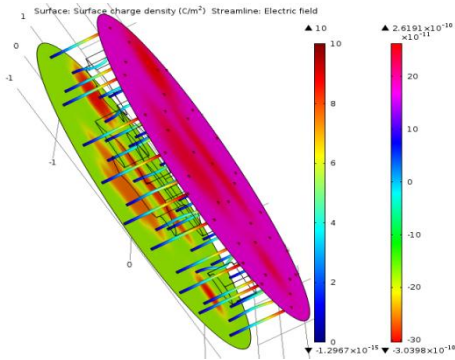

Figure 5 Photograph showing the variation of surface charge density, electric field (streamline density) along z-axis within the specified volume.

B. Implementation Of Real Time EIT System

The experimental set up developed by us consists of 16 copper electrodes, Single Pole Single Throw (SPST) slide actuated DIP switch-based multiplexers is used for electrode switching module which is operated manually for injecting current and measuring the voltage, a dc 0-15 V supply, XRT 111 as Voltage Control Current Source (VCCS), multiplexer for and adruino uno board for pc based data acquisition. The block diagram of the developed sensory system is given in Fig.6 and the real time implemented system is provided in Fig. 7.

This real time implementation focuses on the EIT experiments performed using normal saline with 0.9 % of sodium chloride in a plastic container (phantom). The diameter of plastic container is 30 cm and height is 10 cm and the volume of normal saline used is 360 ml. Electrical conductivity of normal saline is 300 mS/m.

(a) Data Collection

The 16 copper electrodes are placed on phantom equidistantly and normal saline is used as a conducting medium. The non conducting impurities are inserted at different positions within the phantom in presence of normal saline water. Following the

neighbouring pattern current injection protocol constant current of 1A is applied across two electrodes at a time but current can also be applied through opposite, cross and adaptive method [2, 7, 9, 10]. The setup of experiment is shown in figure 2. For example, in a set of 16 electrodes the current is applied between electrode pair 1-16 and the voltage is measured between 2-3, 3-4 and so on (excluding source pair electrodes). Thus the first 13 readings are obtained. The current source is then shifted to pair 1-2, 2-3...etc and the procedure is repeated to get the next set of 13 readings [7, 9, 10]. Then, the voltage difference is measured between adjacent electrodes [1, 9]. All these voltage readings are taken manually and it takes nearly 15 minutes to take one set of voltage readings. The non conducting impurity used in this experiment is plastic cylinder of 5cm diameter and 15 cm height. After taking all the voltage set readings finite element method is used for reconstruction of images.

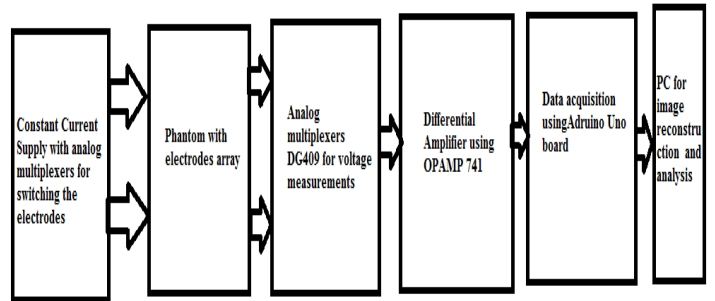

Figure 6. Block diagram of the 16 Cu Electrode based EIT system

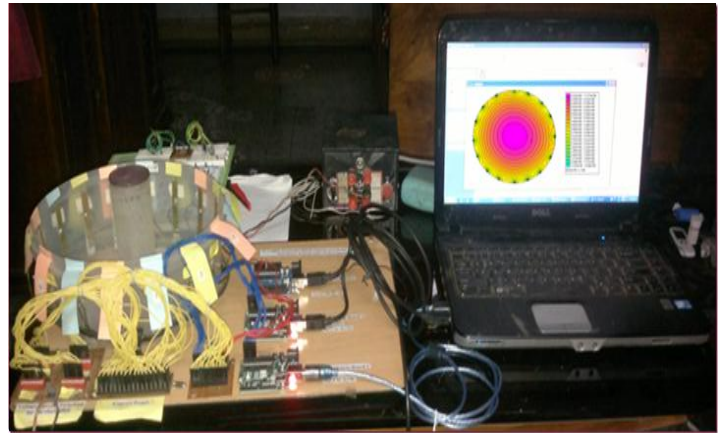

Figure 7. Photograph for the experimental setup

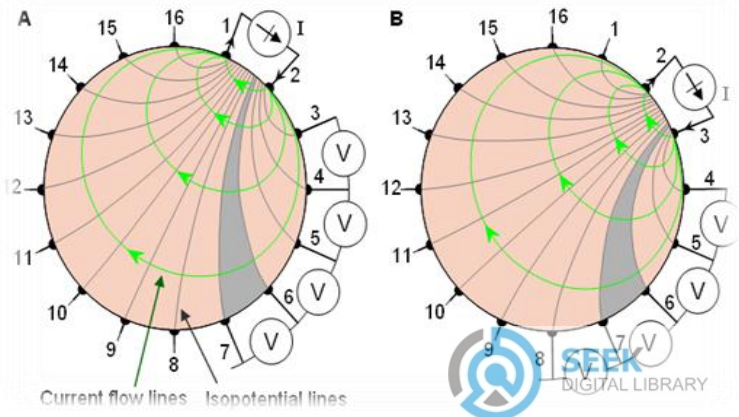

Figure 8. Adjacent pattern of voltage measurements

(b) Finite Element Method based image reconstruction

The FEM method has developed concurrently with the expanding use of high speed computers with the growing emphasis on iterative methods for engineering analysis. This method was firstly used for structural analysis, the general nature of the theory on which it is based, made possible for application in various fields like medical imaging. Problems involving complex material properties like human tissues are solved using numerical methods [10] and these methods do not provide exact but approximate and barely acceptable solutions [11]. Figure 4(a) shows the container filled with normal saline and with no impurity. The density distribution is uniform in this case and can be seen in FEM Graph as shown beside it. The uniform sunshine yellow color indicates the almost constant potential in the phantom. The ochre yellow spots show the very small increase in voltage near the electrodes. Then, two types of impurities of the known area are inserted one after the other in the normal saline and the readings are taken. The superimposed voltages appearing on the surface of phantom are used to reconstruct the impedance images.

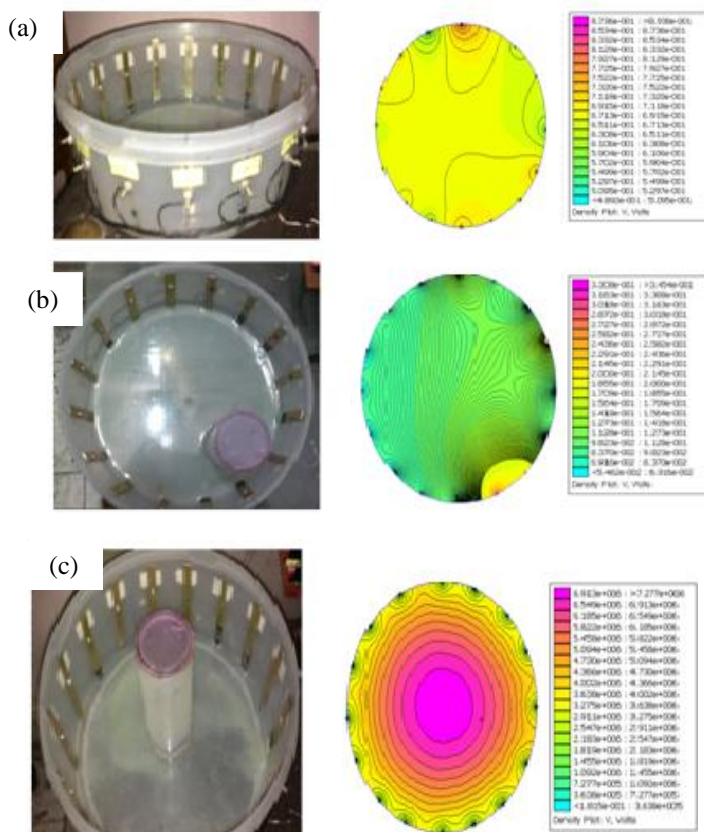

Figure 9. EIT system with (a) normal saline water (b) object (plastic container) is placed at one of the corner, (c) object (plastic container) placed at the centre, of the phantom and its voltage density plots using FEMM tool.

III. Results And Discussions

The FEM based voltage density plots as obtained in Fig. 9(a, b, c), indicates the position of the impurity present within the closed specified phantom area. It is impossible to detect the actual size as well as the shape of the impurity present. The profile of the potential lines in the FEM graph is studied. It is visualize that when the non-conducting impurity is placed inside the phantom, the equipotential lines gets deviated and leave the non-conducting object. Thus, the voltage measured near impurity is high i.e. the conductivity is low.

IV. Conclusions

The Electrical Impedance Tomography is a non radiating, safe, portable and affordable imaging technique. The disadvantage of an EIT includes its poor spatial resolution. By increasing the number of electrodes the performance of EIT system can be improved. Due to the fixed size of the phantom circumference, the size of the electrodes can be kept optimum to achieve best resolution. The distribution of the colour profile in the voltage density plots of FEM graph indicates the presence, the type and the location of the unwanted lumps. This technique can be used for various applications ranging from monitoring the condition of human thorax during breathing, lung fluid detection, imaging of human brain and stomach for gall bladder stones, hyperthermia, foetal movement, imaging of intravascular hemorrhage in infants etc.

References

- [1] Mohd Tahir Erwati, & Nagi Farrukh, "Applications of electrical impedance tomography for imaging in biomedical and material technology", Proc. of 2009 IEEE Students Conference on research and development.(SCoREd 2009), 16-18 Nov '09, UPM Serdang, Malaysia.
- [2] Sarwan Kumar, Sneha Anand & Amit Sengupta, "Impedance based image reconstruction of the field distribution inside the closed phantom using finite element method", (IJCN) International journal of computer and network security. Vol. 2, No 7, July 2010.
- [3] Y. Zou & Z. Guo, "A review of electrical impedance techniques for breast cancer detection" Elsevier Medical Engineering and Physics 25 / (2003).
- [4] Jianjun Zhang, Weili Yan, Guizhi Xu & Quanming Zhao, "A New Algorithm to Reconstruct EIT Images; Node Back Projection Algorithm", Proceedings of the 20th Annual International conference of IEEE EMBS. Cite Internationale, Lyon, France August 23-26, 2007.
- [5] John G. Webster, "Medical Instrumentation Application and Design", third edition, Wiley India, 2007.,

- [6] T. K. Bera & J. Nagaraju, "Studying the resistivity imaging of chicken tissue phantoms with different current patterns in Electrical Impedance Tomography(EIT)",*Measurement*(2012),doi:10.1016/j.measurement.2012.01.002.
- [7] Manuchehr Soleimani, "Electrical impedance tomography system: an open access circuit design"*Biomedical Engineering Online*, 03 May 2006.
- [8] "Medicalphysics And Biomedical Engineering", Department of Medical Physics and Clinical;] B H Brown, R H Smallwood, D C Barber, P V Lawford & D R Hose, Medical Science Series Engineering, University of Sheffield and Central Sheffield University Hospitals, Sheffield, UK Institute of Physics Publishing Bristol and Philadelphia(1999), chapter 12.
- [9] Deborshi Chakraborty, Madhurima Chattopadhyay; "Design and performance evaluation of a sensor based on Electrical Impedance Tomography";,978-1-4673-2620-9/12©IEEE.
- [10] Holder DS, "*Electrical Impedance Tomography*", IOP Publishing, Bristol, UK, 2004.
- [11] Desai & Abel, "*An introduction to finite element method*" Affiliated east west press, New Delhi, 1972
- [12] Nataliya Kovalchuk "*Advances in Magnetic Resonance Electric Impedance Mammography*".,published by UMI Microform 3326035, Copyright 2008by ProQuest LLC.

About Author (s):



Deborshi Chakraborty is currently perusing M.Tech. in Applied Electronics and Instrumentation Engineering department in Heritage Institute of Technology, Kolkata. He had completed his B.Sc. (Honours) in physics from University of Calcutta in 2009 and M.Sc. in Instrumentation from Jadavpur University in 2011. He is a gold medalist in M.Sc. from Jadavpur University. He's interest of research includes both designing and fabrication of sensors and transducers for industrial as well as for biomedical applications..He has over 9 publications in International/National conferences and journals of repute



Dr. Madhurima Chattopadhyay is associated with Heritage Institute of Technology as a professor in the department of Applied Electronics and Instrumentation Engineering. She has achieved Ph.D.(Engg.) from IISc., Bangalore. She is a B.Tech. from Jadavpur University and M.Tech from University of Calcutta. She has more than 13 years experience in teaching and published more than 35 papers in international journals and conferences. Her research interests MEMS based sensor, Power Electronics drive circuits, Biomedical Instrumentation etc.



Prof.(Dr.) Radhaballabh Bhar is associated with Jadavpur University, Kolkata. He is the Head and also as a professor of the the Department of Instrumentation Science He has completed his M.Sc. from Jadavpur University, M.Tech. from Indian Institute of Science Bangalore and PhD from Jadavpur University. He had more than 150 publications in reputed journals and conferences.