

Predicted and Observed Analysis of Micro Photovoltaic Stand-alone Power Plant

S. Bhattacharjee and S. Bhakta

Abstract—Due to global energy crisis and environmental reasons, the importance of renewable energy and its popularity are increasing day by day. Amongst the all renewable energy resources, solar photovoltaic (PV) plants are extensively adopted in many countries for power generation. The paper presents the annual performance prediction of a 1.2 kW_p PV power plant along with some monitored results from such existent power plant.

Keywords—PV power plant, load profile, solar radiation, PV power production.

I. Introduction

In the last couple of years, global warming and energy policies have attained significant importance across the world in order to reduce greenhouse gas emissions. Renewable energy sources are identified as a sustainable alternative for clean energy generation. Among renewable energy sources, photovoltaic (PV) system appears to be one of the most promising clean power generation technologies [1]. Also the PV production has been grown more than 35% per year in last decade [2,3]. Currently, PV is most competitive in isolated sites, away from the electric grid and requiring relatively small amounts of power, typically less than 10 kW_p. In these off-grid applications, PV is frequently used in the charging batteries, thus storing the electric energy produced by the modules and providing the user with electrical energy or demand. The geographical location and all the linked meteorological variable can play a significant role on the energy outcome of specific PV installation [4]. The present paper focuses on the performance of 1.2 kW_p PV power plant located in an educational institute of north-east India state Tripura. Annual performance of the plant has been predicted using hybrid optimization model for electric renewable (HOMER), developed by National Renewable Energy Laboratory (NREL) of USA. Besides, the observed results of the plant during summer have been analysed in the paper.

Dr. Subhadeep Bhattacharjee
National Institute of Technology (NIT), Agartala
India

Mr. Shubhashish Bhakta
National Institute of Technology (NIT), Agartala
India

I. Description of the system

A. PV system

The system comprises an array of PV module (Fig.1), connected to a battery bank through a charge controller. The charge controller switches off the PV array when the battery is fully charged and switches off the load when the battery becomes discharged. The battery bank stores energy produced during sunny periods for use in cloudy and rainy conditions. Neither there is any backup power supply in this system nor connected to utility grid. The designed PV system for simulation includes PV panel, converter, battery bank, and primary load as shown in Fig.2. The size of PV panel is 1.2 kW_p with degradation factor and life time are considered to be 90% and 20 years respectively. No tracking system has been considered but the effect of ambient temperature is taken into account. The array slope angle is set to 23° and the array azimuth is 0° which is referring to the south direction. The size of the converter is considered as 2 kW with efficiency of 90%. Battery is considered to be lead acid because of their low cost and availability [5]. The input parameters for lead acid battery used in simulation are 2V, 400Ah nominal capacity, round trip efficiency of 86%, minimum state of charge 30%, float life of 20 years, 1A/Ah maximum charge rate, 60 A maximum charge current, and 1823 kWh of lifetime throughput. The energy storage by single battery is 800 kWh i.e. product of nominal voltage and nominal capacity. In this simulation number of batteries per string is 24 with 48 V bus voltage and string size input is 0 and1. The capital cost of the system is considered as: PV: \$2599, battery: \$3116 and converter: \$602, neglecting replacement, and operation and maintenance (O&M) cost.

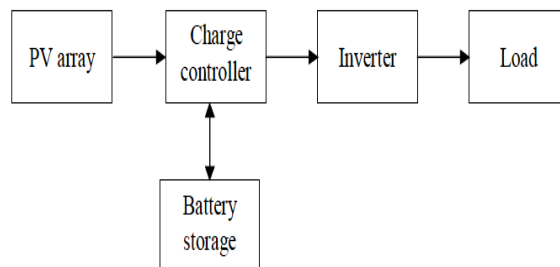

Figure 1. Block diagram representation of the stand-alone PV system

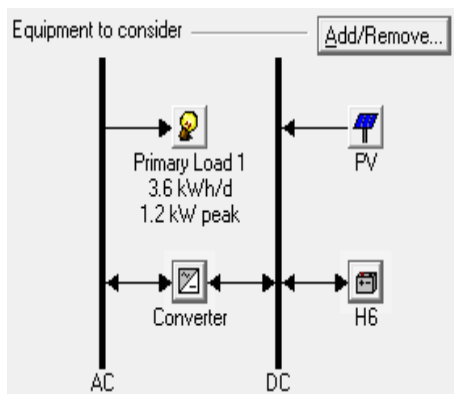

Figure 2. System sizing

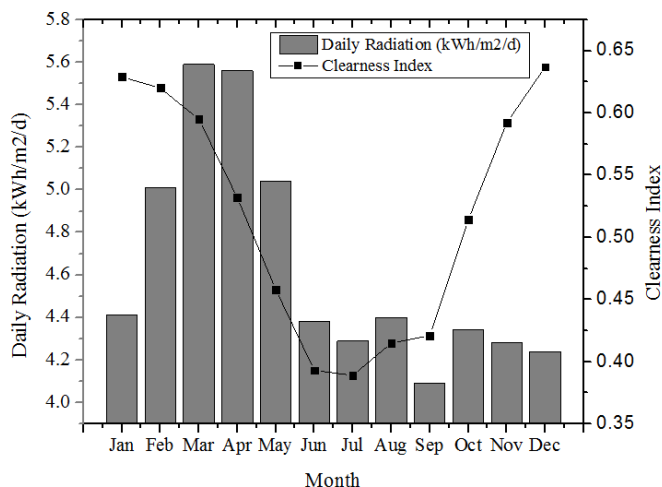

Figure 3. Solar resource profile

B. Load profile

The load profile is modeled according to the demand in a single room laboratory of the institution. The possible electrical appliances used in this room are computer, tube light, and fan. The number of appliances, rating, and their actual hour of operation during two main seasons are shown in Table I. The maximum daily demand in summer and winter months are 700 W and 340 W respectively. The loads are utilized about 8 hours from 9:00 am to 5:00 pm. HOMER calculates the monthly average load as 3.6 kWh/day with peak demand of 1.2 kW and load factor of 0.121.

TABLE I. LOAD PROFILE

Summer				
Load	Number	Power (Watt)	Use (hour)	Energy demand (Wh/day)
Computer	3	60	8	1,440
Fan	4	90	8	2,560
Tube light	4	40	8	1,280
Total				5,600
Winter				
Computer	3	60	8	1,440
Tube light	4	40	8	1,280
Total				2,720

C. Solar radiation resources

The most appropriate installation sites for the PV systems are characterized by good average renewable energy resource potential. In India, the annual average global solar radiation is about 5 kWh/m²/day and 2300-3200 sun-shine hours per year. The zone under investigation is located at 23°8' N latitude and 91°8' E longitude. The solar radiation data is taken from NASA surface meteorology and solar energy website [6]. Fig.3 shows the solar resource profile over year at the site. It has been observed that the average daily solar radiation ranges from 4.09 kWh/m²/day (September) to 5.59 kWh/m²/day (March) with scaled annual average 4.63 kWh/m²/day. Average clearness index ranges from 0.389 (July) to 0.637 (December).

II. Predicated results in simulation

A. PV power output

PV array power production over the year is shown in Fig.4. It is bell shaped curve and maximum power is obtained in noon time. It is found that average daily peak power ranges from 0.5 kW (July) to 0.82 kW (February) over the year. The mean output from the rated 1.2 kW_p PV system is 0.21 kW with mean daily output of 5.04 kWh.

B. Electricity production and consumption

The monthly energy production is shown in Fig.5. The PV array production and AC primary load consumption is 1840 kWh/yr and 1233 kWh/yr respectively. The excess electricity is found to be 390 kWh/yr (21.2%) whereas unmet electrical load is 66.2 kWh/yr (5.1%). Capacity shortage is found as 84.6 kWh/yr (6.5%). The capacity factor, hour of operation and maximum possible output are found to be 17.5%, 4404 hr/yr, 1.16 respectively. Fig.6 presents the correlation between PV power and available solar resource.

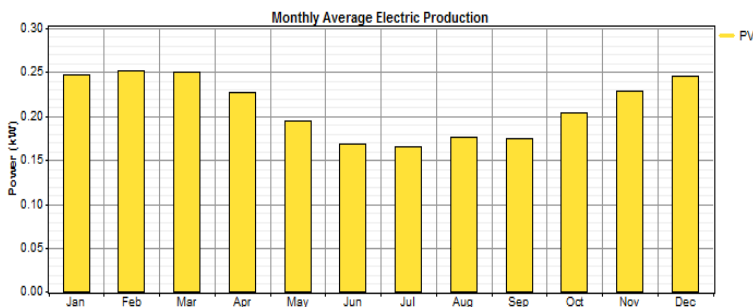

Figure 5. Monthly electric production

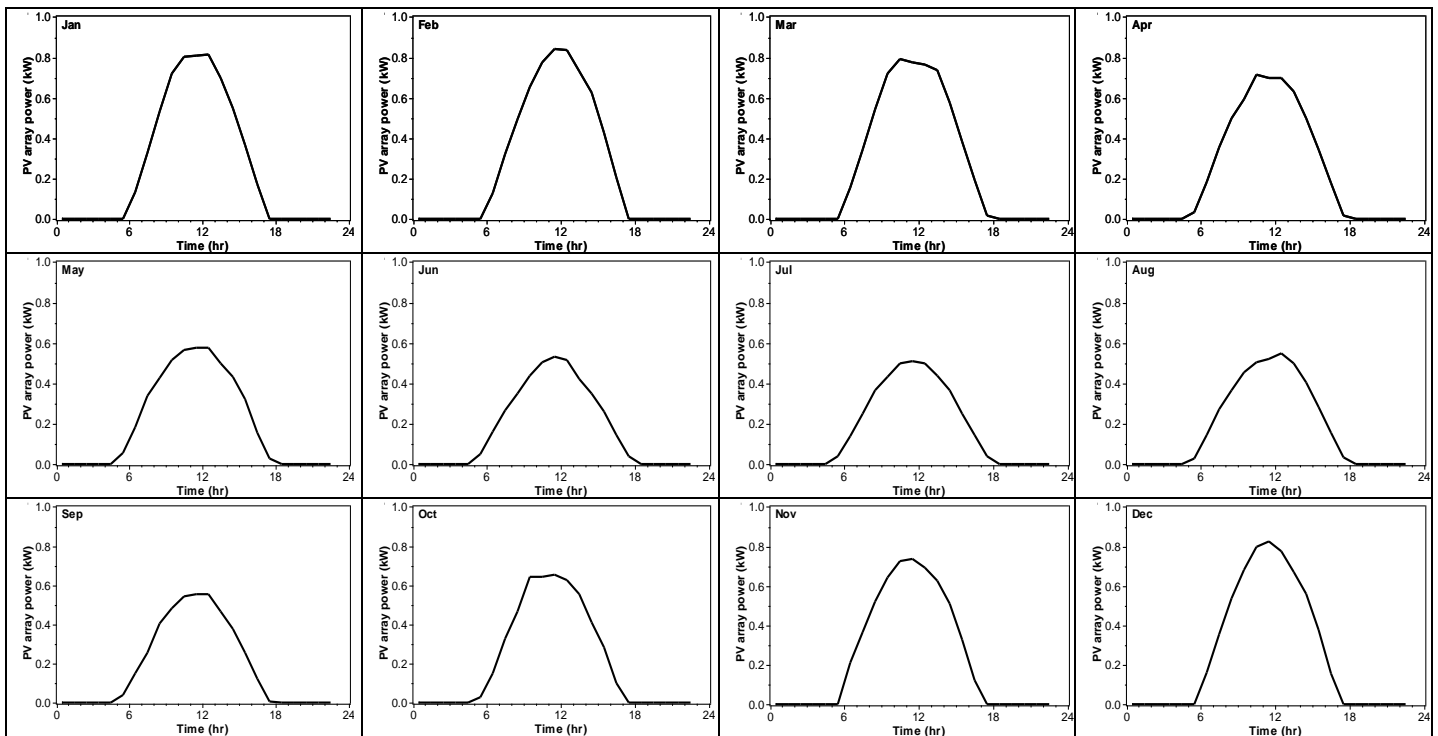

Figure 4. Daily power profile of the PV array over the year

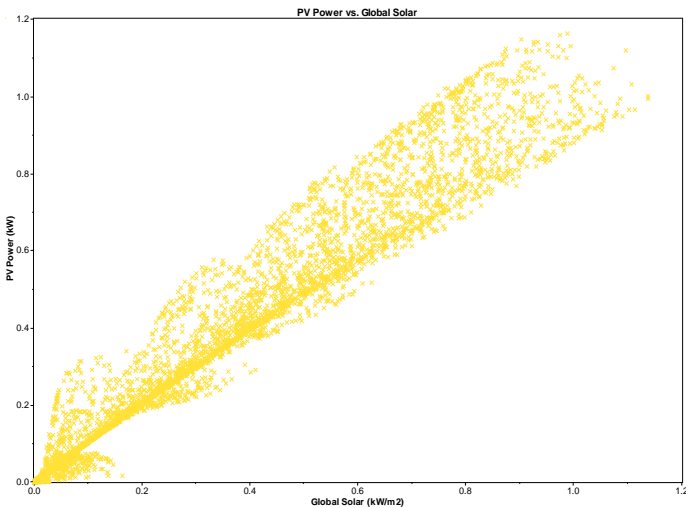

Figure 5. PV power vs. global solar radiation



Figure 6. 1.2 kW_p PV array at rooftop

TABLE II. PV PANEL SPECIFICATIONS

Module parameter	Value
Peak power	195 W _p
Open circuit voltage	45.5 V
Short circuit current	5.5 A
Peak power voltage	37.5 V
Peak power current	5.20 A
NOCT	47°C
Maximum system o/p voltage	1000V
o/p value	±3%
Module dimension	(1580 × 808 × 42) +/- 2 mm

III. Results with practical system

Fig.6 shows the 1.2 kW_p PV array installed at the rooftop of the institution. Six PV panels of 195 W_p each are connected in series which require 8 m² area in the rooftop of the building. Table II depicts the specifications of the PV panel.

The time interval T1 and T2 in Fig.7 to Fig.9 represent the time duration between 09:00-12:00 and 12:00-17:00 hours respectively. Fig.7 shows variation of load power and load current in a typical summer day. The load current varies between 13.82 - 13.48 A and load power ranges 0.66 - 0.70 kW. The PV array current and PV array power are shown in Fig.8. It is observed that PV power ranges between 0.18 kW (5:00 pm) to 0.72 kW (12:35 pm) with mean value of 0.37

kW. Average solar current is found to be 7.49 A. Battery discharging and charging current as shown in Fig.9 depends on the current consumed by the load and as well as the availability of PV current during that particular instant of time. As a result, the charging power of battery also varies. The results show that for summer the mean battery discharging current and charging current are 0.0045 A and 6.69 A respectively.

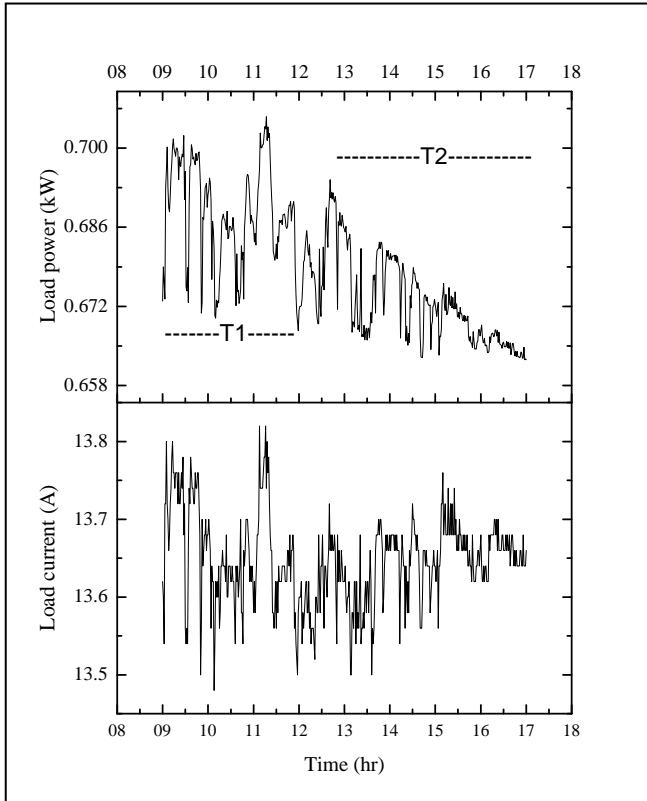

Figure 7. Load current and Load power

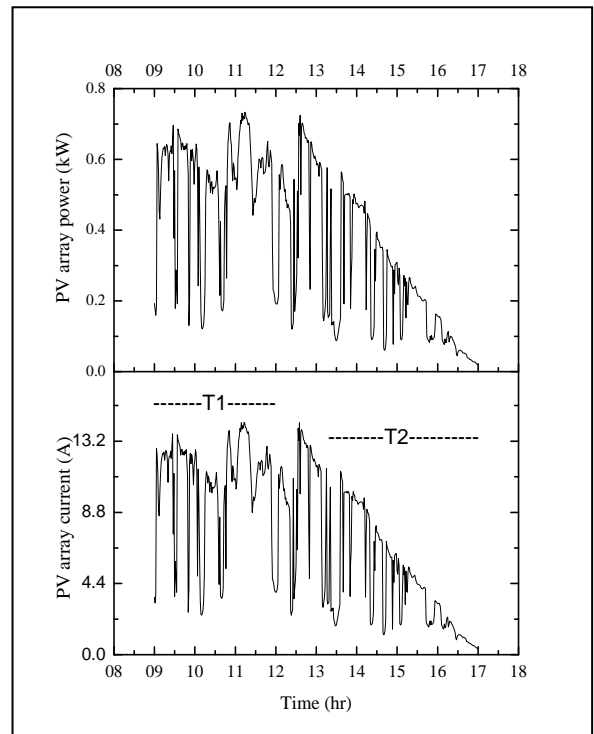

Figure 8. PV array power and current

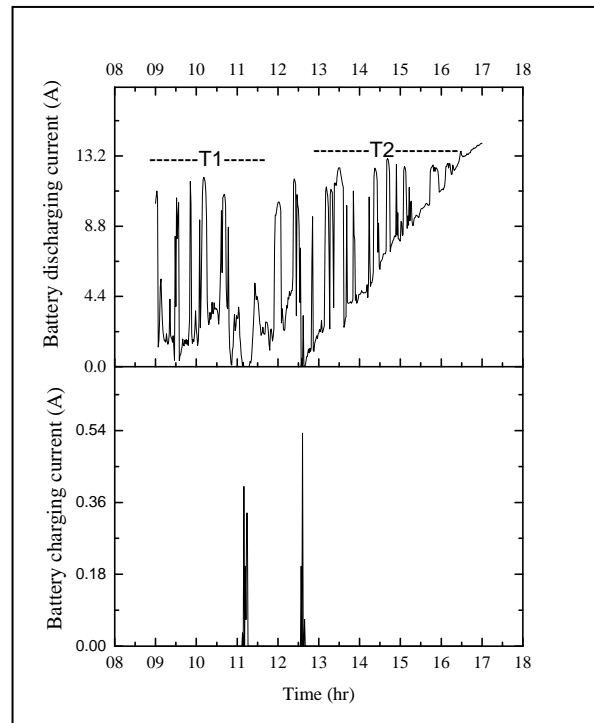

Figure 9. Battery charging and discharging current

IV. Conclusion

PV power generation is one of the promising options to continue sustainable development. This paper presents the predicted and few observed values of 1.2 kW_p PV system with constant loading condition. It is recorded that mean daily PV power is 0.37 kW for a typical summer day whereas predicted annual mean value is found to be 0.21 kW. From the simulation results, it is perceived that the plant is capable of producing 1840 kWh electricity annually.

Acknowledgment

Dr. Subhadeep Bhattacharjee thanks to the Ministry of Science of Technology (DST), Government of India for financial help for the project ‘Optimizing Power Output through Hybrid Technology’ under SERC Fast Track Scheme for Young Scientist.

References

- [1] M.M. El-Arini Mahdi, M. O. Ahmed, and F. Ahmed, “A new optimization approach for maximizing the photovoltaic panel power based on genetic algorithm and lagrange multiplier algorithm,” International Journal of Photoenergy, vol. 2013, pp.1-12, February 2013.
- [2] L.R. Brown, Chapter 9 of world on the edge: how to prevent environmental and economic collapse, Earth Policy Institute, 2011.
- [3] J. Byrne and L. Kurdgelashvili, “The role of policy in PV industry growth: past, present and future,” in Handbook of photovoltaic science and engineering, 2nd ed, USA: John Wiley & Sons, Ltd, 2011.
- [4] A. Colli and W. J. Zaaimam, “Maximum-power-based PV performance validation method: application to single-axis tracking and fixed-tilt c-Si systems in the Italian alpine region,” IEEE Journal of Photovoltaics, vol. 2, pp. 555-563, October 2012.
- [5] IEEE 1361™-2003 “Guideline for selection, charging, test, and evaluation of lead-acid batteries used in stand-alone photovoltaic (PV) systems.”
- [6] <https://eosweb.larc.nasa.gov/sse/>

About Authors:



Subhadeep Bhattacharjee received his BE (Electrical) from Tripura Engineering College (Presently NIT-Agartala), India in 2001, ME (Electrical) from Jadavpur University, India in 2003 and Ph.D (Engg.) also from Jadavpur University in 2009. Currently he is working as an Assistant Professor in Electrical Engineering Department of National Institute of Technology (NIT), Agartala and also rendering service as Faculty in charge of School of Energy Studies and Associate Dean (Administration) of the institution. He is a member of many professional societies like IEEE (USA), ISTE, IETE(I), IE(I), SES(I) and obtained C.Eng. from IE(I).

He has several publications in peer reviewed journals and conferences and contributor of many articles in various popular science magazines. He has authored a book ‘Energy and Power in North East India’ in 2010. His research interests include renewable energy, distributed power generation and hybrid power systems.



Shubhahsish Bhakta received his BE (Electrical) and M.Tech (Instrumentation) from National Institute of Technology (NIT), Agartala in 2009 and 2012 respectively. Currently he is a research scholar in the Department of Electrical Engineering at NIT-Agartala.