

A Systematic Strategy to Find the Natural Frequencies of an Industrial Robot

[Alaa Abdulhady Jaber; Robert Bicker]

Abstract—In order to design a reliable monitoring or control system for any machine, some characteristics of the machine have to be known, such as machine natural frequencies. In this paper, firstly static evaluation of the PUMA 560 robot, which has been used in this research study, when it is powered on, was accomplished. Then, the experimental modal analysis is performed to obtain the natural frequencies of the robot. Experimental modal analysis consist of: exciting the robot by hand held impact hammer, measuring frequency response function (FRF) between the excitation and a point on the robot, and then using software to find the natural frequencies. This analysis was conducted when the robot at four different configurations. Moreover, the explanation of the method and setup used for the experiments, which measurement equipment are used, and how FRFs are calculated will be presented in this paper. Finally, easy to follow strategy have been proposed to be used for modal analysis of different industrial robots.

Keywords—*industrial robot, frequency response analysis, natural frequencies*

I. Introduction

Modal analysis has been applied in many engineering disciplines, for instance, to diagnose faults in machines. Ma et al. successfully used experimental modal analysis for rotor fault detection of an induction motor [Ma et al., 2007]. The faults have been detected by monitoring the difference between the motor's vibration modes under normal and faulty conditions and at different load situations. Another research applied modal analysis approach for gearbox fault diagnosis [Liguo et al., 2009]. A simulation analysis was conducted using ANSY software. In the area of structural health monitoring (SHM), the modal analysis has been effectively used to study the effects of cracks in a structure on its natural frequencies [El-Kafrawy, 2011]. The researcher applied experimental and theoretical modal analysis to validate the results. Another application of modal analysis is in the field of industrial robots control. For instant, modal analysis of KUKA

type milling robot has been carried out by [Claudiu *et al.*, 2012]. The researchers tried to evaluate the robot stiffness at three different working configurations. The first step has been done in this research is the robot self-excited frequencies were identified using impact testing (modal analysis). Then, vibration analysis was conducted when the robot running, but does not perform the milling process. After that, vibration analysis has been done during the milling process. It has been concluded in this research that the robot configuration has a significant effect on its stiffness, and therefore on its natural frequencies. Moreover, Elosegui conducted an experimental modal analysis of a PUMA 560 robot [Elosegui, 1994]. The main aim of this analysis was to find the natural frequencies of the robot. A research group undertook a kinematic-kinetic and rigidity analysis of ABB-IRB 1400 robot [Karagulle *et al.*, 2012]. For robot modelling, SolidWorks software was used, and for robot rigidity analysis, ABAQUS software was implemented. In this research the robot's natural frequencies have been found theoretically and experimentally using modal analysis. By this study the researchers have managed to identify which is the most suitable bath for the robot to perform its task precisely. In this paper, an analysis of the robot when it is stationary will be carried out initially. The purpose of this analysis is to establish if there are any significant frequencies when the arm power on. After that, experimental modal testing will be applied to determine the natural frequencies of the robot. These frequencies can be used for robot condition monitoring and control as their values are subjected to change if a fault presents in the system. However, to get all the robot's natural frequencies, this test is accomplished when the robot at different configuration as will be explained later.

II. Used Robot General Overview

The PUMA 560 is a PC controlled arm robot, and it is used frequently in industrial applications. It is a serial manipulator with six revolute joints/degree of freedom (DOF). The PUMA 560 robot resembles the human arm in function. The robot's joints are named accordingly from 1 through 6: waist, shoulder, elbow, roll, pitch and flange, Fig. 1. Each of the robot's joints is controlled by a DC brushed permanent magnet servo motor. Additionally, electromagnetic brakes are equipped with the first three joints (waist, shoulder, and elbow), which lock the motors to prevent collapsing when the power is removed from the robot [Rutherford, 2012].

Alaa Abdulhady Jaber /Ph.D Student
School of Mechanical and Systems Engineering/ Newcastle University
United Kingdom

Robert Bicker /Senior Lecturer
School of Mechanical and Systems Engineering/ Newcastle University
United Kingdom

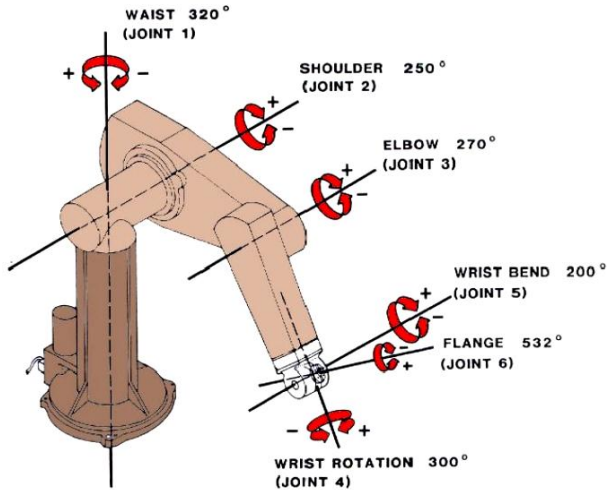

Figure 1. PUMA 560 Robot member representations [Rutherford, 2012]

III. Measuring Equipment and Experimental Set up

In the experiments, which will be explained later, measuring equipment provides all the required input and output data. To give a better understanding of the experiments, the measuring equipment will be described in this section. The measuring equipment consists of: an impact hammer, an accelerometer and a dynamic signal analyser.

A PCB integrated circuit piezoelectric (ICP) impact hammer model 086C03, which has its own built in charge amplifier, has been used. This hammer contains a force sensor mounted on its striking face to measure the hammer's response. By using the force sensor the impact force will be transferred into an electrical signal for analysis and display. Also, there is a threaded hole at the striking head of the hammer for a variety of impact tips (soft, medium, and hard). The main function of the tip is to transfer the force of the impact to the sensor, and also to protect sensor face from damage. Selecting the suitable tip type is very important for accurate analysis.

A single axis accelerometer type PCB 352C68, which has an integrated circuit piezoelectric (ICP) built in charge amplifier, has been used to measure the response from the robot in different axes (by mounting it on different axes). The amplifier in the accelerometer is directly fed from the signal analyser. Furthermore, this accelerometer has very good sensitivity (100 mv/g), so some experiments have been conducted in a quiet environment to avoid the effect of noise. The accelerometer was attached to the robot with a thin layer of super glue.

For data acquisition, the Data Physics Quattro, which is a vibration and sound analyser, has been used. This analyser offers 4 channels analog input up to 54 kHz, and can be connected to a laptop using USB 2.0. The analyser samples the voltage signals coming from the accelerometer or the force

transducer, and converts them to equivalent acceleration or force depending on the sensitivity information of the sensors. Additionally, for signal processing and analysing, the SignalCalc ACE software, which is especially designed to work with the Data Physics Quattro analyser, has been used. The experimental setup for this analysis is shown in Fig. 2. Moreover, the analysis herein has been carried out when the robot in four different configurations, where these configurations represent the standard configurations of this robot as shown in the Fig. 3.

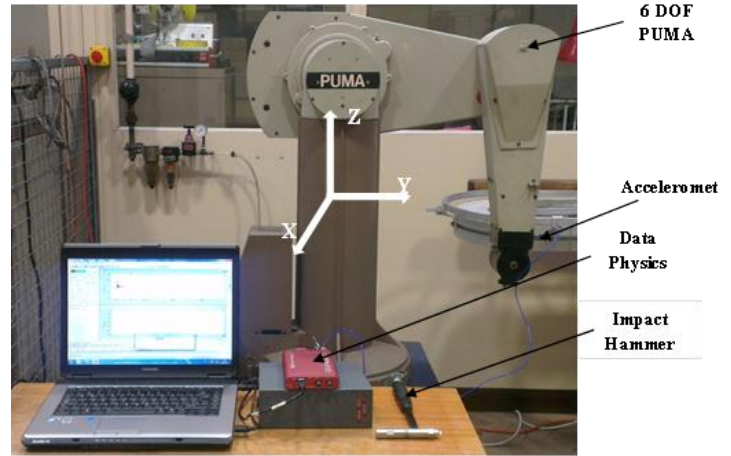

Figure 2. The experimental set up



Figure 3. The tested robot configurations

iv. Evaluation of Robot's Frequencies When it is Powered On

The control system, which maintaining the robot when it does not move, is operating in a fixed frequency and that will excite some mechanical frequencies of the robot. So, it is expected to see more dominate frequencies when the robot powered on than when it is powered off. However, it is worthwhile to know what the controller frequencies are to check if there are any significant frequencies with high amplitudes or not presented in the system.

To find the control system frequencies of PUMA robot, fast Fourier transform (FFT) analysis has been conducted. For this purpose, the vibration signal from the robot in the three axes and when it is at the configurations described above have been captured and analysed. The result of this analysis in X axis, and when the robot in configuration (1) is shown in the Fig.4. The frequency range has been taken up to 500 Hz to make sure all high frequencies (if present) are covered. Initially, this test has been accomplished when the robot's power off and secondly when it is powered on. The results for other configuration have been presented in Table 1.

Generally, arm robots are suffer from an inherent problem, which is gravity. However, even when the robot's power on and does not move, the joint's motors produce torques to hold the robot up against gravity. While, when its power is off, the brake system inside the motors lock them as explained previously.

From the figures and Table it can be observed that there is a noticeable difference between the frequency spectrum of the robot when its power off and on. It can be also noticed that not many frequencies present in the three directions when the robot arm powered on (maximum two frequencies). Additionally, the amplitudes associated with the excited frequencies are very low. Also, it can be clearly seen that in all four configurations just one frequency have been recorded in Y-direction. That must be strongly related to the dithering of the robot which is, as notice during doing the experiments, higher in X and Z- directions than Y-direction. Moreover, when the robot is extended vertically (configuration 4), just one mode have been excited in the three directions (X,Y,Z) because the robot's mass is acting through the robot's centre of mass so the robot is being conditionally stable.

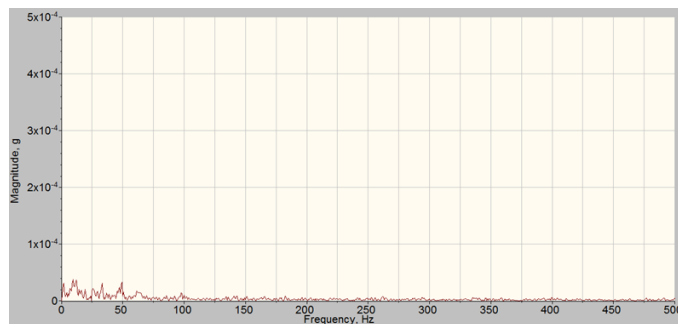

(A)The robot servo control oFF

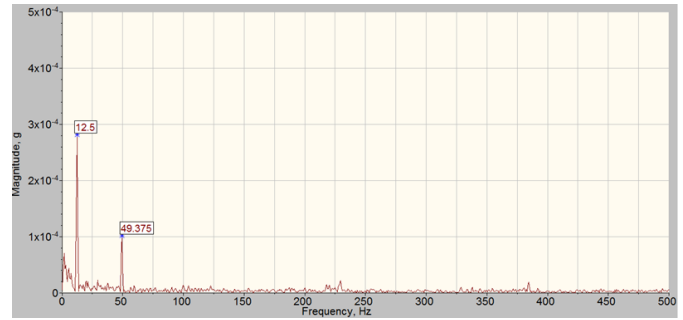

(B)The robot servo control oN

Figure 4. Frequency spectrum of the robot in X axis

TABLE I. THE FREQUENCY SPECTRUM OF THE ROBOT IN DIFFERENT AXES AND CONFIGURATIONS WHEN IT IS UNDER SERVO CONTROL

Configuration	Mode 1 (Hz)			Mode 2 (Hz)		
	X	Y	Z	X	Y	Z
1	12.5	12.5	30	49.37	-----	49.37
2	12.5	12.5	30	49.37	-----	-----
3	12.5	12.5	12.5	30	-----	30
4	12.5	12.5	49.75	-----	-----	-----

v. Frequency response function (FRF)

To find the self-excited frequencies of the PUMA robot, the frequency response function or modal analysis has been performed using impact testing. The main idea of this test is the robot will be excited in X, Y and Z directions using PCB integrated circuit piezoelectric (ICP) impact hammer (shown in Fig. 2), which has its own built in charge amplifier. Also, the hammer contains a force sensor inside to measure the impact force. The responses from the robot in the three axes have been captured using PCB accelerometer (the same accelerometer as in the previous test). Then, the time domain input $X(t)$ and response $Y(t)$ signals are transformed to frequency domain using fast Fourier transform (FFT). After that, the auto $S_{xx}(f)$ and cross $S_{yy}(f)$ power spectrum are calculated using frequency domain signals which are denoted as $X(f)$ and $Y(f)$, respectively [Bömer *et al.*, 2002].

$$S_{xx}(f) = \frac{1}{T} X^*(f)X(f) \quad (1)$$

$$S_{xy}(f) = \frac{1}{T} X^*(f)Y(f) \quad (2)$$

Where T is the measured time record, and X^* is the complex conjugate of $X(f)$.

Know after the auto and cross power spectrum have been found, the FRF, which is referred as $H_{(xy)}(f)$ can be estimated using following equation.

$$H_{xy}(f) = \frac{S_{xy}(f)}{S_{xx}(f)} \quad (3)$$

This analysis has been accomplished using the SignalCalc ACE software. However, the peaks of frequency response function correspond to the robot's natural frequencies. The amplitudes associated with the natural frequencies represent the energy required to excite these modes.

VI. Settings of SignalCalc ACE software for FRF measurement

The frequency resolution, which is coupled with the number of measurement lines, represents the first thing has to be set in the software. Higher frequency resolution means longer time, more data, and large data size. Thus, a compromise needs to be made. For this analysis, the number of lines has been set to 6400 lines. As a result, by using the following equations the frequency resolution (ΔF) can be determined by:

$$\Delta F = 2.56 * \frac{f_{max}}{N} \quad (4)$$

$$\Delta F = \frac{f_s}{N} \quad (5)$$

Where f_{max} is the maximum frequency, N is the number of lines, and f_s is the sampling frequency. The sampling frequency in **SignalCalc** software is always given by:

$$f_s = 2.56 * f_{max} \quad (6)$$

Additionally, to increase the accuracy of FRF measurement, the effects of random errors has to be reduced. These errors can be because of the contaminated noise or

induced by the person who is doing the experiments. However, averaging measurements represents a very useful method to get reliable results. Different types of averaging, such as peak hold, exponential, and stable, can be set up in the software. In this analysis a **stable** averaging method without overlap is used.

Another thing has to be set correctly is the trigger. Trigger indicates the source which initiates collection of data. However, many options can be set in the software, but the suitable choose for this analysis is the **input** option as the force from the impact hammer acts as input.

The leakage problem in the signals occurs when measured signals do not drop to zero within the measurement time interval. Therefore, to minimize the effects of leakage, the measured signals are multiplied by a window function before they are being transformed to the frequency domain. The software has different window types, but for transit signals the appropriate one is the **rectangular** window [DataPhysics, 2006]. Finally, the person doing the experiment has to ensure that the impact axis is parallel to the accelerometer axis, and also there is no double hit.

VII. Coherence

In the frequency function analysis, it is also wanted to identify where the best position to put the accelerometer on the robot is. Therefore, for data quality assessment, the coherence function can be used. Coherence functions (γ^2) shows how much the output is connected to the input on the frequency band inspected. Coherence has value ranges from zero to one, where a value of one corresponds to a perfect correlation between the impact and the output signal and there is no influence of noise. On the other hand, zero means no coherency. The coherence between the input and response signals can be calculated with the following formula [R.J.E.Merry, 2003]:

$$\gamma^2 = \frac{S_{xy}^2(f)}{S_{xx}(f) * S_{yy}(f)} \quad (7)$$

The coherence assessment has been done for three different accelerometer's locations which are the robot wrist, elbow, and shoulder as these locations contain the robot's gears. Also, it has been tried to put the accelerometer on the robot's links, but its links are hollow so noise percentage in the captured signal was high. Some of results of coherence function are shown in Fig. 5. Generally, if the robot is excited in a point located further from the sensor, the coherence will be very poor. Therefore, the point of impact has to be as close as possible to the accelerometer. Also, for selecting the best position to put the accelerometer not just the coherence has to be checked, but also the number of modes which can be excited by using that position. As a result, it is not accepted to choose the sensor location depending just on coherence, but largely can say that the accelerometer has to place near to the robot joints.

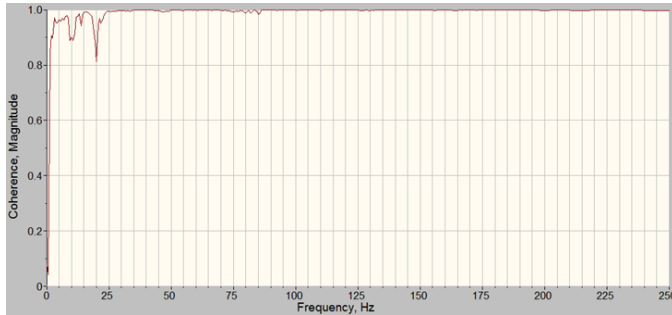

(A) The coherence when the accelerometer on the wrist

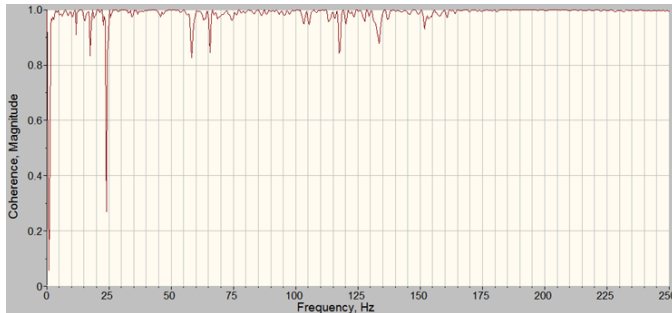

(B) The coherence when the accelerometer on the elbow

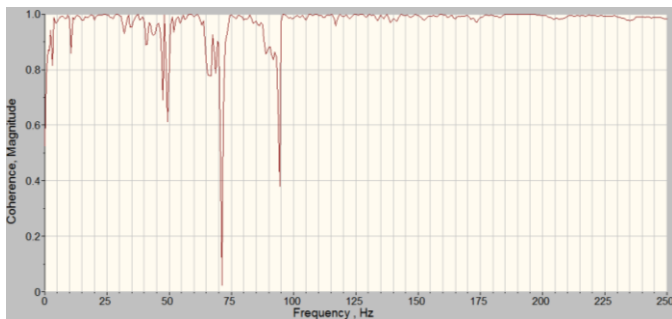

(C) The coherence when the accelerometer on the shoulder

Figure 5. The coherence function in x-direction when the accelerometer on different locations

VIII. The results of FRF analysis

Since the arm robots are configurable machines, they have different structural stiffness for different configuration. Consequently, some frequencies appear in one configuration and do not appear in another. Thus, the FRF analysis has been accomplished using four different configurations (as shown earlier), and three different accelerometer's positions have been used for signal capturing (wrist, elbow, and shoulder). It has been found that the number of modes which can be extracted from the FRF when the accelerometer on the shoulder not many so it is decided to be ignored. Higher frequencies can be excited in this test, but the higher frequencies are related to resonances of actual links and have an insignificant effect on the robot control [Elosegui, 1994, Claudiu *et al.*, 2012]. However, the emphasis will be on the lower frequency ranges. The Fig. 6 below shows the FRF results when the robot in configuration (1), and the accelerometer on the wrist.

Additionally, the frequency response analysis has been done when the accelerometer in different locations and the robot in different configurations. And, from the findings, it was noticed that there is some correlation between the excited modes when the accelerometer on the two previously identified positions. And also, it was noticed that the number of modes which have been captured when the accelerometer on the wrist are higher. As a result, the values of natural frequencies (modes) will be taken from the results when the accelerometer on the robot's wrist.

Moreover, to validate the results, the natural frequencies from another research, which used the same robot but different excitation method and configuration, have been utilized for comparison as shown in Table II.

The difference between the results may be because of the excitation method, the method of mounting the robot on the ground, and age of the robot. It has been observed from investigating the previous researches, which have been conducted in the area of robot modal analysis, that all of researchers have configured the robots in arbitrary positions, and extracted their natural frequencies. However, the disadvantages of that are: firstly not all the robot's natural frequencies will be extracted, these natural frequencies might be not accurate, and finally it will be difficult for other researchers to follow the used strategies to conduct modal analysis for any robot. Consequently, after doing this test, it can be said that the frequency response analysis can be undertaken easily by using the above procedure to find the natural frequencies of any robot.

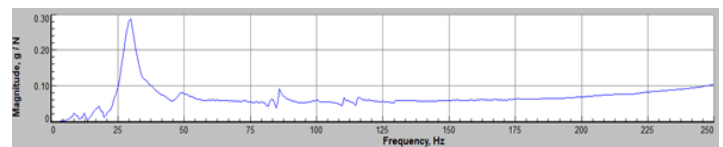

(A) X axis

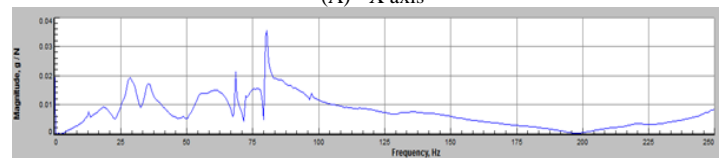

(B) Y axis

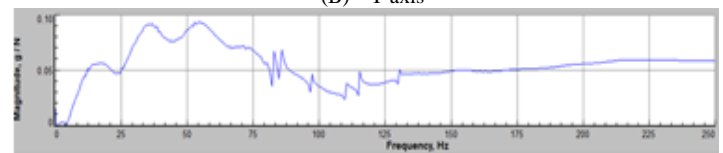

(C) Z axis

Figure 6. FRF of the robot in configuration 1

TABLE II. THE NATURAL FREQUENCIES FROM FRF ANALYSIS COMPARED WITH ANOTHER RESEARCH'S RESULTS

Mode	Present work Frequencies (Hz)	Frequencies of another paper[Elosegui, 1994] (Hz)
1	8.75	5.46
2	12.5	12.67
3	17.5	-----
4	20	20.12
5	25	25.23
6	30	-----
7	36.25	40.14
8	40.63	51.08
9	68.75	67.21
10	80	80.32
11	86.25	-----
16	197.5	158.69

ix. Conclusion

This paper has presented in its first section some literature about using frequencies response analysis for fault detection in deferent structures. Then, general overview of PUMA 560, which will be used in this research, has been introduced. After that, the used test equipment, the setup of the data acquisition software, and the theoretical background behind frequency response analysis have been explained. Firstly, the static analysis of the robot has been carried out, and it was found that few frequencies with very small amplitudes presented in the frequency spectrum of the robot when it was powered on. The robot natural frequencies have been obtained using frequency response analysis. The results were compared with another research study's result and showed acceptable correlation between them. These frequencies may be applied for robot fault detection or control.

References

- [1] BÖRNER, M., STRAKY, H., WEISPFENNING, T. & ISERMANN, R. 2002. Model based fault detection of vehicle suspension and hydraulic brake systems. *Mechatronics*, 12, 999-1010.
- [2] CLAUDIU, B., MEHDI, C., ALAIN, G. & JEAN-YVES, K. 2012. Dynamic behavior analysis for a six axis industrial machining robot.
- [3] DATAPHYSICS, C. 2006. *SignalCalc Dynamic Signal Analyzer User Manual* Data Physics Corporation
- [4] EL-KAFRAWY, A. 2011. Crack detection by modal analysis in 3D beams based on FEM. *International Journal of Mechanics and Materials in Design*, 7, 265-282.

- [5] ELOSEGUI, P. 1994. Measurement of the Dynamic Modael of a PUMA 560 Robot Using Experimental Modal Analysis. *Journal of Mechanical Design*, 116.
- [6] KARAGULLE, H., AMINDARI, A., AKDAG, M., MALGACA, L. & YAVUZ, Ş. 2012. Kinematic-kinetic-rigidity evaluation of a six axis robot performing a task. *International Journal of Advanced Robotic Systems*, 9.
- [7] LIGUO, Z., YUTIAN, W., SHENG, Z. & GUANGPU, H. The fault diagnosis of machine based on modal analysis. 2009. 738-741.
- [8] MA, H., LI, H., XIE, W. & CHEN, F. Vibration research on winding faults of induction motor based on experiment modal analysis method. 2007. 366-370.
- [9] R.J.E.MERRY 2003. Experimental modal analysis of H-drive
- [10] RUTHERFORD, J. 2012. Using The PUMA 560 Robot.

About Authors:



Alaa Abdulhady Jaber was born in Iraq in 1984. He received his B.Sc. and M.Sc. degrees in Mechanical Engineering from the University of Technology, Baghdad, in 2006 and 2008, respectively. He is now Ph.D. in Newcastle University/Uk.



Dr Robert Bicker is the head of the robotics group at the School of Mechanical and Systems Engineering in Newcastle University/UK. His research interests are the intelligent control of robotics and mobile robots, condition monitoring systems using intelligent approaches, and mechatronics in medical applications.