

Multiple antennas for Underground-to-Aboveground Communication in Wireless Underground Sensor Networks

Tanawat Dangdragool, Chatchai Khunboa, Wasu Chaopanon
Department of Computer Engineering
Khon Kaen University
Khon Kaen, Thailand, 40002

Abstract— Receive Signal Strength Indicator (RSSI) is one of performance metrics in wireless communications. The value indicates whether receiver could receive a packet. Since signal can reflex and refract from soil surface, underground nodes may not be able to communicate with aboveground nodes. One way solving this problem is to control the antenna orientation where antenna's radiation pattern is in an appropriate direction.

Therefore, in this work, we develop two types of sensor nodes which are 2-and 3-antenna nodes to improve RSSI values for underground-to-aboveground communications. Results show RSSI values of 2-and 3- antenna have better than those of 1-antenna sensor node approximately 0.85 and 1.43 dBm for manual installation and 2.64 and 6.97 dBm for random installation respectively.

Keywords—Multiple antennas, Wireless Underground Sensor Networks, Antenna orientation

I. Introduction

Wireless Underground Sensor Networks (WUSN) [1] is communication between sensor nodes through the soil from the air-to-underground or underground-to-underground, WUSN is suitable for many applications as follows,

- agriculture applications such as moisture monitoring and temperature measurement.
- disaster applications such as earthquake and landslide monitoring.
- Security applications such as intrusion movement detection from sound, vibration.

However, a regular sensor node has poor communication efficiency because many factors in soil [2, 3, 5, 6] such as moisture, burial depth, density and antenna orientation between sensor nodes affects signal attenuation.

In this paper, we develop two types of sensor nodes which are aimed to improve their communication by using multiple antennas. Each antenna has a 90 degree angle. We use Received Signal Strength Indicator (RSSI) as the performance metrics for each sensor node. Results of experiments show the RSSI values of 2- and 3-antenna nodes compared with regular node for manual and random node's placement for

underground-to-aboveground communication at the 868 MHz frequency. We measure efficiency from RSSI which is power level of received signal. Therefore, higher RSSI that is the strong signal.

The rest of this paper is organized as follows: Section II is the overview of related work. In Section III, the methodology used in experiment is described including our sensor nodes and software used. The results for underground-to-aboveground communication in the manual and random placement of each sensor node are presented in Section IV. Finally, the conclusion of our work is presented in Section V.

II. Related Work

In [3], Silva and Vuran separate WUSN into three communications: underground-to-underground, underground-to-aboveground and aboveground-to-underground. They also present concept for experimental methods and discuss factors effect underground transmission such as antenna orientation, burial depth, inter-node distance, temporal characteristics and moisture. In [4,5], results of their experiment are presented using Mica2 at 433 MHz frequency.

In [6], they present experimental results at frequency 869 MHz underground to aboveground communication at real environment conditions for measuring signal attenuation of each distance, burial depth and moisture. Results show high soil moisture affect high signal attenuation and error rate.

Results of the experiment at frequency 2.4 GHz is shown in [7]. The experiment shows the efficiency and error rate from measuring receive signal strength indicator (RSSI) between aboveground and underground communication links. Results show that at frequency 2.4 GHz, a sensor node has a poor transmission efficiency and a short communication distance.

Multiple antennas can solve the problem of antenna orientation shown in [8]. This work compares an accuracy of sensor node's location by using one and two antennas. Results show the sensor node with two antennas more accuracy than the sensor node with an antenna.

III. Experiments Setup

Our experiment present underground to aboveground communication as shown in Figure 1. A sender node is buried 25 cm-depth underground. The receiver node is elevated a distance of 1 m off the ground where we increase its location horizontally from 1 to 10 m. Then, we let the sender node transmits 500 packets to the receiver and average packet's.

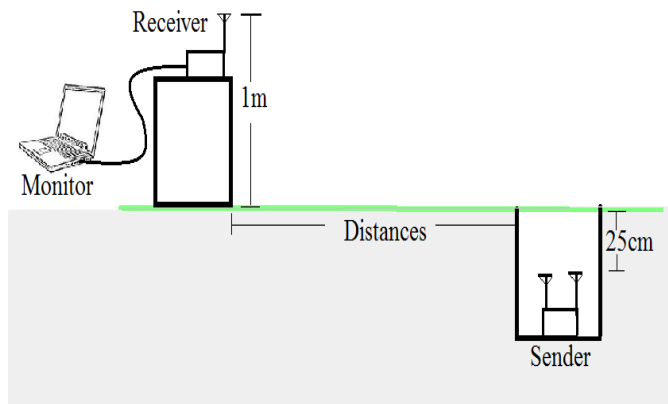

Figure 1. Experiments setup.

A. Environment

We test all sensor nodes in real environment at Khon Kaen University. The excavated area consists of soil about 85%, loose rock about 10% and other about 5% such as grass, broken glass, dry soil and a few stones.

B. Hardware Design

We choose system-on-chip (SOC) CC430 [9] from Texas Instrument which consists of a MSP430 microcontroller and a CC1101 transceiver at 868 MHz frequency. Its maximum data rate is up to 250 kbaud and it can support many protocols such as DASH7, 6LoWPAN, Wireless M-Bus stack, Diversity Path Mesh and SimpliciTI.

The Block diagram of our sensor node is shown in Figure 2. Instead of directly connect to an antenna, the transceiver connects to a RF switch to support multiple antennas usage. Figure 3 shows a regular sensor node (1-antenna) from Texas Instrument and our 2-and 3-antenna sensor nodes. For our nodes, each antenna is a 90 degree angle of others. All sensor nodes use the same antennas which provoid 2.5 dBm gain. All sensor nodes use two AA batteries for their power supply.

IV. Experiment Results

Our experiment is designed to measure RSSI values of each packet where the sender node is manual setting and random setting. To accomplish this, we use simpliciTI protocol[10] to generate 500 packets at 250 kbps data rate. All sender are set output power at 0 dBm. For the receiver node, we connect to MSP-FET430UIF and use SmartRF software to capture all packet and calculate average RSSI values

Figure 4 shows the results of all sensor nodes: single antenna, 2-antenna and 3-antenna. For the 2-antenna sensor node, one antenna is in the horizontal (0°) direction and another is in the vertical (90°) direction with surface ground. For the 3-antenna sensor node, the antenna is in x-y-z axes where z-axis is in the vertical direction with surface ground. For single antenna, two directions are measured in the horizontal and vertical directions with surface soil.

Results show 2-antenna and 3-antenna sensor nodes have no significant difference in the RSSI values. The 3-antenna sensor node has the best RSSI values almost all ranges. Moreover, the 3-antenna's average RSSI values are higher than 1-antenna's value about 1.43 dBm in horizontal direction. They are also higher than 2-antenna's average RSSI values about 0.85 dBm. Since the radiation pattern is pointed along the ground direction, the 1-antenna's average RSSI of vertical direction values are the worse.

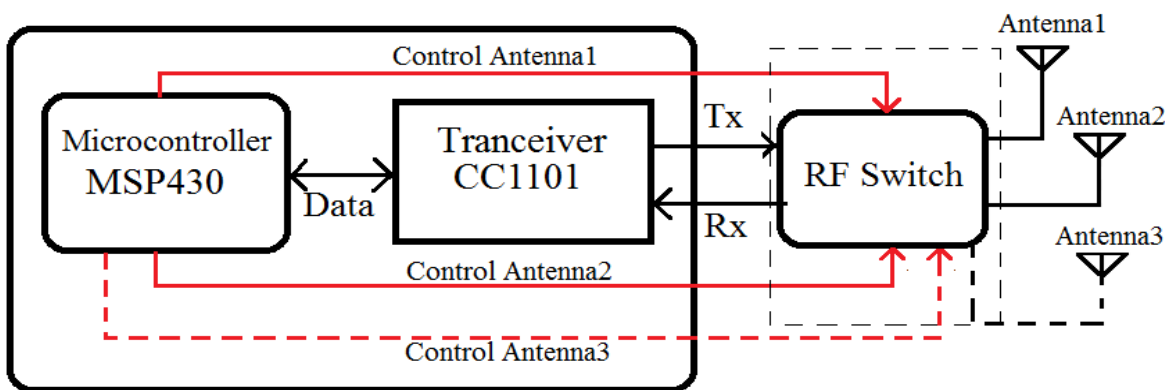

Figure 2. Our sensor node diagram



Figure 3. a) Regular sensor node b) Two-antenna node c) Three-antenna node

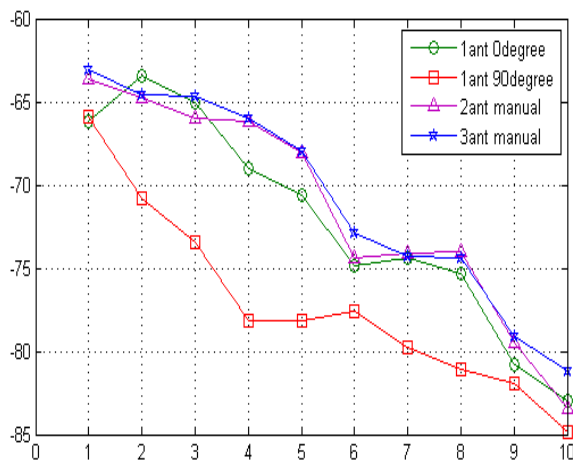

Figure 4. Results of manual installation

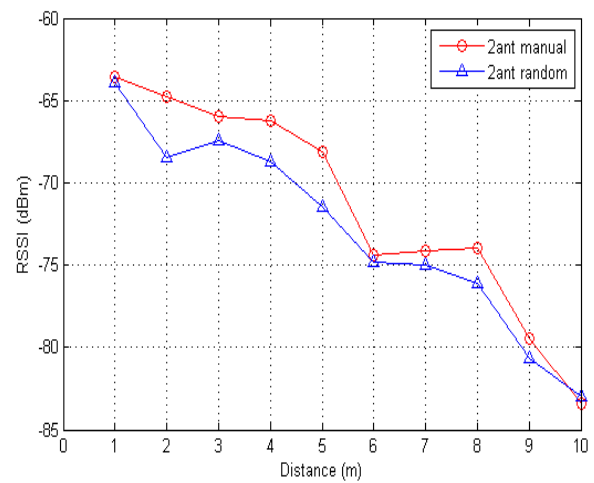

Figure 6. Random installation of two-antennas node

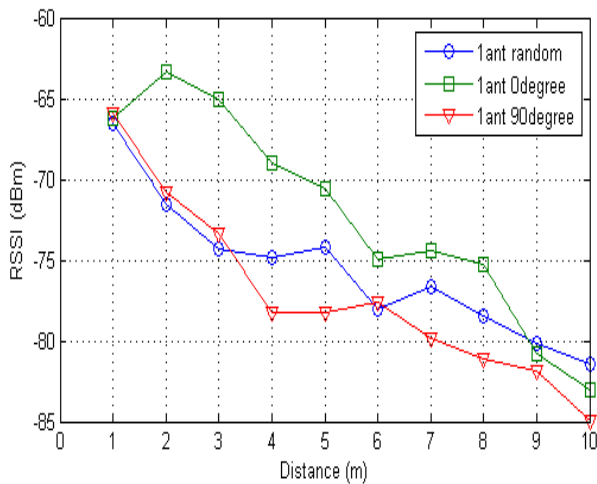

Figure 5. Random installation of single antenna node

Figure 5 shows the comparison of manual and random placements of the sensor node. Testing shows that the RSSI values of the random placement could be higher than those of fixed placement in some cases if a proper antenna's direction is happened. However, the average RSSI value of random placement is in between the fixed placements.

Figures 6 and 7 also compares the RSSI values of 2-and 3-antenna cases respectively. In the 2-antenna sensor node, all RSSI values of the manual placement are about 1.55 dBm better. In the 3-antenna sensor node, because there are three antennas installed, more opportunity of antenna's radiation pattern is pointed to the receiver. Thus, random installation is better than fix direction installation about 2.2 dBm.

Finally, all random installation are compared as shown in Figure 8. The 3-antenna is the best average RSSI value. Moreover, the average RSSI value of 3-antenna node have higher than those of 1-antenna and 2-antenna about 6.97 and 4.33 dBm respectively.

v. Conclusions

Multiple antennas present a solution of node's long-term deployment of WUSN. In this study, we concentrate on the random placement of nodes in order to support underground-to-aboveground communications. The experiment results show 3-antenna provide the best average RSSI value which the value of 3-antenna is higher than those of 1-antenna and 2-antenna nodes about 6.97 dBm and 4.33 dBm. Therefore, our node should be capable of using in a practical underground sensing application.

References

- [1] I. F. Akyildiz and E. P. Stuntebeck, "Wireless underground sensor networks: Research challenges," *Ad Hoc Networks Journal* (Elsevier), vol. 4, pp. 669-686, July 2006.
- [2] S.-U. Yoon, L. Cheng, E. Ghazanfari, S. Pamukcu and M. T. Suleiman, "A Radio Propagation Model for Wireless Underground Sensor Networks", in *Global Telecommunications Conference (GLOBECOM 2011)*, 2011 IEEE, 2011, p. 1-5.
- [3] A. R. Silva and M. C. Vuran, "Development of a testbed for wireless underground sensor networks", *EURASIP J. Wirel. Commun. Netw.*, 2010, p. 9:1-9:12, 2010.
- [4] A. R. Silva and M. C. Vuran, "Empirical Evaluation of Wireless Underground-to-Underground Communication in Wireless Underground Sensor Networks", in *Proceedings of the 5th IEEE International Conference on Distributed Computing in Sensor Systems*, Berlin, Heidelberg, 2009, p. 231-244.
- [5] A. R. Silva and M. C. Vuran, "Communication with Aboveground Devices in Wireless Underground Sensor Networks: An Empirical Study", in *Communications (ICC)*, 2010 IEEE International Conference on, 2010, p. 1-6.
- [6] J. Tiusanen, "Wireless Soil Scout prototype radio signal reception compared to the attenuation model", *Precision Agriculture*, 10, vol. 5, p. 372-381, 2009.
- [7] E. P. Stuntebeck, D. Pompili and T. Melodia, "Wireless underground sensor networks using commodity terrestrial motes", in *Wireless Mesh Networks, 2006. WiMesh 2006. 2nd IEEE Workshop on*, 2006, p. 112-114.
- [8] L. Wei, N. Liu, Y. Pang, Q. Wang and X. Liu, "Application of antenna diversity technique on Wireless Sensor Network localization", in *Control and Decision Conference (CCDC)*, 2010 Chinese, 2010, p. 1412-1416.
- [9] CC430 datasheet. Texas Instruments, Inc. [Online]. Available : <http://www.ti.com/lit/ds/slas554f/slas554f.pdf>
- [10] SimpliciTI Sample Application User's Guide. Texas Instruments, Inc. San Diego, CA, USA. [Online]. Available : <http://www.cs.washington.edu/education/courses/cse466/10au/pdfs/SimpliciTI%20docs/SimpliciTI%20Sample%20Application%20User's%20Guide.pdf>

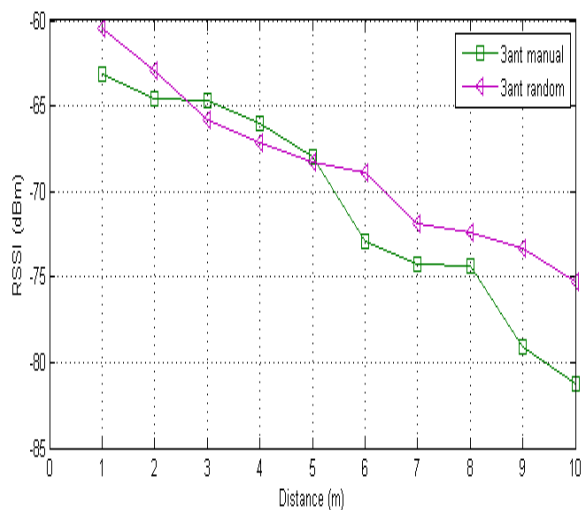

Figure 7. Random installation of three-antennas node

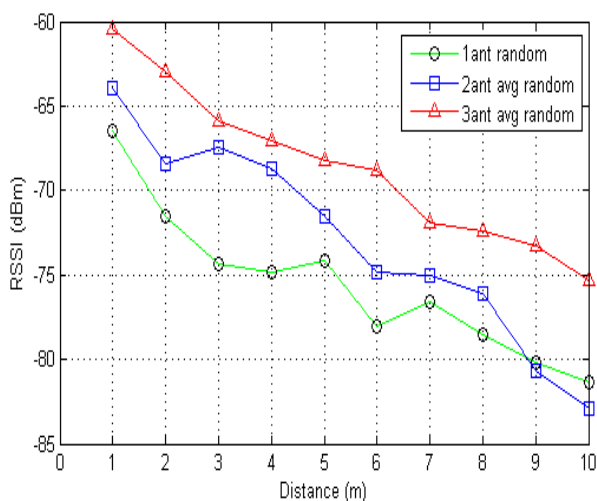

Figure 8. Random installation of three nodes