

# A Comparative Analysis of Fused Neuro-Fuzzy Systems

Rashmi Kumari<sup>1</sup>, Md. Rashid Ansari<sup>2</sup>  
ECE Deptt., Galgotias University  
Greater Noida, U. P.

Dr. S. K. Aggarwal  
ECE Deptt., JJT University  
Jhunjhunu, Rajasthan

**Abstract**— Fusion of ANN and Fuzzy Inference System (FIS) are frequently applied by researchers in various scientific and engineering research areas to solve real world problems. This type of system is characterized by a fuzzy system where fuzzy sets and fuzzy rules are adjusted using input output pattern pair. There are several methods of integration of these two powerful computing techniques that is basically application dependent. This paper describes the structural differences of several popular combinations of ANN and FIS along with its advantages and disadvantages

**Keywords**—Fuzzy inferencing system, Concurrent model, Co-operative model, Neuro-Fuzzy architectures.

## I. INTRODUCTION

Neuro-Fuzzy computing has drawn the attention of several researchers of various fields for solving real world complex problems. These two techniques neural networks and fuzzy logic are applied many times together where the classic techniques are not sufficient to produce an easy and accurate solution. ANN learns the presented inputs by updating the interconnections between layers of neurons. There is need to specify the architecture and learning algorithm for construction of ANN for any application. Similarly for fuzzy inferencing system (FIS), there is need to specify the fuzzy sets, fuzzy operators and knowledge base.

The term neuro-fuzzy was born by fusing of these two paradigms. Researchers used to combine these tools in different way, so that sometimes confusion created on the exact way of working of neuro-fuzzy systems. We can define the neuro-fuzzy term in general, as a type of system characterized for a similar structure of fuzzy controller where the fuzzy sets and rules are adjusted using neural network techniques in iterative manner with the set of pair of input and output data vectors. This kind of system behaves like a neural network first where learning of parameters occurs and at the time of execution it behaves like a fuzzy system. However, both techniques have some advantages as well as disadvantages too individually. But when they mixed together results are better than the each isolated techniques.

The combination of FIS and ANN can be classified into three categories as:

(a) Concurrent Neuro-Fuzzy model

(b) Cooperative Neuro-Fuzzy model

(c) Fully Fused Neuro-Fuzzy model

This paper describes the above mentioned model along with their advantages and disadvantages and further focuses on different types of fused neuro-fuzzy systems such as FALCON, GARIC, NEFCON, FUN, SONFIN and ANFIS. This paper is organized in this way that the section II and section III describes the concurrent neuro-fuzzy model and cooperative neuro-fuzzy model respectively, section IV gives the complete description of architecture of all fused model, section V contains the discussion on advantages and disadvantages of fused models and section VI is the conclusion of the neuro fuzzy models.

## II. CONCURRENT NEURO-FUZZY MODEL

In the concurrent model the neural network and the fuzzy systems work together continuously to determine the required parameters specially if the input variables of the controller cannot be measured directly. This combination is not to optimize the fuzzy system but only aids to improve the performance of the overall system. While learning takes place in neural network, the fuzzy system is remain unchanged during this time.

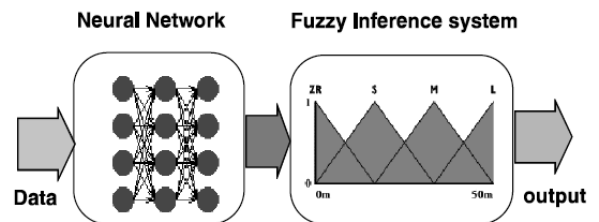

Figure 1. Concurrent neuro-fuzzy model

Generally, neural network preprocesses the inputs of the fuzzy system but in some cases if the fuzzy output are not

directly applicable to the process, the neural network can be used as a postprocessor of FIS outputs.

### III. COOPERATIVE NEURO-FUZZY MODEL

A cooperative model can be considered as a preprocessor wherein the artificial learning mechanism determines the fuzzy inference system (FIS) membership functions or fuzzy rules from the training data. There is no role of ANN after determination of FIS. The rules are generally formed by fuzzy clustering algorithms. ANN is used to approximate the fuzzy membership functions from the training data.

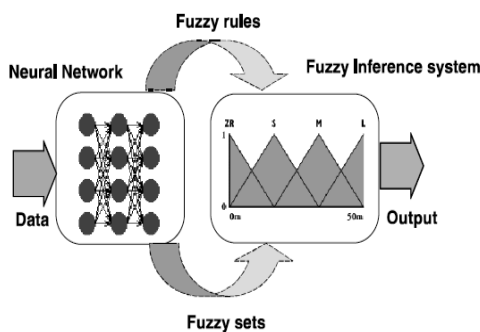

Figure 2. Cooperative neuro-fuzzy model

### IV. FULLY FUSED NEURO-FUZZY MODEL

In fully fused neuro-fuzzy model, neural network learning algorithms are used to determine the parameters of fuzzy inference system. Fused neuro fuzzy systems share data structures and knowledge representations. The conventional learning algorithm such as gradient descent cannot be applied directly to fused systems as the functions used in the inference process are usually non-differentiable. Hence, in fused neuro fuzzy systems learning algorithm applied to a fuzzy system is designed for special ANN like structure by using differentiable function in the inference system or by not using the standard neural learning algorithm.

There are several models proposed by researchers which seem similar in essence, but they are having basic differences. Representation through a neural network is more convenient because it allows visualizing the flow of data through the system and the error signals that are used to update its parameters. This benefit allows us to compare the different models or to visualize structural differences. Some of the important models are as: FALCON, GARIC, ANFIS, NEFCON, FUN, SONFIN, EFuNN, evolutionary design of neuro-fuzzy systems etc.

#### A. Fuzzy Adaptive Learning Control Network (FALCON)

FALCON has a five layered architecture as shown in figure 3. There are two linguistic nodes for each output in which one node is for the storing of pattern data and the other is for the real output of the FALCON. The first hidden layer is responsible for the mapping of the input variables relatively to each membership functions i.e. fuzzifications. Each node can be either a single node representing a simple membership function or multilayer nodes for a complex membership functions. The second hidden layer defines the antecedents of the rules followed by the consequents in the third hidden layer.

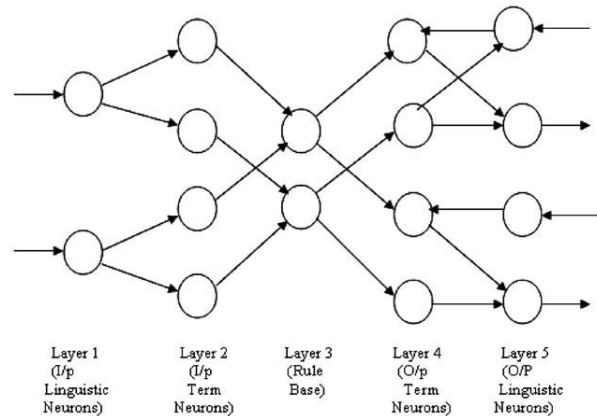

Figure 3. Architecture of FALCON[14]

To locate the initial membership functions and initial rule base unsupervised learning algorithm is used and a gradient descent learning algorithm is used to optimally update the parameters of the membership functions to produce the desired output.

The hybrid learning basically occurs in two different phases. In the first phase the centre and the width of the membership functions are determined by self organized learning technique. After determination of initial parameters, the formulation of antecedent rules becomes easy. A competitive learning algorithm is used to determine the correct rule consequent links of each rule node. The whole network is framed after the establishing of the fuzzy rule base. In the second learning phase the parameters of the membership function are adjusted optimally. Generally the backpropagation algorithm is used for the supervised learning. Hence FALCON provides a framework for structure and parameter adaptation for designing neuro-fuzzy system.

#### B. Generalized Approximate Reasoning Based Intelligent Control (GARIC)

GARIC implements a neuro-fuzzy controller by using two neural network modules. It consists of an Action State Evaluation Network (ASN) and an Action Selection Network (ASN). The AEN assesses activities of the ASN. The ASN is a feedforward network with five layers with no connection weights between layers but the learning process modifies parameters stored within the network. Architecture of ASN of GARIC is shown in figure 4.

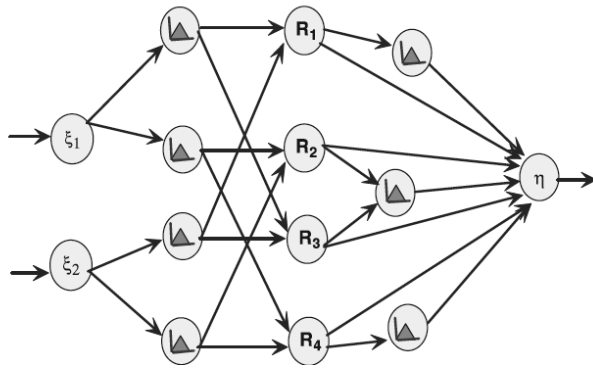

Figure 4. Architecture of ASN

The first hidden layer stores the linguistic values of all the input variables. Each input can only connect to the first layer, which represents its associated linguistic values. The fuzzy rule base are stored in the second hidden layer. The third hidden layer represents the linguistic values of the control output variable. The mean of maximum method of defuzzification is used to compute the rule outputs in GARIC. Thus the conclusions should be transformed from fuzzy values for numerical values before being accumulated in the final output of the controller. The learning method used in GARIC is a combination of gradient descent and reinforcement learning.

C. Neuro-Fuzzy Controller (NEFCON)

The Neural Fuzzy Controller (NEFCON) is designed to implement Mamdani type fuzzy inference system as shown in figure 5. The connections in this architecture are weighted with fuzzy sets and rules using the same antecedents so called shared weights. These weighted connections assure the unity of the base of the rule.

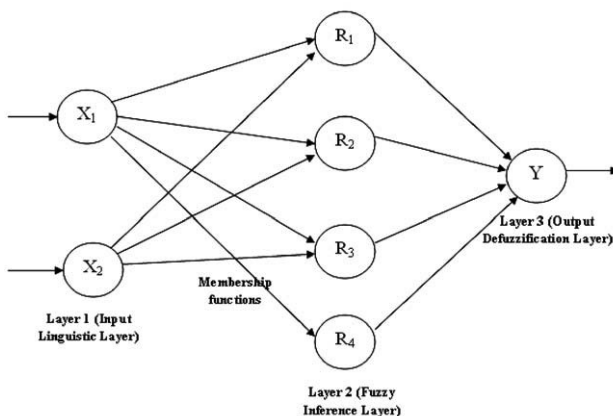

Figure 5. Architecture of NEFCON

There are three layers in NEFCON architecture in which input units present the linguistic values and output unit is defuzzification process. The intermediate hidden layer

represents the fuzzy inference logic. The learning technique of the NEFCON is a combination of backpropagation and reinforcement learning.

This architecture can be used to learn the rule base the rule base from the beginning, if no prior knowledge about the system is available or even to optimize an initial manually defined rule base. NEFCON has two available variants, one is NEFPROX that is used for function approximation and another one is NEFCCLASS that is used for classification tasks.

D. Fuzzy Net (FUN)

The architecture of fuzzy net consists of an input, an output and three hidden layers as shown in figure 6. The neurons of each layer have different activation functions representing the different stages in the calculation of fuzzy inference. The input variables are stored in the input neurons. The neurons in the first hidden layer fuzzify the input variables and also contain the membership functions. In the second hidden layer, fuzzy conjunctions (AND operator) are calculated. Membership functions of the output variables are stored in the third hidden layer. Activation function for this layer is Fuzzy- OR. The output neuron contains the the output variables where defuzzification performs by using an appropriate defuzzification process. The given rule is depicting the architecture of FUN.

Rule : IF ( Goal is forward AND sensor is near) OR ( Goal is right AND sensor is far) THEN steering= forward.

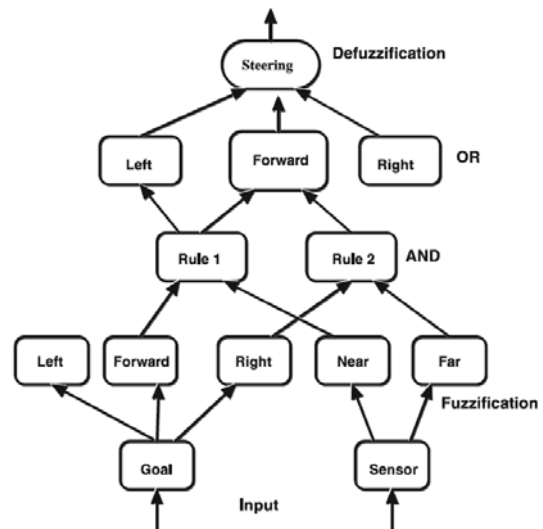

Figure 6. Architecture of FUN

The rule and membership functions are used to construct an initial FUN network. The parameters of the membership functions are altered by using a learning procedure or by changing the structure of net or the data in the neurons. For learning of the rules the connections between fuzzy rules and fuzzy values are changed. Membership functions are learned

by changing the data of the nodes in the first and three hidden layers. Training of FUN can be done by standard neural network training strategies such as reinforcement and supervised learning.

E. Architecture of SONFIN

Self Constructing Neural Fuzzy Inference Network (SONFIN) implements a Takagi- Sugeno type fuzzy inference system. It has six layered architecture as shown in figure 7. Fuzzy rules are created and adapted as online learning proceeds via a simultaneous structure and parameter identification.

The input space is partitioned in a flexible way according to an aligned clustering based algorithm. To identify the consequent part, a singleton value is selected by a clustering method and is assigned to each rule initially. Later on, some additional significant terms ( input variables) selected via a projection based correlation measure for each rule will be added to the consequent part incrementally as learning proceeds. For parameter identification, the consequent parameters are tuned optimally by either least square or recursive least square algorithm and the preconditions parameters are tuned by backpropagation algorithm. SONFIN can be used for normal operation at any time during the learning process without repeated training or the input output pattern when online operation is required.

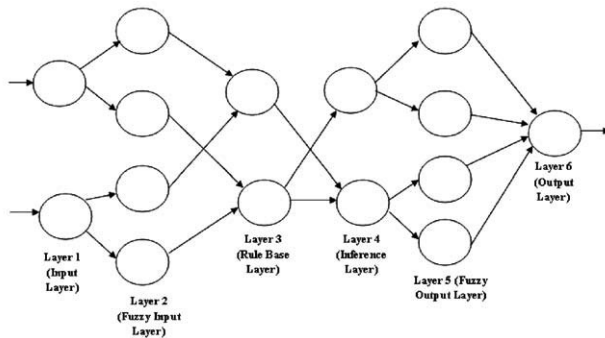

Figure 7. Architecture of SONFIN [14]

F. Adaptive Neuro Fuzzy Inference System (ANFIS)

Adaptive Neuro Fuzzy Inference System (ANFIS) consists of a five layered architecture as shown in figure 8. ANFIS implements a Takagi -Sugeno FIS. The input variables are fuzzified in first hidden layer and the fuzzy operators (T-norm) are applied in the second hidden layer to compute the rule antecedent part. The third layer normalizes the rule strengths or fuzzy rule base and the consequent parameters are determined in the fourth layer. The output layer calculates the final output as the summation of all the incoming input signals. Backpropagation learning method is used to determine

the input membership parameters and for determination of consequent parameters, least mean square method is used.

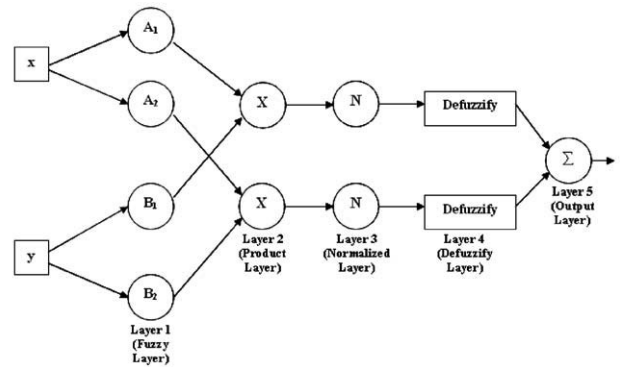

Figure 8. Architecture of ANFIS

In ANFIS, the learning process is only concerned with parameter level adaptation within fixed structures. To determine the optimal premise-consequent structures, rule numbers etc is very complicated for large scale problems. The structure of ANFIS assures that each linguistic term is represented by only one fuzzy set.

G. Evolutionary Design of Neuro- Fuzzy System

In the process of evolutionary design of neuro-fuzzy systems, the node parameters, architecture, and learning parameters are adjusted according to five tier hierarchical evolutionary search procedures. This model can adapt to Mamdani or Sugeno type fuzzy inference system. The basic layered architecture is as shown in figure 9. The evolutionary search process will resolve the optimal type nad quantity of nodes and connection between layers.

Function of the fuzzification layer and the rule antecedent are similar as that of other neuro fuzzy models. Inference system determines the consequent part of the rules, which will be adapted accordingly by the evolutionary search mechanism. Aggregation operators will also be adapted according to the FIS chosen by the evolutionary algorithm.

For every learning parameters and every inference mechanism, there is the global search of inference mechanism that continues on a faster time scale in an environment decided by the learning parameters, inference system and the problem. Similarly for every architecture, evolution of membership function proceed at a faster rate in an environment decided by the architecture , inference mechanism, learning rule, type of inference system and the problem. If there is more prior knowledge of architecture than the inference system, implementation of architecture at higher level will be much better.

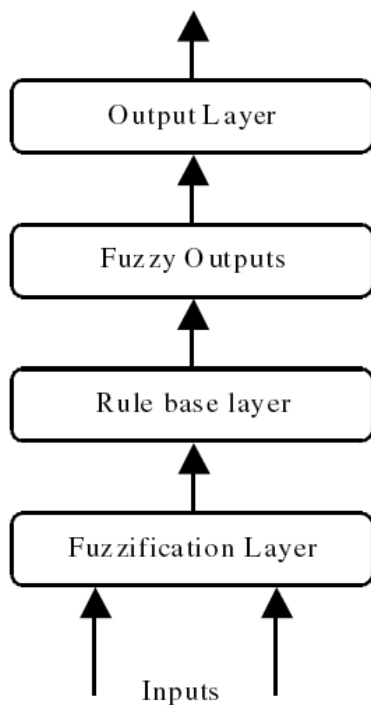

Figure 9. Architecture of Evolutionary design of NF system

## V. DISCUSSION

The concurrent and cooperative model are not fully interpretable due to the presence of artificial neural network whereas the fully fused neuro fuzzy model is interpretable and capable of learning in a supervised way. The learning process of FALCON, GARIC, ANFIS, NEFCON, SONFIN and FUN are only concerned with parameters adaptation with fixed structures that's why these are suitable for small problems only. It is complicated to determine the premises parameters, consequent parameters, number of rules etc. for large scale problems because the parameters grow exponentially. The evolutionary design seems to be better solution for processes that require an optimal neuro-fuzzy system.

## VI. CONCLUSIONS

In this paper we have presented the structural differences of fused neuro-fuzzy systems. It is difficult to compare the performances of different models due to lack of common framework. The NF models which is using Takagi-Sugeno FIS performs better than the Mamdani FIS used model, although it is computational expensive. Most of the neuro-fuzzy models used the gradient descent learning to learn the membership function parameters. For a faster learning and convergence of parameters, more efficient learning algorithms such as conjugate gradient or Levenberg and Marquardt search could be used.

## REFERENCES

- [1] A. Abraham and Baikunth Nath, "Hybrid Intelligent Systems: A Review of a decade of Research", School of Computing and Information Technology, Faculty of Information Technology, Monash University, Australia, Technical Report Series, 5/2000, 2000, pp. 1-55.
- [2] H. R. Berenji and P. Khedkar, "Learning and Tuning Fuzzy Logic Controllers through Reinforcements", IEEE Transactions on Neural Networks, 1992, Vol. 3, pp. 724-740.
- [3] T. C. Lin, C. S. Lee, "Neural Network Based Fuzzy Logic Control and Decision System", IEEE Transactions on Computers, 1991, Vol.40, no. 12, pp. 1320-1336.
- [4] D. Nauck, R. Kurs, "Neuro-Fuzzy Systems for Function Approximation", 4th International Workshop Fuzzy-Neuro Systems, 1997
- [5] S. Sulzberger, N. Tschichold e S. Vestli, "FUN: Optimization of Fuzzy Rule Based Systems Using Neural Networks", Proceedings of IEEE Conference on Neural Networks, San Francisco, March 1993, pp. 312-316.
- [6] F. C. Juang, T. Chin Lin, "An On-Line Self Constructing Neural Fuzzy Inference Network and its applications", IEEE Transactions on Fuzzy Systems, 1998, Vol. 6, pp. 12-32.
- [7] S. Tano, T. Oyama, T. Arnould, "Deep combination of fuzzy inference and neural network in fuzzy inference", Fuzzy Sets and Systems, 82(2), pp. 151-160, 1996
- [8] O. Cordon, F. Herrera, F. Hoffman and L. Magdalena, "Genetic fuzzy system: Evolutionary Tuning and Learning of Knowledge Base", World scientific publishing company, Singapore, 2001
- [9] A. Abraham, "EVoNF: A framework for optimization of fuzzy inference systems using neural network learning and evolutionary computation", 17th IEEE International Symposium on Intelligent Control, ISIC-02, IEEE Press, pp. 327-332, 2002.
- [10] D. Nauck, F. Klawon; R. Kruse, "Foundations of Neuro-Fuzzy Systems", J. Wiley & Sons, 1997.
- [11] R. Fuller, introduction to Neuro-fuzzy System, Studies in Fuzziness and Soft Computing, Springer Verlag, Germany, 2000.
- [12] Kasabov N and Qun Song, Dynamic Evolving Fuzzy Neural Networks with 'm-out-of-n' Activation Nodes for On-line Adaptive Systems, Technical Report TR99/04, Department of information science, University of Otago, 1999.
- [13] H. Takagi, "Fusion Technology of Fuzzy Theory And Neural Networks-Survey and Future directions "in proceedings of first international conference on Fuzzy Logic and Neural Networks, pp.13-26, 1990.
- [14] S. Sumathi, Surekha P. , "Computational Intelligence Paradigms : Theory and Applications Using Matlab", CRC Press, Taylor and Francis Group, 2010.