

Frequency Agile Stacked Circular Microstrip Antenna for Wireless Systems

Ganga Prasad
Pandey
Department of E&C.,
Maharaja Agrasen
Institute of
Technology, Delhi,
INDIA, 110086,

Binod Kumar
Kanaujia
Department of E&C,
AIACR, Geeta
Colony, Delhi,
INDIA, 110031.

Surendra K. Gupta
Department of
Electronics,
Ambedkar
Polytechnic, Delhi,
INDIA,

A. K. Gautam
Department of E&C,
G. B. P. E. C., Pauri,
Uttarakhand, INDIA.

Abstract: A new frequency agile BST varactor loaded stacked circular microstrip antenna is presented. The antenna is analysed using extended cavity model. One of two bands of antenna is tunable with the help of BST varactor. The upper band is useful for WiMAX and lower band for other wireless communication systems. Various antenna parameters like return loss, resonant frequency, frequency agility etc. have been investigated. The simulated results agree well with the numerical data. A frequency agility of 60.64% is achieved, which is better than simple Varactor diode loaded antenna. Lowest resonant frequency of 0.866GHz is obtainable that shows a significant physical area reduction.

Key words: frequency agile, circular microstrip antenna, stacked antenna, gain, bandwidth.

1. Introduction

Microstrip antennas are becoming popular for wireless communication systems since they have low profile, light weight, low cost and integration capability with MMICs. But they suffer from low band width and low gain. But according to Chu's antenna limit theory, it is very difficult to design broadband, miniaturized, low profile antennas [1]. Bandwidth may be enhanced by different techniques but using stacked structure of microstrip antenna has been interesting in the recent years [2-6]. In [2] the author achieved an impedance bandwidth of 21.5% by stacking two rectangular microstrip antennas (RMSA). In this design the coaxial feed is moved in a circular path to obtain circular polarization with single feed. Broadband operation (impedance bandwidth of 76.25%) is achieved in [3] by shorting the edges of the stacked slot loaded rectangular microstrip antennas. The antenna presented in [4] works like inverted F antenna with 7.5 dBi right handed circularly polarized gain and 15.8% bandwidth. The antenna is applicable in satellite and terrestrial applications by switching of PIN diodes. A transmission line model is

explained rigorously for two H-shape stacked microstrip antennas [5]. By stacking, bandwidth increased from 0.42% to 5.5%. An E-shaped patch is stacked [6] on RMSA to improve the impedance bandwidth from 33.8% to 44.9%. Moreover, stacking provides many degrees of freedom like gap between layers, feed point, substrate and superstrate parameters. The feeding technique that has been extensively used in stacked patches is coaxial probe. The probe feed technique has been band-limiting due to inherent reactance [7]. Recently the frequency agile microstrip antennas have been seen as solution to the low bandwidth [8]. They don't cover whole frequency spectrum at a time but cover a narrow bandwidth with variable resonant frequency. The two layered stacked microstrip antenna has two resonant frequencies, by including a BST tunable device between ground plane and lower patch, lower resonant frequency could be varied to hop over. A tunable dual band antenna using Varactor diode has been presented [9]. Both the bands were made tunable independently. This is achieved by combining two varactor loaded antennas at common shorted end. A dual band reconfigurable slot antenna has been presented [10]. A frequency ratio ranging from 1.3 to 2.67 has been achieved. Four varactors were used to get wide tune ability [11]. To compensate the losses of four varactors, stacking was used.

In the present communication, the analysis and design of BST varactor loaded stacked circular microstrip antenna is presented for dual band operation. The antenna is tunable and useful for wireless applications. The theoretical investigation of various antenna parameters like return loss, resonant frequency was carried out. The antenna was simulated using FEM based electromagnetic simulation software Advanced Design System (ADS). The details of investigation are given in the following sections.

II. Theoretical consideration

The structure of proposed antenna is shown in fig.1. It consists of two layers of circular microstrip patches placed vertically with aligned center. The lower patch with radius a_1 is supported by a substrate of dielectric constant ϵ_{r1} and the upper one with radius a_2 placed on substrate of dielectric constant ϵ_{r2} . The thickness of the lower substrate layer is h_1 and that of the upper substrate is h_2 . In the present design both layers are filled with PTTE substrate with relative dielectric constant of 2.2. A BST varactor diode is embedded between lower circular patch (LCP) and ground plane. The center conductor of coaxial probe is electrically connected to the upper circular patch (UCP) through a hole in the lower patch. Fig. 2 shows a 3D view from ADS. The numerical analysis of antenna is presented in four parts. First part describes design of upper cavity assuming lower patch as ground plane. The lower cavity has been analyzed with superstrate, neglecting effect of upper patch in second part of analysis. In the third part, an analysis is given for stacked antenna. Lastly, theory and effect of integration of BST in stacked circular microstrip antenna has been investigated. The theoretical and simulated results are found and are in good agreement.

A. Analysis of upper patch:

The analysis of upper patch is done as simple microstrip antenna with h_2 as thickness and ϵ_{r2} as dielectric constant [12]. Reverse current induced at lower patch hence acts as ground plane. But current gets reflected from the edges of the lower patch due to its finite size. That is, the ground plane is not finite which is taken in the calculation. That is why some error is expected in the results.

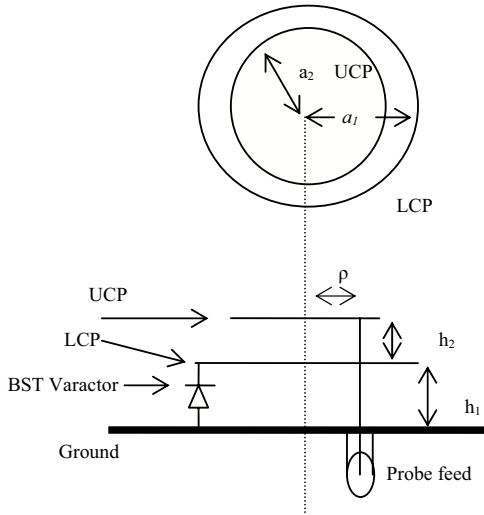

Figure 1. Structure of proposed antenna

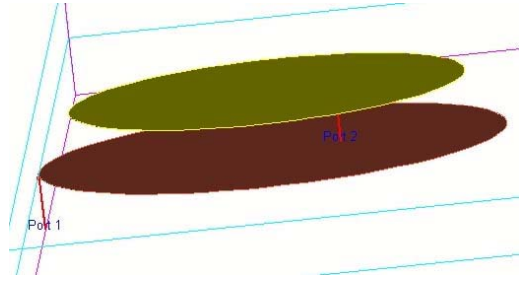

Figure2. 3D view of proposed stacked antenna from ADS

The input impedance of upper cavity is given as

$$Z_{in2} = \frac{1}{\left\{ \left(\frac{1}{R_2} \right) + (j\omega C_2) + \left(\frac{1}{j\omega L_2} \right) \right\}} \quad (1)$$

Where resistance R_2 , capacitance C_2 and inductance L_2 are equivalent circuit components for circular microstrip antenna expressed as parallel combination for TM_{np} mode.

The resonance resistance (R_2) for upper patch at feed location ρ is given by [13]

$$R_2 = \frac{1}{G_T} \frac{J_n^2(k\rho)}{J_n^2(ka_2)} \quad (2)$$

Where J_n is the first kind of Bessel function of order n , k is wave number at operating frequency, with argument $k\rho$ or ka , G_T is total conductance for upper cavity that includes dielectric loss, radiation loss, and conduction loss.

The capacitance associated with upper cavity patch is given by

$$C_2 = \frac{Q_T}{2\pi f_{res2} R_2} \quad (3)$$

and inductance L_2 of upper layer is given as

$$L_2 = \frac{R_2}{2\pi f_{res2} Q_T} \quad (4)$$

Where Q_T is total quality factor [14] of upper cavity, which includes radiation loss, dielectric loss and conduction loss. The resonant frequency (f_{res2}) for upper cavity circular microstrip antenna is calculated as [15]

$$f_{res2} = \frac{c\alpha_{np}}{2\pi a_{eff2} \sqrt{\epsilon_{reff2}}} \quad (5)$$

Where c is velocity of light in free space, α_{np} is p^{th} zero of first kind Bessel function of order n , a_{eff2} is effective radius of the upper patch and ϵ_{reff2} is effective permittivity [15] of upper substrate considering fringing effect of upper patch.

B. Analysis of lower patch:

Lower circular patch is analyzed as circular microstrip antenna with superstrate and neglecting the effect of upper patch. One or more dielectric layer above radiating patch disturbs fringing fields thus changing the effective radius of lower patch. Resonant frequency of rectangular microstrip antenna with superstrate has been calculated in [16] taking filling fraction into consideration. In this, an antenna system with one or more superstrate is represented as antenna having one substrate with same radiation characteristics. Moreover, the formulation provided in [15] along with analysis carried out in [17] is used to analyze the present problem more accurately.

The effective dielectric constant of equivalent substrate is calculated using equations (1-10) of reference [16].

Now effective radius of LCP is calculated as

$$a_{eff1} = a_1 \sqrt{(1+q)} \tag{6}$$

In this q is calculated as given in [15] where in equations (9)-(14) the result of above equation (15) is used. Using a_{eff1} as calculated in equation (16), the input impedance of LCP Z_{in1} is calculated. The antenna is assumed to be edge fed in above calculation.

C. Stacked Circular Patch:

There is no variation of electric field in z direction so total electric field is sum of the electric fields in LCP and UCP. Moreover, LCP is represented as parallel combination of a resistance (R_i), an inductance (L_i) and a capacitance (C_i). The equivalent circuit of stacked microstrip antenna may be represented as series combination of input impedances of the two antennas i.e. LCP and UCP.

Hence

$$Z_{in} = Z_{in1} + Z_{in2} \tag{7}$$

D. BST Varactor Diode Integrated Stacked Microstrip Patch:

Compared to MEMS varactors, thin-film BST capacitors exhibit a higher tuning ratio under relatively low bias voltages. High permittivity thin film dielectrics (like Barium Strontium Titanate (BST), Bizmuth Zink Niobate (BZN)) may exhibit strong field dependence in the dielectric constant that can be exploited for voltage variable capacitors in RF circuits. Varactors made from high permittivity materials show symmetrical small signal C-V characteristic. A typical BST is shown in fig. 3a while the equivalent circuit is shown in fig. 3b. The device may be modeled as series combination of bulk capacitance, $C(v)$, and interfacial capacitances, C_i , in parallel to fringing capacitance, C_f .

The bulk capacitance is given as [19]

$$C(v) = \frac{C_{max} - C_f}{2 \cosh \left[\frac{2}{3} \sinh^{-1} \left(\frac{2v}{V_2} \right) \right] - 1} + C_f \tag{8}$$

Which includes fringing capacitance given as $C_f = k_l P/d$. Zero bias capacitance is C_{max} , V_2 is voltage at which capacitance becomes half of C_{max} and k_l is a constant.

The interfacial capacitances is given as

$$C_i = \frac{\epsilon_i A}{t} \tag{9}$$

A is device area and t is thickness of “dead layer”. The BST varactor is connected between LCP and ground plane and is positioned opposite to coaxial feed. The diode is kept at the edge of the antenna.

The device impedance is calculated from fig. 4b as

$$Z_d = 1/(j\omega C_{eq}) \tag{10}$$

where

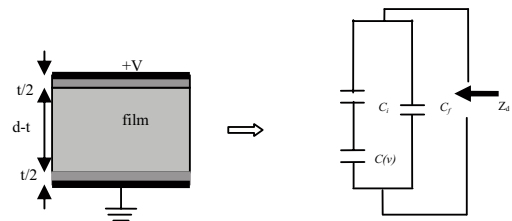

Figure 3. (a) Schematic of device (b) Equivalent

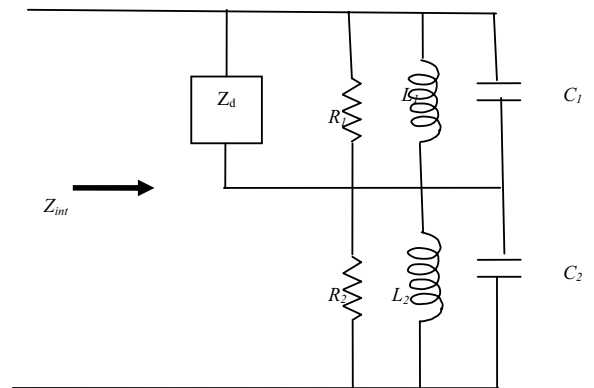

Figure 4. Equivalent circuit of stacked CMSA loaded with BST varactor

$$C_{eq} = C_f + \frac{C_i C(v)}{C_i + C(v)} \quad (11)$$

Hence total input impedance of BST varactor loaded stacked circular microstrip antenna as shown in fig. 4 is given as

$$Z_{int} = Z_{in2} + Z_{in1} Z_d / (Z_{in1} + Z_d) \quad (12)$$

and return loss is given as

$$RL = 20 \log |\Gamma| \quad (13)$$

Where reflection coefficient (Γ) for coaxial probe of characteristic impedance 50ohms is given as

$$\Gamma = (Z_{int} - 50) / (Z_{int} + 50) \quad (14)$$

III. Design Parameters:

The stacked circular microstrip antenna is designed to operate on two resonant frequencies 2.2 GHz and 3.5 GHz. The antenna design parameters are given in Table I. The radius for UCP is calculated assuming LCP as ground plane. The device parameters corresponding to 30/70 BST with Pt electrode were taken to simulate the design. This is a large area ($2000\mu\text{m}^2$) device. The value of V_2 , film thickness (d) and k_f were taken to be 13V, 210nm and 0.6fF respectively. Though for large area devices fringing capacitance and non-tunable “dead layer” capacitance could be ignored, but for more accurate results these values were accommodated in the calculation. The fringing capacitance of 5fF and thickness of “dead layer” of 30nm were taken.

TABLE I. STACKED CMSA SPECIFICATION

Parameters	Value
Radius of LCP (a_1)	26mm
Radius of UCP (a_2)	16.25mm
Height of LCP (h_1)	1.6mm
Height of UCP (h_2)	1.6mm
Relative dielectric constant of substrate & superstrate ($\epsilon_{r1} = \epsilon_{r2}$)	2.2 (PTTE)
Probe position for UCP	5.5mm
Loss Tangent ($\tan \delta$)	0.0012

IV. Results and Performance of antenna:

A MATLAB code was developed based on description given in previous sections and simulation was carried out using ADS simulation software [20]. Fig. 5 shows simulated and calculated return loss variation with frequency for simple stacked CMSA. The calculated result (fig. 5a) shows two resonances - one at 2.2 GHz and other at 3.5 GHz which were in close agreement to the simulated (fig. 5b) values of resonance 2.16 GHz and 3.47GHz.

A BST varactor of $\text{Ba}_{0.5}\text{Sr}_{0.5}\text{TiO}_3$ [19] was taken to integrate between LCP and ground plane. A low pass filter was used to prevent the RF signal to reach at DC supply used for biasing of diode. The behavior of diode is obtained by varying bias voltage from -40V to +40V. Fig. 6 shows variation of bulk capacitance of BST varactor. Similar monotonic variation is seen for both polarities of bias voltage.

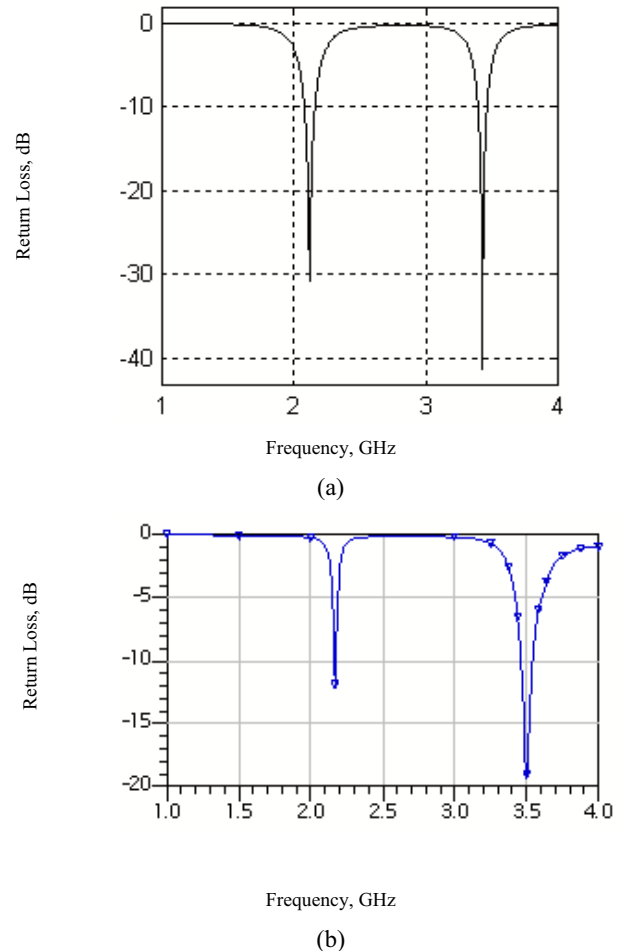

Figure 5. Return loss of Stacked CMSA (a) Calculated (b) Simulated

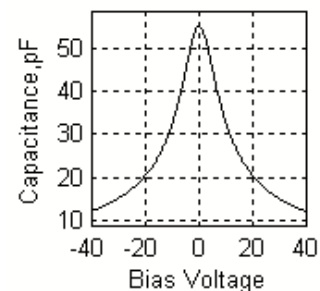

Figure 6: Variation of capacitance with bias voltage

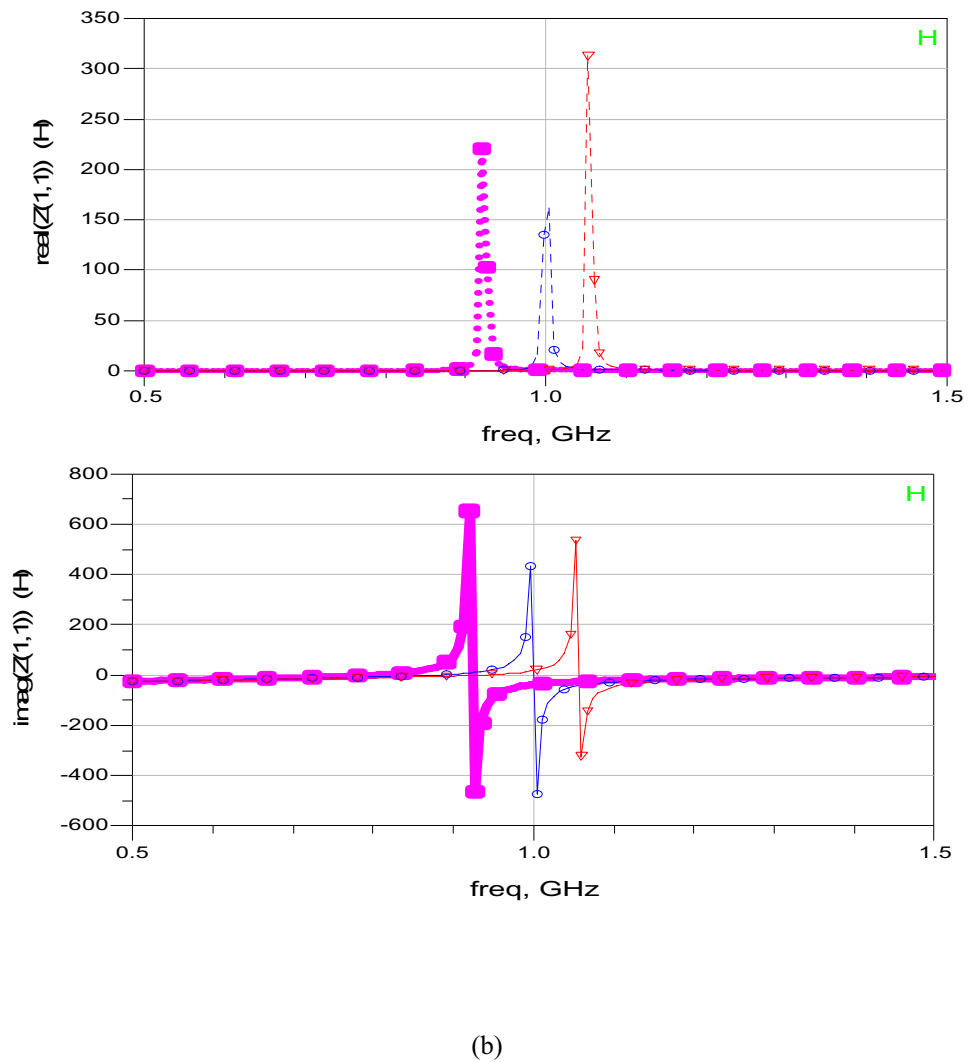
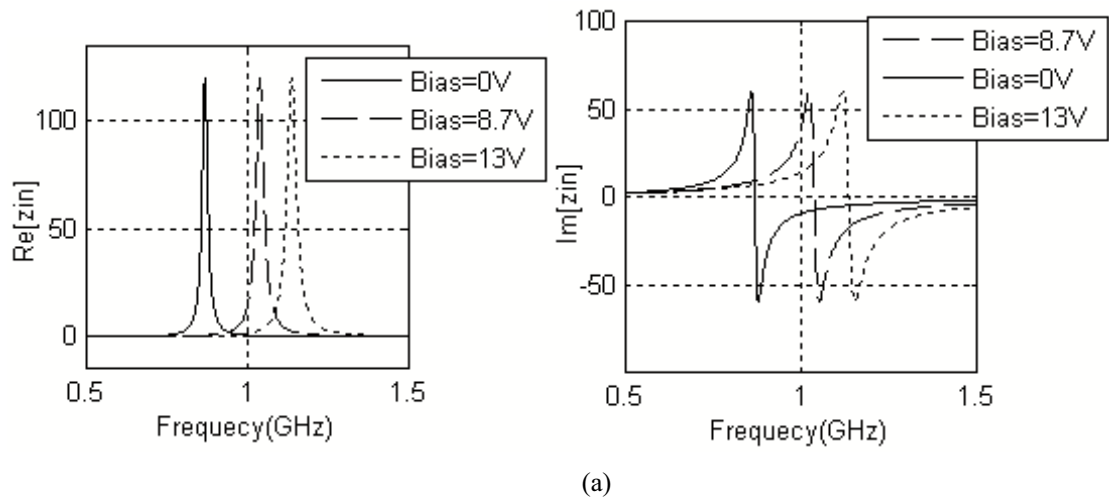

Figure 7. Real and Imaginary impedance variation with frequency (a) Calculated (b) Simulated

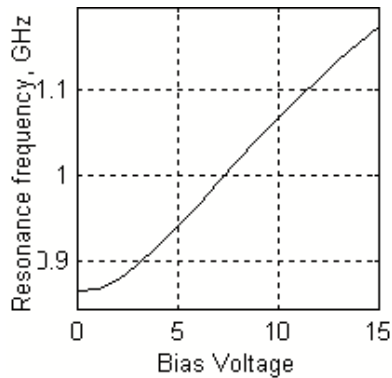

Figure 8. Variation of resonant frequency with bias voltage

Fig. 7 shows calculated and simulated impedance variation of BST loaded stacked circular microstrip antenna. The three bands in lower spectrum are corresponding to 0V, 8.7V and 13V. A close resemblance in the simulated and calculated results may be observed. The slight mismatch in the resonant frequencies is due to the fact that LCP is not providing proper ground for UCP. It is also seen that higher resonant frequency remains unchanged, while the lower bands are electrically selectable from bias voltage of diode.

The variation of resonant frequency with bias voltage is shown in fig. 8. Minimum frequency of 0.866GHz has been achieved giving 60.64% frequency agility.

v. Conclusion

A BST varactor loaded stacked circular microstrip antenna has been analyzed and designed using extended cavity model. Tuning property has been achieved using BST varactor which makes antenna suitable for wireless communication like WiMAX, UTMS and PCS bands. A significant physical area reduction has been achieved. Also a frequency agility of 60.64% has been achieved.

Acknowledgements

This research was supported by Department of Science and Technology (Vigyan Aur Prodyogiki Vibhag) government of India under SERC Scheme project sanction order No SR/S3/EECE/0117/2010(G).

References

- [1] L. J. Chu, "Physical Limitations on Omnidirectional Antennas", J. Appl. Phys., 1948, Vol. 19, pp. 1163-1175.
- [2] Nasimuddin, "Design of Wide band Circularly Polarized Stacked Microstrip Antenna with Dielectric Cover using Single Feed" Microwave and Optical technology Letters, 2007, Vol. 49, No. 12, pp. 3027-3033.
- [3] P. K. Singhal, Bhawana Dhaniram and Smita Banerjee, "A stacked Square Patch Slotted Broadband Microstrip Antenna", Journal of Microwaves and Optoelectronics, 2003, Vol. 3, No. 2, pp. 60-66.

- [4] Mohammad Ali, Abu T. M. Sayem and Vijay K. Kunda, "A Reconfigurable Stacked Microstrip Antenna for Satellite and Terrestrial Link", IEEE Trans. on Vehicular Technology, 2007, Vol. 56, No. 2, pp. 426-435.
- [5] Jaume Anguera, Lluís Boada, Carles Puente, Carmen Borja and Jordi Solar, "Stacked H-Shaped Microstrip Patch Antenna", IEEE Trans. on Antenna and Propag., 2004, Vol. 52, No. 4, pp. 983-993.
- [6] Ban-Leong Ooi, Shen Qin and Mook-Sheg Leong, "Novel Design of Broad Band Stacked Patch Antenna", IEEE Trans. on Antenna and Prop., 2002, Vol. 50, No. 10, pp. 1391-1395.
- [7] K. M. Luk, K.F. Lee and Y. L. Chow, "Proximity-coupled stacked circular-disc microstrip antenna with slots", Electronics Letters, 1998, Vol. 34, No. 5, pp. 419-420.
- [8] Ganga Prasad Pandey, Binod Kumar Kanaujia and Surendra K. Gupta, "Double MOS Loaded Circular Microstrip Antenna for Frequency Agile", Proc. IEEE Int. Conf. Applied Electromagnetic Conference, Kolkata, India, Dec-2010.
- [9] A. E. Sheta and M.A. Alkanhal, "Compact Dualband Tunable Microstrip Antenna for GSM/DCS-1800 Applications", IET Microwave Antennas Propagation, 2008, Vol. 2, No. 3, pp. 274-280.
- [10] N. Behdad and K. Sarabandi, "Dual band Reconfigurable Antenna with Very Wide Tunability Range", IEEE Transactions on Antenna and Propagation, 2006, Vol. 54, No. 2, pp. 409-416.
- [11] E. Nishiyama and T. Itoh, "Widely Tunable Stacked Microstrip Antenna using Varactor Diodes", APMC 2008.
- [12] Javier Gómez-Tagle and Christos G. Christodoulou, "Extended Cavity Model Analysis of Stacked Microstrip Ring Antennas", IEEE Transactions on Antennas and Prop., 1997, Vol. 45, No. 11, pp. 1626-1635.
- [13] I. J. Bahl and P. Bhartia, 'Microstrip Antennas', Artech House, Dedham, MA, 1980.
- [14] F. Abboud, J. P. Damiano and A. Papiernik, "A new model for calculating the input impedance of coax-fed circular microstrip antennas with and without air gaps", IEEE Transaction on Antenna and Propagation, 1990, Vol. 38, No. 11, pp. 1882-1885.
- [15] Debatosh Guha, "Resonant Frequency of Circular Microstrip Antennas with and without Air Gaps", IEEE Transaction on Antenna and Propagation, 2001, Vol. 49, No.1, pp. 55-59.
- [16] Jenifer T. Bernhard and Carolyn J. Tousignant, "Resonant Frequencies of Rectangular Microstrip Antennas with flush and Spaced dielectric Superstrates", IEEE Transaction on Antenna and Propagation, 1999, Vol. 47, No.2, pp. 302-308.
- [17] Debatosh Guha and Jawad Y. Siddiqui, "Resonant Frequency of Microstrip antenna Covered with Dielectric Superstrate", IEEE Transaction on Antenna and Propagation, 2003, Vol. 51, No.7, pp. 1649-1652.
- [18] J. R. James and P. S. Hall, 'Handbook of Microstrip Antennas', Peter Peregrinus, London, UK, 1989.
- [19] David R. Chase, Lee Yin Chen and Robert A. York, "Modeling the Capacitive Non-Linearity in Thin Film BST Varactors", IEEE Trans. On Microwave theory and Techniques, Vol. 53, No. 10, Oct. 2005.
- [20] ADS Simulation software v2011.