

# Epidemic Model For Ebola Disease

[Tri Juliansyah M. Sambas, Dipo Aldila, Edy Soewono]

**Abstract**— Outbreaks of Ebola disease in early 2014 in West Africa is a major highlight for researchers throughout the world because of the high mortality rate. Ebola disease is caused by a virus named Ebola virus which can be transmitted from infected humans to healthy humans through direct contact with their body fluids. But there is another evidence that Ebola virus can be transmitted through the bodies of humans who recently died from the disease. Because of that, this epidemic model for Ebola disease is built by considering the number of human bodies who recently died from the disease. The epidemic model is constructed with a *SEIRD* model, in which the addition D compartment represents the number of human bodies who recently died from Ebola disease. Two control parameters are included in the model in the form of a rate of isolation of infected persons and the expose period of the dead bodies. The basic reproductive number  $R_0$  is obtained and sensitivity analysis of  $R_0$  is shown.

**Keywords**— Basic Reproductive Number, SEIRD model, Ebola, Body fluids

## I. Introduction

Ebola disease known as the Ebola Hemorrhagic Fever is a disease caused by a virus called Ebola [1]. The Ebola disease is first discovered in 1976 in Central Africa. It was transmitted to humans by animals but then the virus is able to spread within human population and caused the outbreak as in 2014 [1]. The infection occurs when a person has a direct contact with body fluids of the infected person [1,2]. The body fluids such as saliva, mucus, vomiting, feces, sweat, tears, urine, mother milk, semen and vaginal discharge are identified as media for transmitting the virus [2]. In addition, there are other facts mentioned that the Ebola virus can be transmitted through body fluids of a dead person which has been infected with Ebola [2].

In early 2014 outbreak in West Africa, it was reported that about 30% of infections were caused by a contact with the dead bodies who recently died because of Ebola disease [3]. The number of dead bodies who recently died because of Ebola disease is related to the rate of the infection because of its burial process [7,8]. This evidence motivates us to explore the effect of burial process in a model of Ebola virus transmission by adding dead compartment [4].

Although there is another method to describe the infection caused by the dead person such as increasing the rate of infection or extending the infection period [9,10,13], we are interested to explicitly see the number of dead body in the system and its effect to the basic reproductive number [4].

In the model that we have built, there are two control parameters that affect the transmission of Ebola virus. One form of control is to accelerate the burial process of the bodies of people who recently died from the Ebola disease. This form of control is necessary due to the fact that the Ebola virus can survive in the dead bodies for 7 days [5]. The other control parameter is to isolate infected humans to reduce the transmission of Ebola virus from infected humans. It is expected that the a model can represent the phenomenon of the Ebola epidemic disease more spesific.

## II. Methods

A dynamical system consisting ordinary differential equation is used to construct the Ebola disease model in this article. The model is developed with an addition of D compartment and two new parameters in SEIR model which already introduced well in [4] to accommodate human death body caused by Ebola disease. Equilibrium points and stability criteria are shown analytically. Basic reproductive number ( $R_0$ ) as endemic criteria for the model are given to see sensitivity analysis between parameters.

### A. Mathematical Model

In this model, we assume that human population is divided into susceptible compartment (S), exposed compartment (E), non-isolated infection and isolated infection compartment (I and  $I_s$ ), recovered compartment (R) and death compartment (D). We have two intervention parameters, i.e. with isolating infected people and buried death people caused by Ebola as soon as possible to prevent further infection to other people. We have developed a model that follows the rules of the system of differential equations in [11].

Transmission diagram which illustrate infection process in Ebola disease in this article is given by figure below.

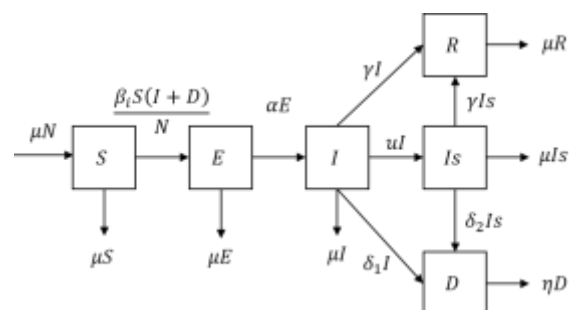

Figure 1. Transmission diagram for Ebola disease

Explanation about above transmission diagram is given as follow. Susceptible human (S) could be infected by Ebola disease by interaction with infected human (I) and/or death

Tri Juliansyah M. Sambas, Edy Soewono  
 Institut Teknologi Bandung  
 Indonesia

Dipo Aldila  
 University of Indonesia  
 Indonesia

body (D) which is described in the term of  $\frac{\beta_1 SI}{N}$  and  $\frac{\beta_2 SD}{N}$ . Incubation period for Ebola disease from E to I is approximately between 8 to 12 days [3,12] and given by  $\frac{1}{\alpha}$ . To control infection intensity some portion of Infectious people will be isolated and separated into Isolated Infectious (Is) compartment with the rate u. Because of human natural immune system, people could recover from Ebola disease with infection period of  $\frac{1}{\gamma}$ , and approximately between 5 to 9 days [3].

With transmission diagram in Figure 1 and explanation above, a six dimensional system of differential equations to describe the spread of Ebola disease is given by

$$\begin{aligned} \frac{dS}{dt} &= A - \frac{\beta_1 SI}{N} - \frac{\beta_2 SD}{N} - \mu S, \\ \frac{dE}{dt} &= \frac{\beta_1 SI}{N} + \frac{\beta_2 SD}{N} - (\alpha + \mu)E, \\ \frac{dI}{dt} &= \alpha E - (\gamma + u + \delta_1 + \mu)I, \\ \frac{dIs}{dt} &= uI - (\gamma + \delta_2 + \mu)Is, \\ \frac{dR}{dt} &= \gamma(I + Is) - \mu R, \\ \frac{dD}{dt} &= \delta_1 I + \delta_2 Is - \eta D, \end{aligned} \quad (1)$$

With initial condition at t=0 is given. We assume all parameters are non-negative and total population (live and death compartment) is given by

$$N = S + E + I + Is + R + D.$$

Description of each parameters is given in Table 1.

## B. Mathematical Model Analysis

The equilibrium points ( $S^*$ ,  $E^*$ ,  $I^*$ ,  $Is^*$ ,  $R^*$ ,  $D^*$ ) is obtained the following equations.

$$\begin{aligned} A - \frac{\beta_1 SI}{N} - \frac{\beta_2 SD}{N} - \mu S &= 0, \\ \frac{\beta_1 SI}{N} + \frac{\beta_2 SD}{N} - (\alpha + \mu)E &= 0, \\ \alpha E - (\gamma + u + \delta_1 + \mu)I &= 0, \\ uI - (\gamma + \delta_2 + \mu)Is &= 0, \\ \gamma(I + Is) - \mu R &= 0, \\ \delta_1 I + \delta_2 Is - \eta D &= 0. \end{aligned}$$

Further the basic reproductive number of system equation (1) from next-generation matrix [6] will be given.

### 1) Equilibrium Points

The disease free equilibrium is obtained as,

$$\left\{ S^* = \frac{A}{\mu}, E^* = 0, I^* = 0, Is^* = 0, R^* = 0, D^* = 0 \right\}.$$

The other equilibrium point is a non trivial equilibrium, i.e. endemic equilibrium point when all compartment is positive. In this case, because of complexity it is not possible to show this equilibrium point explicitly. However, to determine the conditions that the disease will lead to endemic equilibrium or endemic disease free equilibrium requires a threshold. This threshold is obtained by considering a sufficient condition of the existence of endemic equilibrium point. The endemic equilibrium point ( $S^*$ ,  $E^*$ ,  $I^*$ ,  $Is^*$ ,  $R^*$ ,  $D^*$ ) exist if  $R_1 > 1$ , where

$$R_1 = \frac{\alpha\beta_1\eta(\gamma+\mu+\delta_2)+\alpha\beta_2(\gamma\delta_1+\mu\delta_1+u\delta_2+\delta_1\delta_2)}{(\alpha+\mu)(\gamma+\delta_1+\mu+u)(\gamma+\mu+\delta_2)\eta}. \quad (2)$$

### 2) Basic Reproductive Number

In many mathematical model of infectious disease, Basic reproductive number or  $R_0$  plays an important role to describe the qualitative analysis of the model, such as existence and stability criteria of the equilibrium points. Basic reproductive number is defined expected number of secondary case from one primary case in one infection period [6]. If  $R_0 < 1$ , then the disease free equilibrium point will be asymptotically stable [14]. As a consequence, the Ebola will disappear from population. Otherwise, the disease free equilibrium point becomes unstable if  $R_0 > 1$  [14]. As a consequence, Ebola will coexistence in the population.

Basic reproductive number will be taken from spectral radius of the next generation matrix of the model [See 6 for further detail]. Here below we construct the next-generation matrix of system equation (1) in form of

$$\begin{bmatrix} 0 & \frac{\beta_1}{\gamma+\delta_1+\mu+u} & 0 & \frac{\beta_2}{\eta} \\ \frac{\alpha}{\alpha+\mu} & 0 & 0 & 0 \\ 0 & \frac{u}{\gamma+\delta_1+\mu+u} & 0 & 0 \\ 0 & \frac{\delta_1}{\gamma+\delta_1+\mu+u} & \frac{\delta_2}{\gamma+\mu+\delta_2} & 0 \end{bmatrix} \quad (3)$$

As we write above, basic reproductive ratio will be taken from spectral radius of the next-generation matrix (3) [6]. Polynomial characteristic of (3) to perform the eigenvalues is given by

$$f(\lambda) = C_4\lambda^4 - C_2\lambda^2 - C_1\lambda - C_0 \quad (4)$$

with

$$\begin{aligned} C_4 &= \eta(\alpha + \mu)(\gamma + \delta_1 + \mu + u)(\gamma + \mu + \delta_2), \\ C_2 &= \alpha\eta\beta_1(\gamma + \mu + \delta_2), \\ C_1 &= \alpha\delta_1\beta_2(\gamma + \mu + \delta_2), \\ C_0 &= \alpha\delta_2u\beta_2. \end{aligned}$$

For simpler model, when  $\beta_2 = 0$  (no contact between susceptible human with human corpse caused by Ebola disease), we reduce characteristic polynomial (4) into

$$f_1 = \lambda^2(C_4\lambda^2 - C_2)$$

With largest positive root given by  $\sqrt{\frac{C_2}{C_4}}$ . Therefore, basic reproductive number without contact between S and D is given by

$$R_0^* = \sqrt{\frac{\alpha\beta_1(\gamma + \mu + \delta_2)}{(\alpha + \mu)(\gamma + \delta_1 + \mu + u)(\gamma + \mu + \delta_2)}}.$$

The other simpler case which important to look through is when  $\beta_1 = 0$  (no contact between susceptible and infectious human), then equation (4) will reduced in to

$$f_2 = -C_1\lambda - C_0.$$

We have  $f(\lambda) = f_1(\lambda) + f_2(\lambda)$  (see Figure 2). We have the largest root of  $f(\lambda)$  occurs at  $(0, \infty)$ , then we conclude that  $f(1) < 0$  if and only if  $R_0 > 1$ . We also have  $R_1 = 1$  if and only if  $f(1) = 0$ , where  $R_1$  is given in.

Hence we have an alternative threshold  $R_1$ , in which  $R_1 \geq 1$  if and only if  $R_0 \geq 1$  (and consequently  $R_1 < 1$  if and only if  $R_0 < 1$ ). This invention is very important for further analysis, because the basic reproductive number,  $R_0$  cannot be obtained explicitly.

### III. Numerical Results

All parameters and interval of initial condition for each state variable in equation (1) is given in Table 1 for numerical purposes.

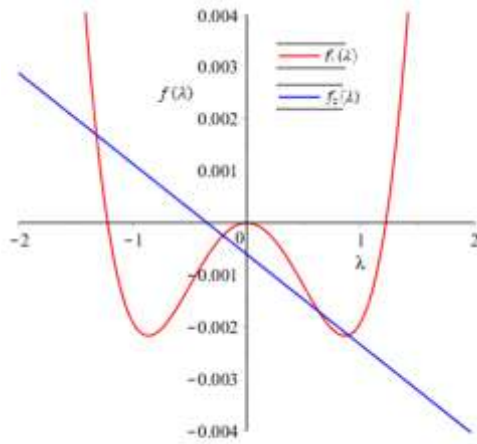

Figure 2. An illustration for the addition of  $R_0$  value due to an infection caused by contact with infected bodies..

#### 3) Sensitivity Analysis

Relation between  $R_0$  and  $R_1$  could be used to analyze the sensitivity between  $R_0$  to the other parameters, for example intervention of isolation and the burial process. In Figure 3, we give sensitivity between  $u$  and  $\eta$  for some level set of  $R_1$ .

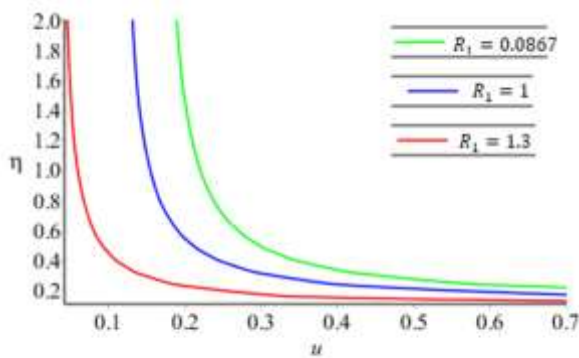

Figure 3. Parameter sensitivity of  $R_1$  with respect to  $\eta$  and  $u$ .

In Figure 3, it can be seen that to reduce  $R_1$ , larger  $u$  and  $\eta$  is needed. In Biological interpretation, it is shown that larger rate of isolation of infected people and as soon as possible buried death body to avoid further infection possibility is needed to do partially to reduce endemicity of Ebola, rather than do the intervention in single way. Also from this Figure, it can be seen that isolation intervention of infected people is much better to reduce  $R_1$  rather than acceleration of buried death body.

TABLE I. VARIABLES AND PARAMETERS

Var/Par	Description (Dimensions)	Value	Source
$S$	Susceptible humans (humans)	$[0, N]$	-
$E$	Exposed humans (humans)	$[0, N]$	-
$I$	Infected humans (humans)	$[0, N]$	-
$I_s$	Isolated humans (humans)	$[0, N]$	-
$R$	Recovered humans (humans)	$[0, N]$	-
$D$	Dead bodies (bodies)	$[0, N]$	-
$A$	Recruitment rate ( $\text{day}^{-1}$ )	$\mu N$	-
$\mu$	Natural death rate ( $\text{day}^{-1}$ )	$\frac{1}{65 \times 365}$	-
$\beta_1$	Contact rate with Infected	-	-
$\beta_2$	Contact rate with Dead bodies	-	-
$\alpha$	Incubation rate ( $\text{day}^{-1}$ )	$\frac{1}{11}$	[3,4]
$\gamma$	Recovery rate ( $\text{day}^{-1}$ )	$\frac{1}{8}$	[3]
$u$	Isolation rate ( $\text{day}^{-1}$ )	-	-
$\delta_1$	Death rate on infected ( $\text{day}^{-1}$ )	$\frac{1}{10}$	[3]
$\delta_2$	Death rate on isolated ( $\text{day}^{-1}$ )	$\frac{1}{15}$	[3]
$\eta$	Burial rate ( $\text{day}^{-1}$ )	-	-

First simulation is given without any intervention variable, such as burial acceleration and/or isolation of infected people as shown in Figure 4 and 5. Comparison of the dynamic in Figure 4 and 5 have tell us that without any intervention ( $u$  and  $\eta$ ), the dynamic of infected people will reach the peak at number of 18 people in 53-th days and decreasing rapidly after that. This is as a consequences of the number of exposed people which reach almost twice of infected people all the time.

Next simulation on Figure 6 is given with positive value of  $\eta$  and zero isolation ( $u=0$ ). We give burial rate intervention twice larger than first simulation in Figure 4 and 5. As shown in Figure 6, intervention of larger rate of  $\eta$  is give a better result to reduce number of death people, even tough not as much significant.

Last simulation is given in Figure 7 to see how isolation programme made a significant impact in reducing number of  $E$ , and  $I$  compartment. It is shown that in Figure 7 and 8, with intervention of isolation rate  $u=0.2$ , number of Exposed people could reduce almost a half from case when there is no intervention of  $u$  in Figure 4 and 5. On the other hand, number of susceptible people may not decreasing so far as previous simulation in Figure 4 and 5.

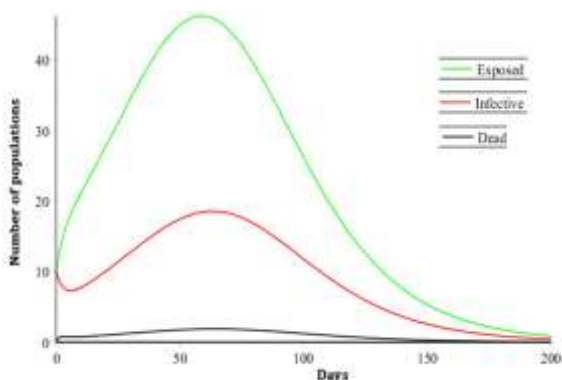

Figure 4. Numerical simulation of system (1) without intervention of  $u$  and  $\eta$  (E, I and D).

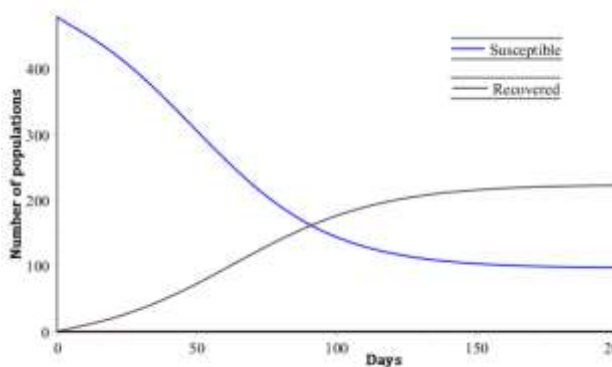

Figure 5. Numerical simulation of system (1) without intervention of  $u$  and  $\eta$  (R and S).

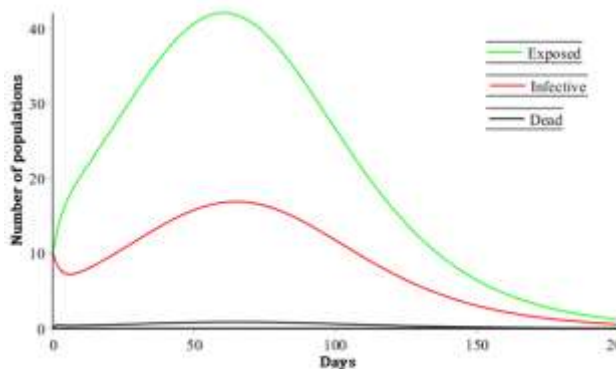

Figure 6. Numerical simulation for E, I and D compartment with  $\eta$  twice larger from simulation in Figure 4 and 5.

## IV. Discussions

In this article, mathematical model of Ebola disease with intervention in the form of isolation to infected people and also acceleration to buried death people because of Ebola is constructed as SEIR-modified model.

Equilibrium point and Basic reproductive number as the endemic criteria which is taken from spectral radius of next-generation matrix of system (3) is given analytically. Even  $R_0$  could not show explicitly,  $R_1$  as alternative threshold number of  $R_0$  could be shown (2).

Sensitivity analysis of  $R_1$  for parameters of  $u$  and  $\eta$  have tell us that larger of  $u$  and  $\eta$  will reduce  $R_1$  significantly, especially for isolation ( $u$ ) intervention. Intervention of isolation program is much recommended to reduce number of Ebola disease rather than accelerate buried death people caused by Ebola.

Further model development could be taken with make the problem above as an optimal control problem to see an optimal result to reduce Ebola disease with consideration of limitation of budgeting.

## Acknowledgment

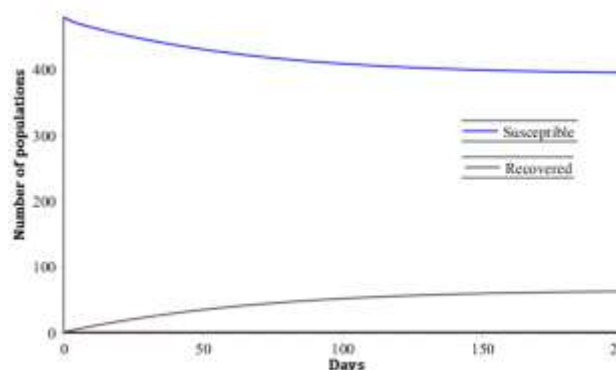

Figure 8. Numerical simulation of system (1) with isolation parameter  $u=0.2$  (S and R)

This research is funded by Hibah Unggulan DIKTI-ITB 2015.

## References

- [1] WHO fact sheet : Ebola virus disease.
- [2] CDC website : Ebola – QAs on Transmission (2015). URL <http://www.cdc.gov/vhf/ebola/transmission/qas.html>
- [3] WHO Ebola Response Team. Ebola virus disease in West Africa – the first 9 months of epidemic and forward projections. *New England Journal of Medicine* **371**, 1481-1495 (2014).
- [4] Weitz, Joshua S., and Jonathan Dushoff. "Modeling Post-death Transmission of Ebola: Challenges for Inference and Opportunities for Control." *Scientific reports* **5** (2015).
- [5] Prescott, J., Bushmaker, T., Fischer, R., Miazgowicz, K., Judson, S., & Munster, V. J. (2015). Postmortem stability of Ebola virus. *Emerging infectious diseases*, *21*(5), 856.
- [6] Diekmann, O., Heesterbeek, J. A. P., & Roberts, M. G. (2009). The construction of next-generation matrices for compartmental epidemic models. *Journal of the Royal Society Interface*, rsif20090386.
- [7] Legrand, J., Grais, R. F., Boelle, P. Y., Valleron, A. J., & Flahault, A. (2007). Understanding the dynamics of Ebola epidemics. *Epidemiology and infection*, *135*(04), 610-621.
- [8] Rivers, C. M., Lofgren, E. T., Marathe, M., Eubank, S., & Lewis, B. L. (2014). Modeling the impact of interventions on an epidemic of Ebola in Sierra Leone and Liberia. *PLoS currents*, *6*.
- [9] Meltzer, M. I., Atkins, C. Y., Santibanez, S., Knust, B., Petersen, B. W., Ervin, E. D., ... & Washington, M. L. (2014). Estimating the future number of cases in the Ebola epidemic—Liberia and Sierra Leone, 2014–2015. *MMWR Surveill Summ*, *63*(suppl 3), 1-14.

- [10] Althaus, C. L. (2014). Estimating the reproduction number of Ebola virus (EBOV) during the 2014 outbreak in West Africa. *PLoS currents*, 6.
- [11] Brauer, F., Castillo-Chavez, C., & Castillo-Chavez, C. (2001). *Mathematical models in population biology and epidemiology* (Vol. 1). New York: Springer.
- [12] Eichner, M., Dowell, S. F., & Firese, N. (2011). Incubation period of Ebola hemorrhagic virus subtype Zaire. *Osong public health and research perspectives*, 2(1), 3-7.
- [13] Chowell, G., Hengartner, N. W., Castillo-Chavez, C., Fenimore, P. W., & Hyman, J. M. (2004). The basic reproductive number of Ebola and the effects of public health measures: the cases of Congo and Uganda. *Journal of Theoretical Biology*, 229(1), 119-126.
- [14] Van den Driessche, P., & Watmough, J. (2002). Reproduction numbers and sub-threshold endemic equilibria for compartmental models of disease transmission. *Mathematical biosciences*, 180(1), 29-48.

About Author (s):



Tri Juliansyah M. Sambas  
Student of Mathematics  
Institut Teknologi Bandung