

Design of RF CMOS Gilbert Cell Mixer at 30MHz Using 0.12μm Technology

Shrawan Kumar Patel¹

Asst. Professor

Department of ECE

Institute of Technology, GGV, Bilaspur, India

Ram Krishna Dewangan²

Asst. Professor

Department of ECE

Institute of Technology, GGV, Bilaspur, India

Abstract - Frequency translation in a system, is performed by a non-linear device known as a mixer. There are various topographies from simple single ended, single balanced mixers to more complicated double & triple balanced mixers that provide better isolation from the Local Oscillator (LO) and spurious. The most popular double-balanced mixer used in RFIC designs is the Gilbert Cell mixer. The design of this mixer at 30 MHz frequency is the subject of this paper.

Keywords – Double balanced Gilbert Mixer, Conversion gain, Noise Figure, Isolation, Linearity, Low Power design.

I. INTRODUCTION

Nonlinear devices such as a diode, BJT, or FET can generate multiple harmonics and intermodulated signals, and so can be used as a mixer. Let's consider how a nonlinear device can generate the sum or difference frequency components of two input signals referring to fig(1).

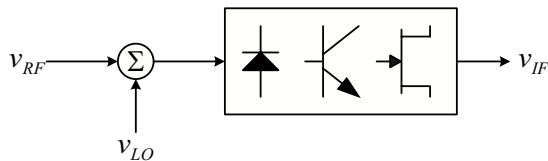

Fig(1) Basic mixing concept using a nonlinear devices

Both diode and BJT have an exponential characteristic as expressed by the following Shockley diode equation :

$$i_D = I_D + i_d = I_S \cdot (e^{v_D/\eta V_T} - 1) \cong I_S \cdot e^{v_D/\eta V_T} ,$$

approximated for forward-biased.

If the voltage $v_D = V_D + v_d$ is applied across the diode, the diode current is

$$i_D = I_S \cdot e^{(V_D+v_d)/\eta V_T} = I_S \cdot e^{V_D/\eta V_T} \cdot e^{v_d/\eta V_T} = I_D \cdot e^{v_d/\eta V_T}$$

Expanding by Taylor series,

$$i_D = I_D \cdot [1 + \left(\frac{1}{\eta V_T}\right)v_d + \frac{1}{2}\left(\frac{1}{\eta V_T}\right)^2 v_d^2 + \frac{1}{6}\left(\frac{1}{\eta V_T}\right)^3 v_d^3 + \dots]$$

$$= a_0 + a_1 \cdot v_d + a_2 \cdot v_d^2 + a_3 \cdot v_d^3 + \dots$$

If the ac signal voltage applied to the diode is

$$v_d = v_{RF} \cdot \sin \omega_{RF} t + v_{LO} \cdot \sin \omega_{LO} t , \text{ then}$$

$$i_d = a_1 \cdot (v_{RF} \cdot \sin \omega_{RF} t + v_{LO} \cdot \sin \omega_{LO} t)$$

$$+ a_2 \cdot \left[\frac{1}{2} v_{RF}^2 (1 - \cos 2\omega_{RF} t) + v_{LO} v_{RF} \{ \cos(\omega_{RF} - \omega_{LO}) t - \cos(\omega_{RF} + \omega_{LO}) t \} \right]$$

$$+ \frac{1}{2} v_{LO}^2 (1 - \cos 2\omega_{LO} t)$$

$$+ \dots \dots \dots \text{eq.(1)}$$

From this equation, it is clear that the nonlinear devices can generate new frequency components $\omega_{RF} \pm \omega_{LO}$ corresponding to the IF frequency.

II. MIXER DEFINITIONS

A. Conversion Gain / Loss

This is the ratio (in dB) between the IF signal (usually the difference frequency between the RF and LO signals) and the RF signal.

Conversion gain is given by:

$$G_{C,voltage} = \left(\frac{V_{RF}}{V_{IF}} \right) \quad G_{C,power} = \left(\frac{P_{RF}}{P_{IF}} \right)$$

B. Noise Figure

Noise figure is defined as the ratio of SNR at the IF port to the SNR of the RF port.

When specifying the noise figure of a mixer, distinction must be made as to whether the input is a SSB or DSB signal. Double sideband (DSB) noise figure includes noise and signal contributions at both the RF and the image frequencies. On the other hand, considering single sideband (SSB) noise figure, no image signal is included although image noise is

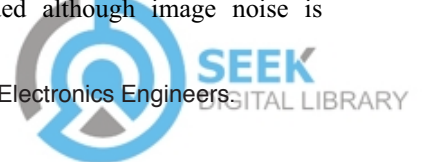

included. Provided the mixer performance is the same at the image and the wanted frequencies, the SSB noise figure is twice DSB noise figure.

C. Port-to-Port Isolation

Isolation is defined as the attenuation in dB between a signal input at any port and its level measured at any other port. In the down-conversion mixer, the isolation between LO and RF ports of the mixer is important because LO-to-RF feedthrough results in LO signal leakage through the antenna. Also, large LO and RF feedthrough signals at the IF output port may saturate the IF output port, and decrease the P_{-1dB} of the mixer.

D. (4) Linearity

(i) 1dB Compression point: Like other non-resistive networks, a mixer is amplitude-nonlinear above a certain input level resulting in a gain compression characteristic as shown in below Figure.

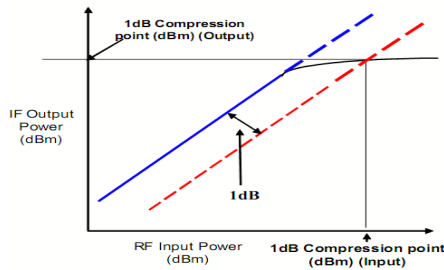

Above this point the If fails to track the RF input power level – normally a 1dB rise in RF power will result in a 1dB rise in the IF power level. The 1dB compression point is measured by plotting incident RF power against IF power as shown in the figure above.

III. DESIGN APPROACH FOR CMOS MIXER

(1) Double balanced Gilbert Cell:

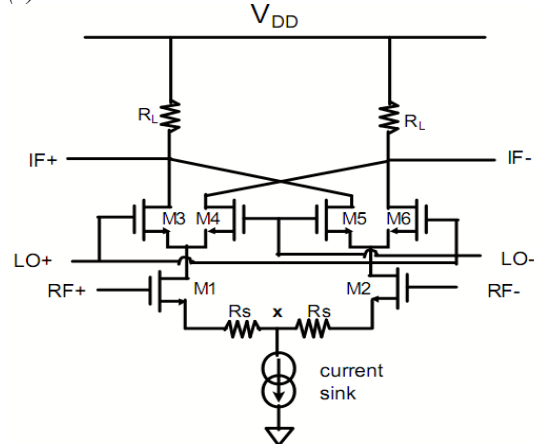

The model file used in the design is the level=49

model and the values for the models are shown in table:

Design Specification:

Parameter	Value
Technology (L)	0.12um
Supply voltage	2.5V
Bias current (Iss)	4 mA
Transconductance Parameter (K')	446.26 uA/ V ²
Conversion Voltage Gain	> 4 dB
Power dissipation	<10mW
LO to IF Isolation	>35dB

(A.) Current Mirror

A current sink of Iss = 4 mA was chosen to drive the Mixer. Therefore 2 mA current is split into between two differential pairs. A voltage of 0.4V was chosen at node x to keep current sink into saturation.

$$V_{gs,7} = V_{gs,8} = V_{ds,7} = V_{tho} + 0.3 = 1V$$

For M8 transistor in Saturation:

$$I_8 = \frac{1}{2} K_n ' \left(\frac{w}{l} \right)_8 (V_{gs} - V_t)^2$$

$$\left(\frac{w}{l} \right)_8 = \frac{4 \times 10^{-3} \times 2}{446.26 \times 10^{-6} \times (1 - 0.761)^2} = 311.22$$

$$w_8 = 37.34 \mu m$$

For M7 in saturation:

$$\frac{I_7}{I_8} = \frac{w_7}{w_8}$$

$$w_7 = 0.9335 \mu m$$

R_{ref} can be calculated as:

$$R_{ref} = \frac{V_{DD} - V_{ds7}}{I_7} = 15 k\Omega$$

(B) RF Stage

To prevent compression of output voltage from Vdd, we take drop at RL = 0.5 v

$$So, R_l = \frac{V_{DD} - V_{RL}}{I_{SS} / 2} = \frac{2.5 - 2.0}{2} = 250 \Omega$$

The small signal gain, transconductance of MOS M1

$$g_m = \frac{\partial I_d}{\partial V_{gs}} \Big|_{V_{ds} = const} =$$

$$2 K_n ' \left(\frac{w}{l} \right) (V_{gs} - V_t)$$

$$g_m^2 = \left[4 K_n ' \left(\frac{w}{l} \right) \cdot K_n ' \left(\frac{w}{l} \right) (V_{gs} - V_t)^2 \right]$$



$$g_m^2 = 4 K_n' \left(\frac{w}{l} \right) \cdot I_{ds}$$

Voltage gain (AV) = 4 dB = 2.51v/v

To preserve from headroom, Rs was chosen such that voltage drop does not exceed 0.1 v.

$$R_s = \frac{V_{drop}}{I_{ss}/2} = \frac{0.1}{2 \times 10^{-3}} = 50 \Omega$$

(a). Without Source Degeneration

Voltage gain (AV) = $\frac{2}{\pi} (R_s \cdot g_m)$

$$2.51 = \frac{2}{\pi} (250 \cdot g_m)$$

$$g_m = \frac{2.51 \times 3.14}{2 \times 250} = 15.76 \times 10^{-3} \text{ mho}$$

Width of MOS M1 and M2:-

$$w_1 = w_2 = \frac{g_m^2 \cdot l_1}{4 k_n' \cdot \left(\frac{I_{ss}}{2} \right)}$$

$$w_1 = w_2 = \frac{(15.76 \times 10^{-3})^2 \times 0.12 \times 10^{-6}}{4 \times 446.26 \times \left(\frac{2 \times 10^{-3}}{2} \right)} = 16.7 \mu m$$

(b). With Source Degeneration:

$$\text{Voltage gain (AV)} = \frac{2}{\pi} \left(\frac{R_L}{R_s + 1/g_m} \right)$$

(1). For $R_s = 50 \Omega$

$$\frac{1}{g_m} = \frac{2}{\pi} \left(\frac{R_L}{A_v} \right) - R_s$$

$$\frac{1}{g_m} = \frac{2 \times 250}{\pi \times 2.51} - 50$$

$$g_m = 74.4 \times 10^{-3} \text{ mho}$$

Width of MOS M1 and M2:-

$$w_1 = w_2 = \frac{g_m^2 \cdot l_1}{4 k_n' \cdot \left(\frac{I_{ss}}{2} \right)}$$

$$w_1 = w_2 = \frac{(74.4 \times 10^{-3})^2 \times 0.12 \times 10^{-6}}{4 \times 446.26 \times \left(\frac{2 \times 10^{-3}}{2} \right)} = 372.11 \mu m$$

(2). For $R_s = 25 \Omega$

$$g_m = 26.01 \times 10^{-3} \text{ mho}$$

Width of MOS M1 and M2:

$$w_1 = w_2 = \frac{(26.01 \times 10^{-3})^2 \times 0.12 \times 10^{-6}}{4 \times 446.26 \times \left(\frac{2 \times 10^{-3}}{2} \right)}$$

$$w_1 = w_2 = 45.47 \mu m$$

(C) LO Stage

To put M3 to M7 in saturation, take $V_{gs} = 1.0$ v for proper switching

$$\frac{I_{ss}}{2} = \frac{1}{2} K_n' \left(\frac{w}{l} \right) (V_{gs} - V_t)^2$$

$$2 \times 10^{-3} = \frac{1}{2} \times 446.26 \times 10^{-6} \left(\frac{w}{0.12} \right) [1 - 0.754]^2$$

$$w_3 = 17.78 \mu m$$

IV. SIMULATION RESULTS

A. Transient Analysis

LO INPUT : SINUSODIAL 800MHz

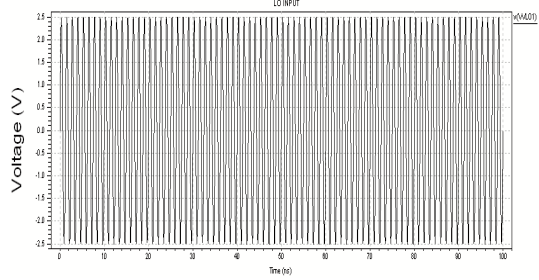

RF INPUT : SINUSODIAL 830MHz

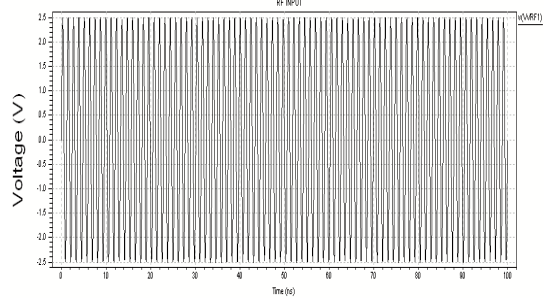

(i) IF OUTPUT : MODULATED SIGNAL

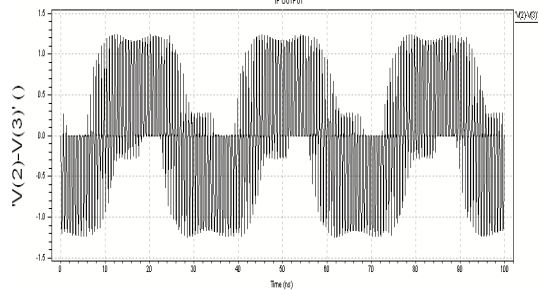

(ii.) IF Output after 2nd order LPF filter

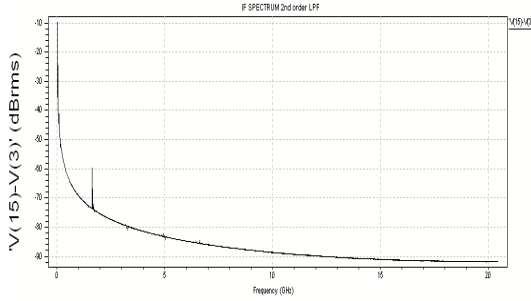

6.84	-0.354
7.6	0.34
7.853	0.668
7.889	0.644

B. Linearity Measurements:
Voltage Transfer Curve for Linearity :

(1). For Source Degeneration Resistor (Rs) = 25 Ω

dB(VVRF)	dB(VIF)
-0.445	-33.979
0	-27.95
1.583	-14.89
2.922	-8.404
4.082	-4.152
5.105	-2.158
6.02	-0.724
6.84	0.086
7.6	0.851
7.853	1.034
7.889	1.023

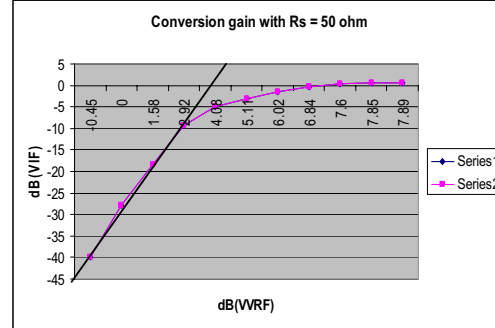

C. Noise Measurement:
Input - Output Noise Spectrum

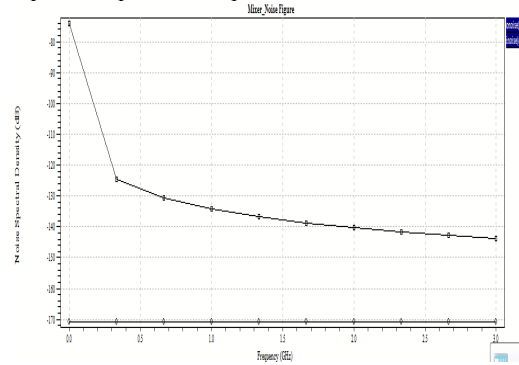

Noise Ratio Spectrum

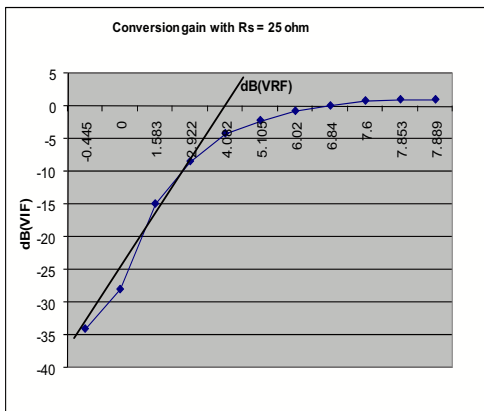
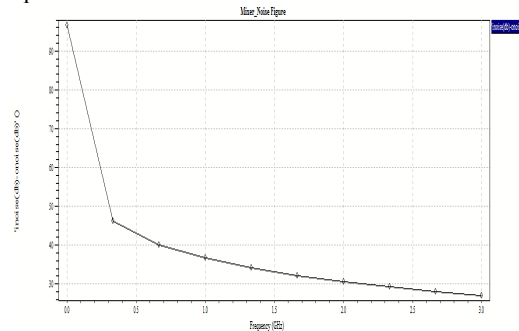

(ii). For Source degeneration Resistor(Rs) = 50 Ω

dB(VVRF)	dB(VIF)
-0.445	-40
0	-27.95
1.583	-18.41
2.922	-9.37
4.082	-5.036
5.105	-3.098
6.02	-1.514

D. Isolation:
RF to IF Isolation = 41 dB
LO to IF Isolation = 44 dB
LO to RF Isolation = 62 dB

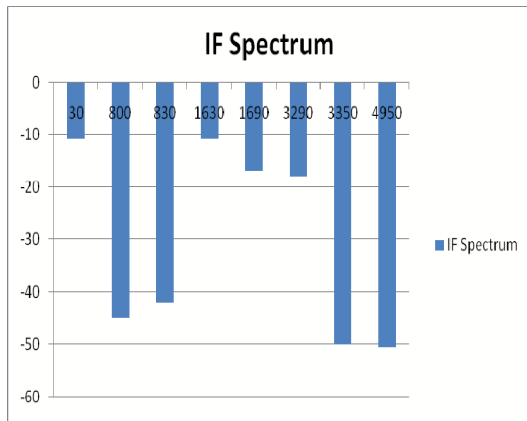

E. Power dissipation

Power Results

VDD from time 0 to 1e-007

Average power consumed -> **5.360484e-003 watts**

Max power 1.430878e-002 at time 5.45769e-008

Min power 1.062573e-004 at time 4.12254e-008

V. COMPARISON BETWEEN GILBERT CELL V/S SINGLE BALANCED MIXER

	Single balanced Mixer	Double balanced Mixer
Technology	0.12 um	0.12 um
Power Supply	2.5V	2.5V
Bias Current	4 mA	4 mA
Voltage conversion gain	6.46dB	6.51dB (Rs =25Ω)
1dB Compression Point	2.8dB	5.05dB
LO Power	-1.1dB	-1.1dB
LO to IF isolation	8.9dB	44dB
RF to IF isolation	48.9dB	41dB
LO to RF isolation	56.8dB	62dB
Power Dissipation	4.42 mW	5.36 mW
Chip area	89.445um ²	294.9 um ²

REFERENCES

- [1] Shaikh K. Alam and Joanne Degroat "A 2 GHz Highly Linear Downconversion Mixer in 0.18um CMOS", 12th NASA Symposium on VLSI Design, USA, Oct. 4-5, 2005
- [2] Stephen Long, "Designing an RFIC CMOS upconversion mixer".
- [3] Vikas Chandra, "A 2.5V High Linearity CMOS Mixer for 1.9 GHz Applications".
- [4] W. Cheng, C. Chan, C. Choy, and K. Pun. "A 1.2V 900 MHz CMOS Mixer". in *Proceedings of the IEEE International Symposium on Circuits and Systems*, 5:pp. 365-368, 2002.