

Estimating greenhouse gases emissions from large wastewater treatment plants using different methods - (Case study: Alexandria, Egypt)

Sara AbdelMoula ^{a)}, M. Tarek Sorour, Medhat Moustafa, and Mai Fayed

Alexandria University, Faculty of Engineering, Sanitary Engineering Department, Alexandria 21544, Egypt

Abstract—Egypt is a typical example of a developing country which is highly vulnerable to climate change. The weather patterns changes and the rise in seawater level in the Nile Delta are slow but the unremitting rate makes a difficult situation become worse, particularly in the area of food and water (Delta region). Egypt ranks the 94th in terms of per capita emissions with an average of 2.3 tons of CO₂ per person and 29th in the list of global polluters with 0.59% of global emissions. Estimating greenhouse gases emissions (GHGs) from wastewater treatment plants (WWTPs) is the first step to avoid the consequences of climate change and thus mitigating the quantity of GHGs. Therefore, an attempt was made in this study to estimate GHGs emissions from large WWTPs using two methods: IPCC, and USEPA, and then compare both with computer simulation program. In this study, GHGs emissions were estimated in the years 2018, and 2022 respectively for the case study (the Eastern Wastewater Treatment Plant in Alexandria, Egypt (EWWTP)) which is the second largest WWTP in Egypt. Results showed that: USEPA is the best method to estimate biogenic emissions in a country like Egypt and IPCC method is the best in energy emissions.

Keywords—Greenhouse gases, Climate change, CO₂ emission, N₂O emission, IPCC guidelines, EPA guidelines, Three Scopes method, Wastewater Treatment, Modeling, and simulation.

I. Introduction

In recent years, climate change and global warming have become important issues in the environmental sector because of their effects on the environment, economy and energy production. The present concern is the rapid increase in the concentration of gases such as CO₂, CH₄, and N₂O, which obstruct the radiation of heat from the Earth back into the atmosphere, resulting in Earth's surface increased temperatures. The international protocols and organizations have restricted greenhouse gases (GHGs) emissions, related regulations, obligatory limitations, carbon taxes, and penalties.^[1;2]

Egypt is a typical example of a developing country which is highly vulnerable to climate change. Sea Level Rise (SLR) is a devastating impact of climate change. 97% of Egyptians are living on the low lying coastal delta. A rise in sea levels would cause vast areas to be flooded (a third of the Nile Delta might be submerged by 2030) not only causing people to have

to move but also losing the fertile agricultural lands the people rely on for growing food.^[3]

According to the World Bank, climate change will cause inundation large areas of agriculture lands in Nile Delta and rising soil salinity due to Sea Level Rise (SLR) in addition to spreading insects and diseases due to high temperature these factors lead to reduced agricultural production by 8%.^[4]

Wastewater treatment plants (WWTPs) are considered sources of GHGs production. GHGs can be released to the atmosphere during wastewater treatment including carbon dioxide (CO₂) from aerobic processes, methane (CH₄) from anaerobic processes (5–19 % of global methane emissions), and nitrous oxide (N₂O) (3 % of N₂O emissions from all sources) related to nitrification and denitrification (NDN) processes, as an intermediate product.^[5]

There is a considerable benefit to determining carbon footprints of Wastewater Treatment Plants (WWTPs) with reference to greenhouse gas emissions, energy usage, energy production, and carbon credits. With a view to estimating GHGs emission in a wastewater treatment plant, an inventory of all GHGs emitted has to be conducted and the appropriate global warming potential (GWP) for each gas has to be applied. The GWP of GHGs is the ratio of heat trapped by one unit mass of the gas in a comparison with one unit mass of CO₂ over a specified time period as shown in Table 1 (typically 100 years) ^[6]

TABLE 1 Variations in the global warming potential of gases emitted from WWTPs; IPCC, 2014.

Gas	Chemical Name 2001 IPCC	GWP
Carbon Dioxide	CO ₂	1
Methane	CH ₄	23
Nitrous Oxide	N ₂ O	296

The first studies reporting GHGs emissions from wastewater treatment plants date back to the early 1990s and

was used on-site point measurements to quantify CO₂ and N₂O emissions from open basins in the wastewater treatment line.^[7]

Long-term investigations have been performed for enclosed treatment technologies with air collection systems to study daily and seasonal variations in GHGs emissions.^[8] Since the 1990s, GHGs emissions from wastewater treatment plants and biogas plants have been quantified, using ground-based remote sensing approaches. A Continuous Emission Monitoring System (CEM system) is the equipment necessary to determine CO₂. Nitrous oxide (N₂O) emissions can occur as direct emissions from treatment plants or from indirect emissions from wastewater after the disposal of effluent into lakes or the sea.^[9]

Most current theoretical and empirical methodologies of estimating GHGs emissions for WWTPs are based largely on the Intergovernmental Panel on Climate Change (IPCC) protocol established by the Intergovernmental Panel on Climate Change (IPCC). As the IPCC protocol was developed for ease of comparison of national GHGs emissions among countries including developing countries, this protocol provides a relatively simple, straightforward calculation method based on national human activity data and emission factors for estimating emission inventories.

More recently, the U.S. Environmental Protection Agency (USEPA) has adopted and modified the IPCC protocol and CO₂ can be estimated. This is because the USEPA believed that carbon from biogenic sources in aerated tanks may contribute to the greenhouse effect and that the reduction of carbon from sustainable sources may retard its emission cycle and even global warming. U.S. greenhouse gas emission inventories indicate that process-related GHGs emissions from wastewater treatment plants are on the order of 0.4% of the total U.S. emissions.^[10]

Currently, many modeling and simulation programs are used for estimating greenhouse gases, such as SIMBABIogas, BioWin Version 4.0 and GPS-X v.7. SIMBABIogas is a stand-alone simulation platform and replaces the biogas modeling of the software SIMBA 6.6, which requires the software Matlab Simulink from MathWorks Inc. The computer program GPS-X (v.7) software package (Hydromantis Inc., Ontario, Canada) is used to estimate energy and greenhouse gases emissions as a carbon footprint (CO₂eq) as a unit. This program uses Mantis3 model to estimate all the greenhouse gases emissions for any process in WWTP.

The ISO standard 14064, organize an entity's GHGs footprint into three categories of GHGs emission. Assessments of GHGs emissions generally divide facilities emissions into three areas or “scopes”:

(Scope 1- Emissions from WWTPs considering only organic matter biodegradation): This only considers emissions generated by biodegradation of organic matters by a microorganism and the production of CO₂, CH₄ and N₂O gaseous emissions in centralized wastewater treatment methods consist of a combination of biological processes (activated sludge reactors, trickling filters, anaerobic digesters, etc.). The nitrogen which is discharged with the

effluent causes N₂O emission regarding the occurrence of nitrification and denitrification in rivers and in estuaries.

(Scope 2- Emissions from WWTPs considering only energy used). This includes, for instance, the emissions of the power used for aeration, pumping, mixing, and heating. Scope 2 emissions are assessed by calculating a national average CO₂-equivalent emission factor per kilowatt generated because electricity is generally generated centrally.

(Scope 3- Emissions from WWTPs considering other indirect emissions). This includes, for instance, sludge digestion, sludge disposal, chemical use, and staff vehicles. Emissions in many methodologies are not calculated as part of a WWTP's carbon inventory.

Presently, there is no estimation of GHGs emissions in Egypt's wastewater treatment plants. Alexandria is Egypt's second largest city and a major economic center highly vulnerable to climate change. The estimation of GHGs emissions is the first step, thereby reducing greenhouse gases and thus protecting the city from climate change. Therefore, the main aim of this study is to estimate GHGs emissions from the Eastern wastewater treatment plant (EWWTP) using two methods: i) Intergovernmental Panel on Climate Change (IPCC), and ii) USEPA, and then compare both with computer simulation program (GPS-X 7.0).

II. Materials and Methods

A. Estimation procedure

The emissions of GHGs are estimated in three scopes. Scope 1 Emissions refer to “Direct GHGs emissions occur from sources that are owned or controlled by the company”. In Scope 1, it is assumed that GHGs emissions from primary and secondary clarification tanks are negligible.^[8] In this study, N₂O and CO₂ emissions are released from the EWWTP and there are not any CH₄ emissions. Scope 2 Emissions refer to “GHGs emissions from the generation of purchased electricity consumed by the company”. Scope 3 Emissions refer to emissions arising from activities outside of the direct operational control of the WWTP. For the purpose of the EWWTP (Case study), Scope 3 emissions cannot be estimated; therefore, total emissions are the sum of Scope 1 and Scope 2. The emissions in this study were estimated using the above two mentioned methods IPCC, and USEPA, and then compared with a computer simulation program (GPS-X 7.0).

1) Scope 1- IPCC method

The Intergovernmental Panel on Climate Change (IPCC) established guidelines for national GHGs inventories in 2006. In the IPCC Guidelines, Carbon dioxide (CO₂) emissions from wastewater are not considered because these are of biogenic origin and should not be included in national total emissions. N₂O emission is obtained through annual per capita protein consumption.^[9]

a) CO₂ estimation

Carbon dioxide (CO₂) emissions from WWTP's are not considered in the IPCC

b) N₂O estimation (from wastewater effluent)

$$N_2O \text{ Emissions} = N_{\text{EFFLUENT}} * EF_{\text{EFFLUENT}} * 44/28 \quad (1)$$

Where:

$$N_{\text{EFFLUENT}} = (P * P_{\text{PROTEIN}} * F_{\text{NPR}} * F_{\text{NON-CON}} * F_{\text{IND-COM}}) - N_{\text{SLUDGE}}$$

P = human population

P_{PROTEIN} = annual per capita protein consumption, kg/person/yr (91 g/person/d in Egypt; WHO, 2010)

F_{NPR} = fraction of nitrogen in protein, default = 0.16, kg N/kg protein

F_{NON-CON} = factor for non-consumed protein added to the wastewater (1.4 for developed countries using garbage disposals, while for developing countries this fraction is 1.1).

F_{IND-COM} = factor for the industrial and commercial co-discharged protein into the sewer system (default value is 1.25)

N_{SLUDGE} = nitrogen removed with sludge (default = zero), kg N/yr

EF_{EFFLUENT} = emission factor for N₂O emissions from discharged to wastewater, (0.005 (0.0005 - 0.25)) kg N₂O/kg N

44/28 = conversion of kg N₂O-N into kg N₂O.

2) Scope 1- USEPA method

The U.S. Environmental Protection Agency (USEPA) has adopted and modified the IPCC protocol and CO₂ can be estimated because USEPA believed that carbon from biogenic sources in aerated tanks may contribute to the greenhouse effect and that the reduction of carbon from sustainable sources may retard its emission cycle and even global warming.

a) CO₂ estimation

$$CO_2 = 10^{-6} * Q_{\text{WW}} * OD * E_{\text{ffOD}} * CF_{\text{CO}_2} * ((1 - MCF_{\text{WW}} * BG_{\text{CH}_4}) (1 - \lambda)) \quad (2)$$

Where:

10⁻⁶ = Units conversion factor (Mg/g)

Q_{WW} = Wastewater influent flow rate (m³/hr)

OD = Oxygen demand of influent wastewater to the biological treatment unit determined as either BOD₅ or COD (mg/L = g/m³)

E_{ffOD} = Oxygen demand removal efficiency of the biological treatment unit

CF_{CO₂} = Conversion factor for maximum CO₂ generation per unit of oxygen demand = 44/32 = 1.375 g CO₂/ g oxygen demand

MCF_{WW} = methane correction factor for wastewater treatment unit, indicating the fraction of the influent oxygen demand that is converted anaerobically in the wastewater treatment unit (in aerated treatment this factor is zero; USEPA draft, Dec 2010)

BG_{CH₄} = Fraction of carbon as CH₄ in generated biogas (default is 0.65)

λ = Biomass yield (g C converted to biomass/g C consumed in the wastewater treatment process)

b) N₂O estimation

$$N_2O_{\text{WWTP}} = Q_i * TKN_i * EF_{\text{N}_2\text{O}} * 44/28 * 10^{-6} \quad (3)$$

Where:

N₂O_{WWTP} = N₂O emissions generated from WWTP process (Mg N₂O/hr) (N₂O = 310 CO₂eq)

Q_i = Wastewater influent flow rate (m³/hr)

TKN_i = Amount of TKN in the influent (mg/L = g/m³)

EF_{N₂O} = N₂O emission factor (g N emitted as N₂O per g TKN in influent),

= 0.0050 g N emitted as N₂O/g TKN (Chandran, 2010)

44/28 = Molecular weight conversion, g N₂O per g N emitted as N₂O

10⁻⁶ = Units conversion factor (Mg/g).

3) Scope 2- IPCC method

CO₂ emissions from electricity use are estimated in the IPCC method by using the following equation:

$$ECO_2 = TE * EF_b \quad (4)$$

Where:

ECO₂ is the CO₂ emission from electricity use in the plants (kg CO₂)

TE is the total use of electricity in MWh

EF_b is the emission factor considered on the basis of generation of electricity (= 0.5 in Egypt, International Energy Agency (IEA 2010)).

4) Scope 2- USEPA method

The USEPA method uses the Avoided Emissions and Generation Tool (AVERT) to calculate energy emissions, U.S. national weighted average CO₂ marginal emission rate to convert reductions of kilowatt-hours into avoided units of carbon dioxide emissions. Estimation was provided a national marginal emissions factor for the Equivalencies. The emission factor does not include any greenhouse gases other than CO₂ or line losses.

$$(1,640.7 \text{ lbs. CO}_2/\text{MWh} \times (4.536 \times 10^{-4} \text{ metric tons/lb.}) \times 0.001 \text{ MWh/kWh} = 7.44 \times 10^{-4} \text{ metric tons CO}_2/\text{kWh})$$

5) Scopes 1 and 2- (GPS-X version 7.0) method

Simulation using (GPS-X 7) program was carried out for the case study. GPS-X v7.0 is used to estimate carbon footprint. (Mantis 3) is the appropriate model for the estimation of greenhouse gases. The program uses tCO₂eq/y as a unit and the method used is three scopes. GPS-X 7.0 estimates most emissions with details without much time-consuming. Model Calibration was conducted with the variables from influent advisor using (Mantis3).

B. Description of the Case Study

The Alexandria Eastern wastewater treatment plant (EWWTP), is the second largest wastewater treatment in Egypt, The outfall of the EWWTP is “Dayr Elmatar” drain. Eastern wastewater treatment plant treats an average flow of (650,000) m³/day of influent wastewater in the year 2018. The EWWTP consists of Inlet chambers which receive influent wastewater - mechanical screens and 10 grit removal chamber with capacity 320 m³; 16 circular primary settlers with capacity 3700 m³; and biological treatment (activated sludge process) with 12 aerated chambers using air diffusers with 10000 m³ capacity, the dimensions of each chamber is 40 m length by 40 m width - 24 final rectangular sedimentation tanks (5500m³). Figure 1 shows the EWWTP layout in GPS-X 7.0.

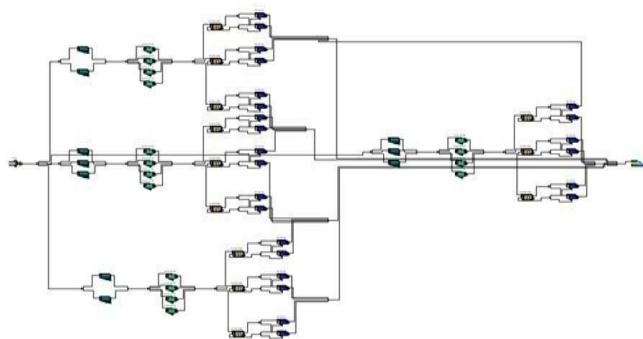

FIGURE 1 Case study layout in GPS-X 7.0 (EWWTP, year 2018).

The design capacity of the EWWTP is (825,000) m³/day till the year 2022. The effluent BOD, COD and TSS concentrations are accepted according to Egyptian code. In this study year, 2022 is used to study the effect of the increase in flow on the GHGs emissions.

III. Results

A. GPS-X 7.0 Model calibration and validation

Simulation using (GPS-X 7) program was carried out for the Alexandria, Egypt Eastern wastewater treatment plant (EWWTP) as a case study. Model Calibration was conducted with the variables from the influent advisor using (Mantis3) model. The simulation was conducted under influent concentrations as follows :(TKN = 40 gm/m³ - Ammonia = 30 gm/m³ - Liquid temperature = 20 C- MLSS = 2000 gm/m³ - Dissolved oxygen = 2 gm O₂/m³ - Sludge Age = 6 days - Under flow rate= 30 % - waste flow from final settler = 6000 m³/day). The importance of this step is to check the compatibility between the results in the laboratory to those calculated from the model for BOD₅, COD, and TSS to assure the reliability of the program as shown in Figure 2

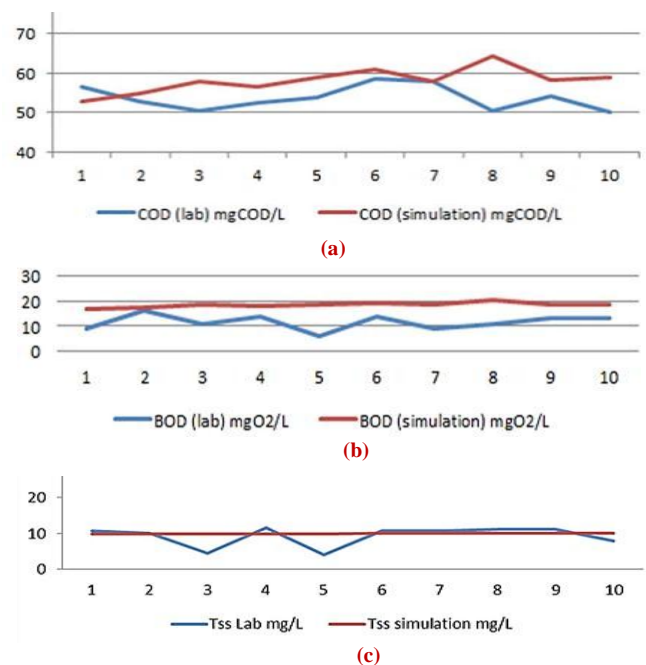

FIGURE 2 Case study verification in GPS-X 7.0 (EWWTP, year 2018) (a. COD verification – b. BOD verification – c. TSS verification).

B. Total emissions estimation

Scope 1 emission is the sum of CO₂ and N₂O for the case study. Total emissions are the sum of scope 1 and scope 2 emissions because scope 3 emissions are not considered in this study. All emissions are estimated in tCO₂eq/y as shown in Table 2

TABLE 2 Total emissions for (2018, 2022) using (IPCC, USEPA and GPS-X v. (7.0)) estimation methods in EWWTP (case study).

Year	Emission	IPCC	USEPA	GPS-X 7.0
2018	CO ₂	not considered	22658.2	10552.2
	N ₂ O	26158.6	18656.6	0.0
	Scope 1	26158.6	41314.8	10552.2
	Scope 2	6291.2	9361.26	6903.6
	Total	32449.8	50676.06	17455.8
2022	CO ₂	not considered	28758.44	10591.2
	N ₂ O	33362.35	23865.1	0.0
	Scope 1	33362.35	52623.54	10576.2
	Scope 2	6681	9941.4	6708
	Total	40043.35	62564.94	17284.2

iv. Discussion

GHGs emissions were estimated using two methods IPCC, and USEPA, and then both were compared with computer simulation program GPS-X 7.0 for two flow rates (2018, 2022), for Scope 1 emissions as shown in Figure 3, and for Scope 2 as shown in Figure 4. The total emissions are presented in Figure 5.

As stated before, CO₂ emissions are not considered in the IPCC method. In this study, CO₂ emissions were estimated using the USEPA method. As indicated in Table 2, the CO₂ emissions have a large value of about 22658.2 tCO₂eq/y in 2018, which increases by 26.9% with the increase of flow to reach a value of about 28758.44 tCO₂eq/y in 2022. CO₂ emissions were also estimated using the GPS-X 7.0 program; the simulation program gave lower values comparing with the USEPA. The estimated CO₂ emissions using simulation were found to be 10552.2 tCO₂eq/y, and 10591.2 tCO₂eq/y in years 2018 and 2022 respectively.

N₂O emissions in outfall (rivers, lakes...etc.) can be estimated using IPCC and USEPA methods. In the two flow rates 2018 and 2022, the occurrence of nitrification and denitrification in EWWTP outfall (“Dayr Elmatar” drain) causes N₂O emissions. There is no way to estimate N₂O emissions from outfalls in GPS-X 7.0 because the program estimates N₂O in nitrogen removal processes only. The estimation of GHGs emissions is not considered in the symbol of outfall in this program.

Using IPCC, the N₂O emissions are about 26158.6 tCO₂eq/y in 2018, which increase by 27.5% with the increase of flow to be about 28758.44 tCO₂eq/y in 2022. N₂O emissions were also estimated using the USEPA; lower values were estimated comparing with the IPCC. The estimated emissions using simulation were about 18656.6 tCO₂eq/y and 23865.1tCO₂eq/y in the years 2018 and 2022 respectively. In

IPCC, N₂O is estimated using single emission factors based on a limited data set that factor in protein intake and population but do not take into account different TKN conditions that estimate higher values of N₂O than USEPA which depends on the value of TKN of wastewater

Scope 1 value is the sum of CO₂ and N₂O for this case study. Scope 1 emissions from GPS-X 7.0 are smaller than other methods because N₂O emissions cannot be estimated. USEPA method estimates (scope 1) emissions about 41314.8 tCO₂eq/y and 52623.54 tCO₂eq/y in years 2018 and 2022 respectively. These values are higher than other methods values because both CO₂ and N₂O emissions are estimated using USEPA method.

For Scope 2 emissions, in this study, GPS-X 7.0 was set to an average of global value but higher values exist in the program and used for some states in the United States which are very close to the factors USEPA factors so that, GPS-X is closer to IPCC and USEPA is much higher. In IPCC and USEPA, 2022 scope 2 emissions were higher than 2018 emissions because of the increase in energy used with the increase of flow.

Total emissions in the USEPA were much higher than GPS-X 7.0 because USEPA is higher in scope 1 and scope 2. Total emissions of USEPA was the highest because of higher scope 1 and scope 2 emissions than other methods.

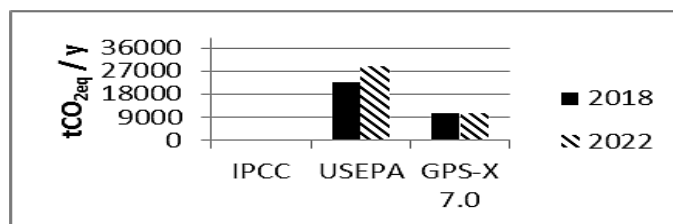

(a)

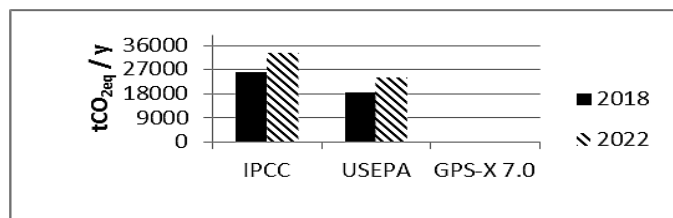

(b)

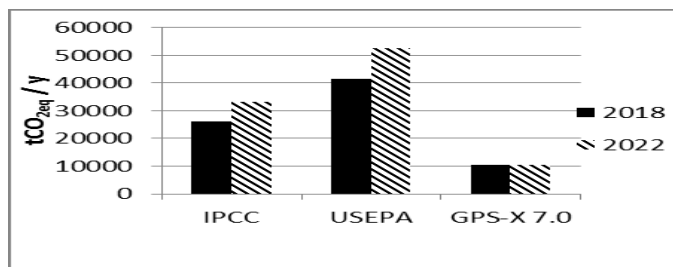

(c)

FIGURE 3 Scope 1 emissions for (year 2018 and 2022) using (IPCC, USEPA and GPS-X V (7.0)) estimation methods in EWWTP (case study) (a. CO₂ emissions – b. N₂O emission – c. Total emission of scope 1).

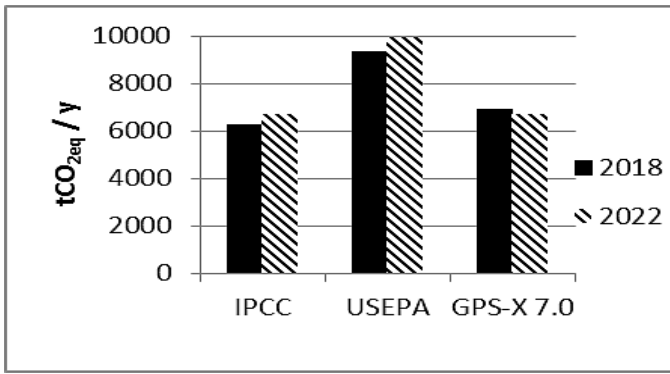

FIGURE 4 Scope 2 emissions for (2018, 2022) using (IPCC, USEPA and GPS-X V (7.0)) estimation methods in EWWTP (case study).

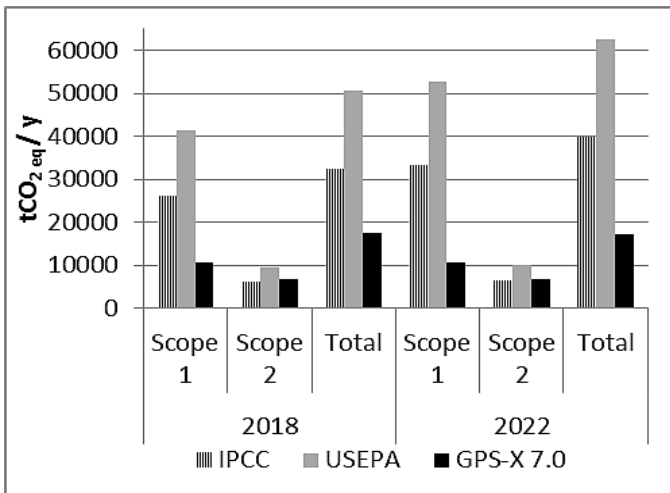

FIGURE 5 Total emissions for (a. 2018, 2022) using (IPCC, USEPA and GPS-X V (7.0)) estimation methods in EWWTP (case study).

v. Conclusion

It is believed that USEPA is the best method to estimate biogenic emissions in a country like Egypt because 1) CO₂ and N₂O biogenic emissions are included in the estimation and 2) N₂O emissions take into account different TKN conditions. IPCC method is the best in energy emissions in Egypt because it depends on the emission factor considered on the basis of generation of electricity which changes from one country to another. GPS-X 7.0 cannot be used with large layouts; it runs with a small number of units, and N₂O emissions cannot be estimated without nitrogen removal processes. That is why it is thought that GPS-X 7.0 is not suitable for plants with a large number of process units and where no nitrogen removal processes are included like EWWTP.

References

[1] IPCC (Intergovernmental Panel on Climate Change) Guidelines for national greenhouse gas inventories 2006. (<http://www.ipcc-nggip.iges.or.jp/public/2006gl/index.html>).

[2] UNFCCC (United Nations Framework Convention on Climate Change), December 2011 < <https://unfccc.int/durban-climate-change-conference-november/december-2011> >

[3] Smith J, McCarl B, Kirshen P and Jones R “Egypt’s economic vulnerability to climate change” Climate Research vol. 62, PP. (59-70),2014

[4] Abutaleb K., Mohammed A. and Ahmed M. “Climate Change Impacts, Vulnerabilities and Adaption Measures for Egypt’s Nile Delta” Earth Systems and Environment, Vol. 2, pp. (183–192), 2018

[5] Wang C., Lai D., Sardans J. and Wang W. “Factors Related with CH₄ and N₂O Emissions from a Paddy Field: Clues for Management implications” PLoS one, Vol. 12(1), p.e0169254, 2017

[6] Climate Change Synthesis Report. Contribution of Working Groups I, II and III to the Fifth Assessment Report of the Intergovernmental Panel on Climate Change, 2014

[7] Czepiel P, Crill P and Harriss R “Nitrous-oxide emissions from municipal waste-water treatment.” Environ. Sci. Technol.,vol., 29, PP. (2352–2356),1995

[8] Rodriguez-Caballero A., Aymericha I., Pochb M. and Pijuan M. “Evaluation of process conditions triggering emissions of greenhouse gases from a biological wastewater treatment system” Science of The Total Environment vol. 493, pp. 384-391, 2014

[9] Ramankutty N., Gibbs H., Achard F., DeFries, R. and Houghton, A. “Challenges to estimating carbon emissions from tropical deforestation” Global Change Biol vol.12, PP.(1–16), 2006.

[10] Research Triangle Institute” Greenhouse Gas Emissions Estimation Methodologies for Biogenic Emissions from Selected Source Categories: Solid Waste Disposal Wastewater Treatment Ethanol Fermentation”, U.S. Environmental Protection Agency Sector Policies and Programs Division Measurement Policy Group, December 14, 2010

[11] Giorgio M, Alida C, Riccardo G, Manel G, Reza S and Diego R “Greenhouse gas emissions from wastewater treatment plants on a plantwide scale: sensitivity and uncertainty Analysis” Environmental Engineering vol. 142, pp. (1-11), 2016

[12] Corominas L, Flores-Alsina X, Snip L and Vanrolleghem P “Comparison of different modeling approaches to better evaluate greenhouse gas emissions from whole wastewater treatment plants” Biotechnol. Bioeng. Vol.109, pp. (2854-2863), 2012

[13] Evans S, Deery S and Bionda J “How reliable are GHG combustion calculations and emission factors” 1st International Greenhouse Gas Measurement Symposium of the Air & Waste Management Association, San Francisco, March 22–24 2009

[14] Gupta D and Singh S “Greenhouse gas emissions from wastewater treatment plants: a case study of noida” Water Sustainability vol. 2, PP (131-139),2012

[15] Bridle T, Shaw A, Cooper S, Yap K, Third K and Domurad M “Estimation of greenhouse gas emissions from wastewater treatment plants” IWA World Water Congress, Vienna Austria, September 7-12 2008

[16] Ackerman K and Sundquist E “Comparison of two U.S. power-plant carbon dioxide emissions data sets” Environ. Sci. Technol, vol.42,PP (5688-5693),2008

About Author :



**Sara AbdelMoula AbdAllah, MSc.
Student**

*Department of sanitary engineering,
Faculty of Engineering,
Alexandria University, Egypt.*