

# Simulation Based Analysis of Resonant Behavior of Split-Ring Resonator Due to Flowing Polar Liquids

[Muhammad Muneeb Ul Hassan] [Tahir Ejaz] [Tahir Zaidi] [M. Haris Amir] [Sanaan Haider]

**Abstract**—In this research a novel mechanism is being presented which was devised to analyze the effects on resonant behavior of a non-planar split-ring resonator due to flowing polar liquids. Shifts in resonant behaviors have been observed when materials are placed in the gap of a split-ring resonator due to perturbation of electromagnetic fields. However, such study has been organized for materials under static conditions. For such study on liquids, these are contained in micro-capillary tubes and placed in resonator gap. Present work has been organized to perform sensitivity analysis of resonant behavior due to flowing polar liquids through resonator gap. For depicting flowing liquid through a micro-capillary tube, different column lengths of liquids (inside the tube) were placed in resonator gap. Effects of flow, liquid placed at various points, were then analyzed for shifts in the quality factor and resonant frequency of the split-ring resonator. Simulations were organized for dimethyl sulphoxide, methanol and distilled water. Results and analysis have been presented for this study.

**Keywords**—Micro-capillary tube, perturbation, sensitivity analysis, split-ring resonator

## I. Introduction

Microwave resonators are used as major component in various electrical and electronic circuits. Their utilization can also be found in industrial applications requiring synthesizing process of fertilizer, chemical, pharmaceutical and food industries. In these applications information about molecular structure of materials, presence of foreign particles, the determination of water content and composition of materials are obtained. All these applications are majorly based upon resonators' ability in analysis of molecular structure and composition of materials [1], [2].

To explore composition and characterization of polar materials, two microwave techniques are majorly used i.e. resonant and non-resonant techniques. These techniques offer

dielectric properties of material in different ways. The earlier provides dielectric properties at a single or several discrete frequencies [3] while the later provides information about the electromagnetic properties over a range i.e. broadband frequencies [4]. Resonant methods are based on perturbation technique and utilize different types of resonant structures. Whereas, non-resonant methods mainly consist of reflection and transmission techniques [5].

Resonant techniques are considered as more precise and accurate. Information about molecular structure and composition of materials and their behavior in electromagnetic environment is obtained by studying their resonant behavior and hence the permittivity of sample materials [1], [2], [6]. Split-ring resonator (SRR) has been effectively utilized in resonant base applications. This type of resonator is characterized with moderate quality factor, lower phase noise, ease of fabrication and low cost etc. [4]. SRR has been successfully used for analysis of polar liquids and detection of compositional variations in the mixtures of polar liquids [5].

In resonant technique, which is discussed in this paper, a material under test (MUT) is introduced inside the gap of SRR as shown in Fig. 1. For characterizing liquids under stationary condition, they are contained in a micro-capillary tube and placed in resonator gap. Introduction of the material in gap causes the electromagnetic properties of the system to change [7]. These changes are observed as shift in the quality (Q) factor and resonant frequency  $f_r$  [8]. These resonant parameters have been modeled using different relations since the recognition [9], [10]. Following relations are used for the calculation of  $f_r$  and Q by using MATLAB.

$$f_r = \frac{c}{2\pi r_0} \sqrt{\frac{t}{\pi W}} \sqrt{1 + \frac{r_0^2}{R_0^2 + (r_0 + W)^2}} \quad (1)$$

Where  $c$  is the speed of light,  $t$  is the gap of SRR,  $W$  is the width of resonator,  $r_0$  is inner radius of resonator and  $R_0$  is radius of the shield. Q factor is calculated by following relation:

$$Q = \frac{r_0}{\delta} \frac{1 + \frac{r_0^2}{R_0^2 - (r_0 + W)^2}}{1 + (1 + \frac{W}{r_0} + \frac{R_0}{r_0}) (\frac{r_0^2}{R_0^2 - (r_0 + W)^2})^2} \quad (2)$$

Where  $\delta$  is the depth of the resonator material and it can be represented as:

$$\delta = \sqrt{\frac{2\rho}{\omega_0 \mu_0}} \quad (3)$$

Muhammad Muneeb Ul Hassan (Author)  
 National University of  
 Sciences and Technology,  
 Pakistan

Tahir Ejaz (Author)  
 HITEC University,  
 Pakistan

Tahir Zaidi (Author)  
 National University of  
 Sciences and Technology,  
 Pakistan

M. Haris Amir (Author)  
 Aston University,  
 Birmingham,  
 United Kingdom

Sanaan Haider (Author)  
 National University of  
 Sciences and Technology,  
 Pakistan

Where  $\omega_0$  is the resonant frequency,  $\mu_0$  is permeability of free space and  $\rho$  is the resonator material's conductivity.

In this work resonant behavior of SRR has been studied due of flowing liquid. This novel idea required a new mechanism for study and analysis. Flowing liquid was simulated with the help of High Frequency Simulator. To simulate the liquid in flowing condition, Optimetrics feature of the software was utilized. The micro-capillary tube was divided into several equal portions through parametric setup. Then the liquid in flowing condition was simulated by filling portions of micro-capillary tube from top to bottom gradually. And eventually, the liquid's exit was simulated by emptying the portions of micro-capillary tube from top to bottom gradually with the help of parametric setups.

## II. Theory

SRR is described as a lumped-element device that can be validated using LC circuit. A simple structure for SRR is presented in Fig. 1. Metallic cylindrical loop acts as an inductor while the longitudinal gap as a capacitor [9], [11]. Magnetic field (H) is surrounding the loop while the electric field (E) is induced in the gap of the resonator [10]. Resonant frequency of this LC circuit can be mathematically represented as:

$$f_r = \frac{1}{2\pi\sqrt{LC}} \quad (4)$$

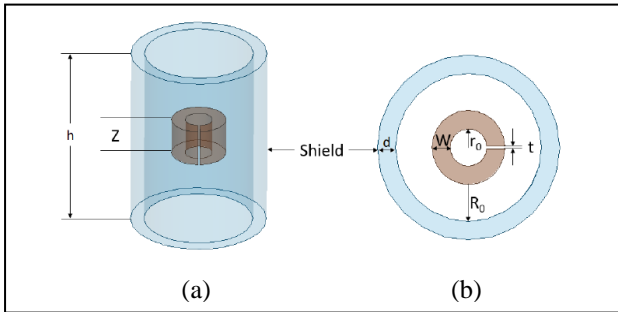

Figure 1. A Split Ring Resonator Structure (a). Design of a Split Ring Resonator enclosed within metal shield cavity (b). Cross-sectional observation of SRR inside the shield cavity.

In above relation, L symbolizes the overall inductance while C is for the overall capacitance. Similarly, the quality factor is mathematically represented as:

$$Q = \frac{\omega}{\Delta\omega} = \frac{f_r}{\Delta f_r} \quad (5)$$

Split ring resonator is confined inside a metallic shield cavity for the prevention of excessive radiation loss,

which helps in maintaining high quality factor Q for microwave frequencies. Shield also protects the resonator from external interference [12].

When a small amount of a dielectric material/liquid, possessing some relative permittivity, is placed in resonator gap, it causes perturbation in electromagnetic field. This causes shifts in both aforementioned resonant parameters. Resonant parameters  $f_r$  and Q are related with dielectric properties by the following relations [9]. Where  $\epsilon_r'$  is the real part of relative permittivity while  $\epsilon_r''$  is the imaginary part of permittivity.

$$\epsilon_r' \propto \Delta f_r \quad (6)$$

$$\epsilon_r'' \propto \Delta\left(\frac{1}{Q}\right) \quad (7)$$

## III. Methodology and Simulation

Initially, an arbitrary structure was designed and simulated in High Frequency Simulator [11]. Copper was used for SRR due to high conductivity while aluminum for shield because of its low tangent and high quality factor [8]. Resonant structure with a resonant frequency of about 2.5 GHz and Q factor around 3000 was considered feasible for this work. To fulfil the feasibility criteria; height, thickness and inner radii of outer shield and SRR were varied in the arbitrary designed SRR [13], [14]. A design was finalized which met these criterion through optimetrics feature of the software. Dimensions for the finalized simulated model are illustrated in Table I.

TABLE I: PARAMETERS OF THE OPTIMIZED SRR

Design Factors	Values (mm)
Inner Radius ' $R_0$ ' of the Outer Shield	28
Inner Radius ' $r_0$ ' of SRR	5
Width ' $W$ ' of SRR	4
Gap of Split-ring resonator ' $t$ '	2
Height ' $h$ ' of Shield	30
Thickness ' $d$ ' of the Outer Shield	10

A micro-capillary tube with both ends open was selected to analyze the flow of polar liquids. Micro-capillary tube (open on both ends), carrying liquids, can be introduced either perpendicular or parallel to the electric field inside the cavity split which eventually interrupts properties of the system [15]. For present work, it was inserted from top of the shield, entered vertically into the gap of SRR and it passed through the bottom of the shield to carry the liquids into the sink. The model designed using above dimensions (without sample) is shown in Figure 2.

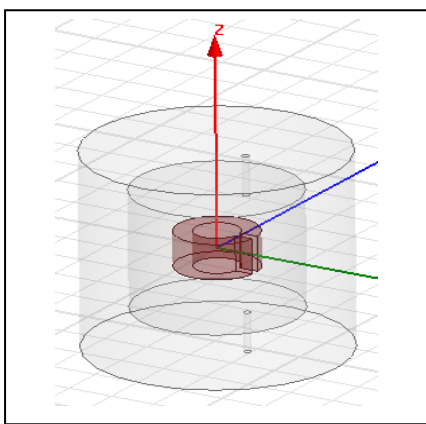

Figure 2. Simulated model of SRR without sample

The designed structure, with and without tube, was analyzed in High Frequency Simulator. Obtained values for resonant parameters of designed structure for empty cavity and without tube are given in Table II.

TABLE II. RESONANT PARAMETERS

State of the Design	Resonant Frequency (GHz)	Q Factor
Empty Cavity	2.58	3170.357
Without tube	2.48	2800.181

For studying effects on resonant parameters of SRR due to flowing liquid, three polar liquids were used. These included dimethyl sulphoxide (DMSO), methanol and distilled water. These liquids were simulated flowing from top of the micro-capillary tube, which was placed in resonator gap. These liquids were injected into the tube separately for analysis. Liquids passed through the gap of the split-ring resonator and exited through the bottom (illustrated in Figure 3). The entire length of micro-capillary tube was divided into six equal portions by applying optimetric and parametric setups. Micro-capillary tube portions namely “liquid entering the SRR gap”, “SRR gap completely filled with liquid” and “liquid exiting the SRR gap”, are of major interest. So, we shall discuss the results of only these three portions of micro-capillary tube. These parametric setups were applied to analyze effects of the flow of liquids at above stated three portions. In order to simulate flowing liquid, each liquid was initially contained in top first portion of micro-capillary. The liquid then occupied top two portions. In this manner liquid successively occupied all the six portions. Once the liquid completely filled the micro-capillary tube, its exit was simulated by emptying portions of tube from top to bottom in a similar manner.

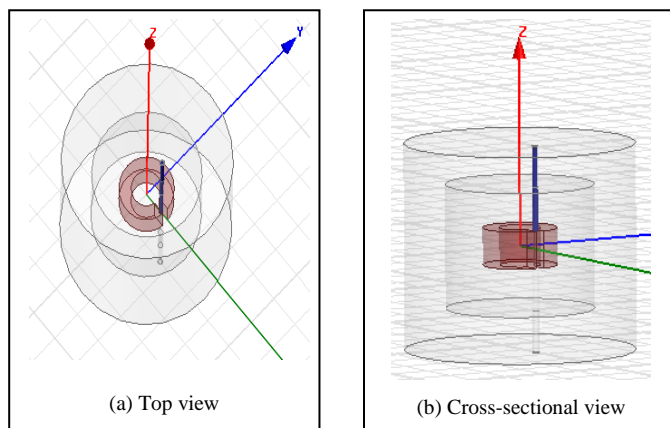

Figure 3. Simulated model of Split Ring Resonator with sample flowing through the micro-capillary tube

#### iv. Analysis and Discussion

Flowing DMSO was analyzed first, which was followed by methanol and distilled water. Resonant parameters of SRR for the three flowing liquids were obtained through simulations. It was noticed that when the liquids began to enter the vicinity of resonator gap (as shown in Figure 3), a significant shift was observed in both resonant parameters, i.e., ' $f_r$ ' and 'Q'. The values obtained for resonant parameters pertaining to the liquid flowing through different portions of micro-capillary tube are provided in Table III and graphical representation is in Figure 4.

TABLE III. SIMULATION RESULTS FOR DIMETHYL SULPHOXIDE (FLOWING THROUGH SRR GAP)

Liquid position while flowing through micro-capillary tube	Resonant Frequency $f_r$ (GHz)	Shift in Resonant Frequency $\Delta f_r$ (GHz)	Q Factor	Shift in Q Factor $\Delta Q$
Liquid entering the SRR gap	2.051	0.531	440.61	2729.75
SRR gap completely filled with liquid	2.602	0.021	3286.5	116.07
Liquid exiting the SRR gap	2.094	0.487	426.24	2744.13

It is evident from Table III, that shift in resonant frequency and Q factor gradually increases as DMSO enters the gap of the resonator. While the change gradually dampens as the liquid exits the resonator gap and micro-capillary tube.

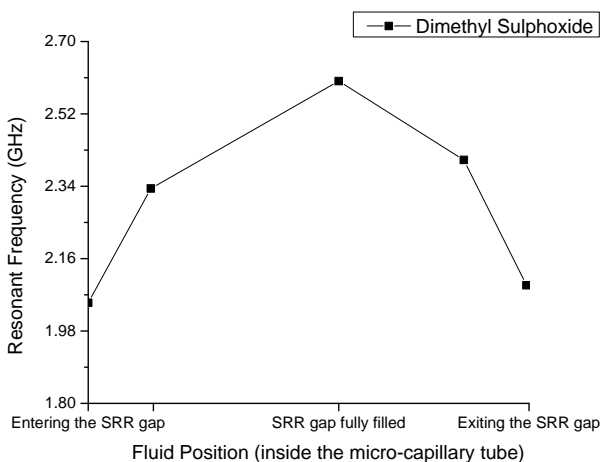

Figure 4(a). Resonant frequency as a function of liquid movement

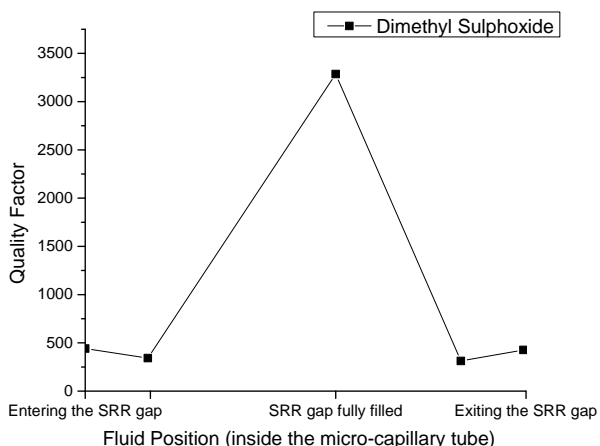

Figure 4(b). Quality Factor as a function of liquid movement

Figure 4. Resonant Parameters as a function of the liquid movement (inside the micro-capillary tube) for dimethyl sulphoxide

The second parametric setup was run for methanol. Same schematics were applied, where the micro-capillary tube was divided into six equal portions. The results attained are illustrated in Table IV and graphical representation is in Figure 5.

TABLE IV. SIMULATION RESULTS FOR METHANOL (FLOWING THROUGH SRR GAP)

Liquid position while flowing through micro-capillary tube	Resonant Frequency $f_r$ (GHz)	Shift in Resonant Frequency $\Delta f_r$ (GHz)	Q Factor	Shift in Q Factor $\Delta Q$
Liquid entering the SRR gap	2.077	0.504	433.86	2736.5
SRR gap completely filled with liquid	2.609	0.029	3295.2	124.84
Liquid exiting	2.124	0.457	416.03	2754.4

the SRR gap			
-------------	--	--	--

As apparent from Table IV, the shift in resonant frequency and Q factor is increasing as methanol enters the vicinity of the resonator i.e. gap of the resonator. It gives the most significant values for shift in both resonant parameters as methanol occupies the resonator gap completely. The values for shift in resonant parameters are less significant when the liquid exits the gap of the resonator through bottom of micro-capillary tube. Graphical representation of attained results is demonstrated in Figure 5.

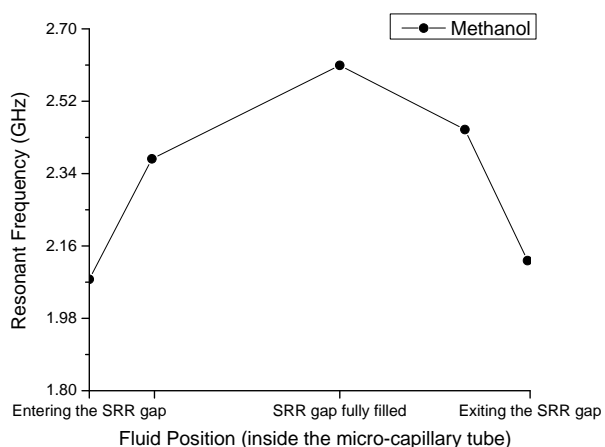

Figure 5(a). Resonant frequency as a function of liquid movement

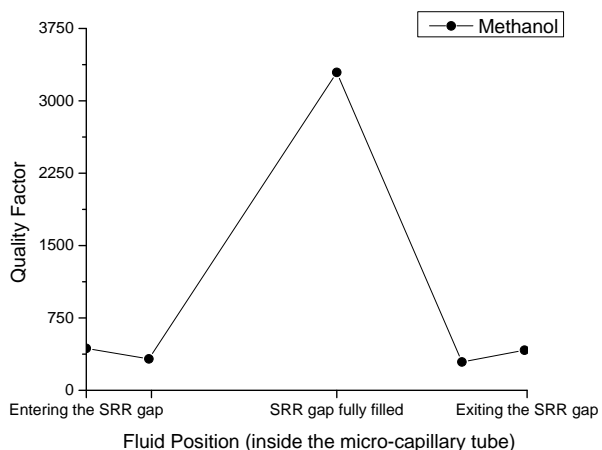

Figure 5(b). Q Factor as a function of liquid movement

Figure 5. Resonant parameters as a function of liquid movement (inside the micro-capillary tube)

At the end, distilled water was used in the micro-capillary tube by using similar optometric and parametric setups. Simulations results are listed in Table V and graphically illustrated in Figure 6.

TABLE V. SIMULATION RESULTS FOR DISTILLED WATER (FLOWING THROUGH SRR GAP)

Liquid position while flowing through micro-capillary tube	Resonant Frequency $f_r$ (GHz)	Shift in Resonant Frequency $\Delta f_r$ (GHz)	Q Factor	Shift in Q Factor $\Delta Q$
Liquid entering the SRR gap	1.973	0.608	455.74	2714.62
SRR gap completely filled with liquid	2.595	0.015	3271.4	100.96
Liquid exiting the SRR gap	2.033	0.548	445.95	2724.41

It is observed from Table V, that the shift in  $f_r$  and Q factor is gradually increasing as water enters and flows through the gap of the resonator. Shift in both resonant parameters is maximum as the liquid passes through the middle of the SRR gap and occupies the SRR gap completely. A drop was witnessed in resonant parameters' shift as the liquid began to exit the gap of the resonator. The results obtained are graphically demonstrated in Figure 6.

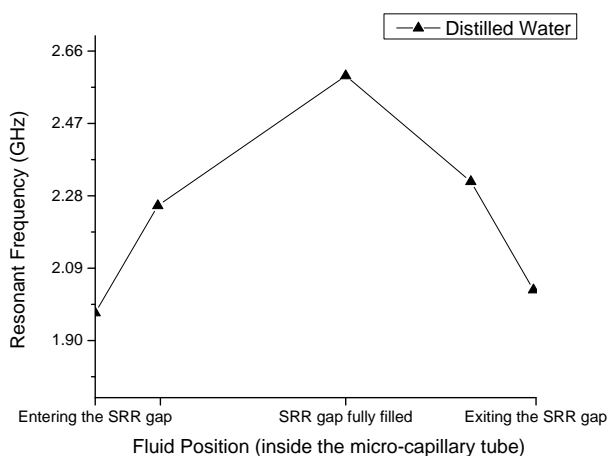

Figure 6(a). Resonant frequency as a function of liquid movement

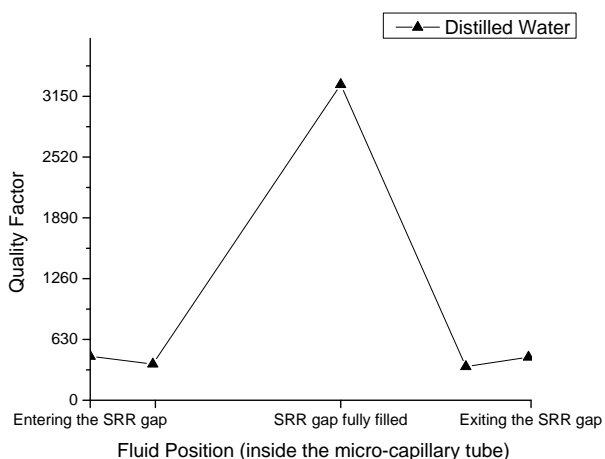

Figure 6(b). Q Factor as a function of liquid movement

Figure 6. Resonant Parameters as a function of the liquid movement (inside the micro-capillary tube) for distilled water

Comparison of the results attained from analysis of dimethyl sulphoxide (DMSO), methanol and distilled water is graphically represented in Figure 7.

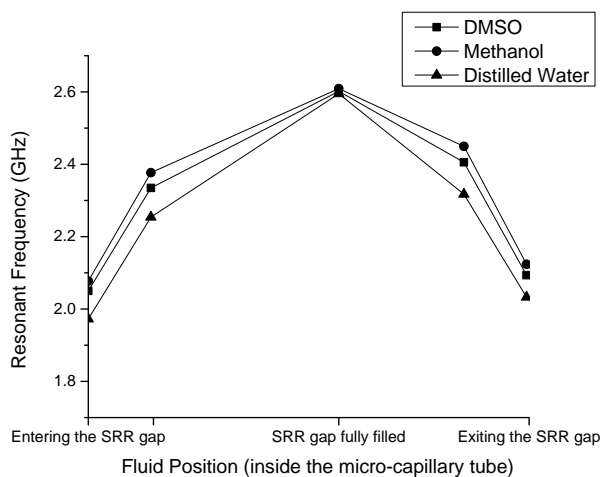

Figure 7(a). Resonant frequency as a function of liquid movement

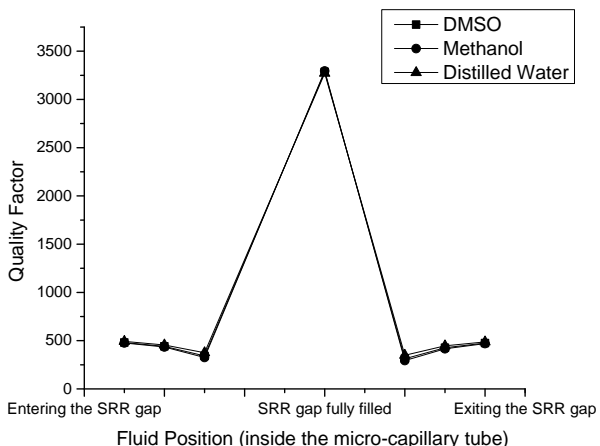

Figure 7(b). Quality Factor as a function of liquid movement

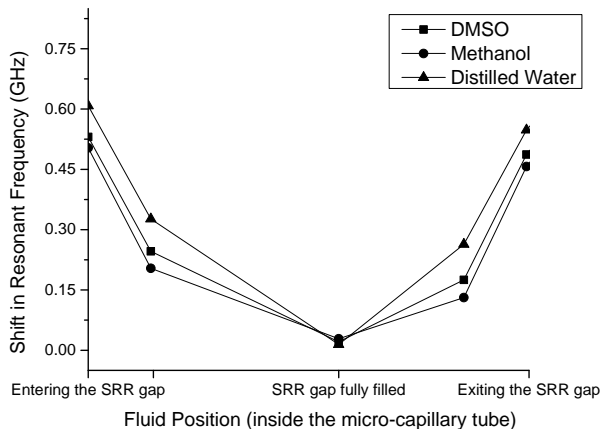

Figure 7(c). Shift in Resonant Frequency as a function of liquid movement

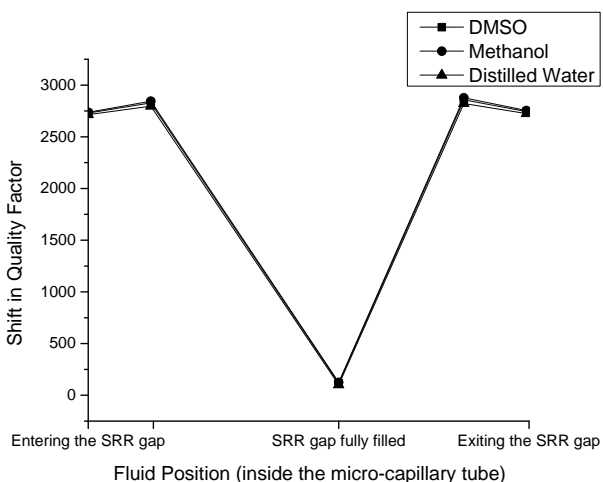

Figure 7(d). Shift in Quality factor as a function of liquid movement

Figure 7. Comparison of resonant parameters as a function of liquid movement (inside the micro-capillary tube) for dimethyl sulphoxide, methanol and distilled water

It can be observed that changes in resonant parameters i.e.,  $f_r$  and  $Q$  are of higher order for methanol than DMSO and distilled water at relative positions of micro-capillary tube. Whereas, the changes in resonant frequency and quality factor for distilled water are of lower order than both DMSO and methanol at relative positions inside the micro-capillary tube while flowing through the SRR gap. And the shift in both the resonant parameters for DMSO is intermediate among distilled water and methanol at relative positions of micro-capillary while flowing through the SRR gap. The difference can be explained in terms of properties of liquids like viscosity, loss tangent etc.

## v. Conclusion

In this paper, a simulation based sensitivity analysis has been presented for three different polar liquids flowing

through the gap of the SRR. To obtain values of shift in the resonant frequency and  $Q$  factor, analysis was carried out for liquids flowing at different positions inside the micro-capillary tube. Simulation results demonstrate that shifts in resonant parameters and  $Q$  factor is more significant when the liquid is flowing through the center of the SRR split. Comparison amongst the effects of three polar liquids depict that viscosity influences the flowing rate of the liquids. As, methanol is the least viscous among dimethyl sulphoxide and distilled water and it has the least value of relative permittivity. Hence, the shift in resonant frequency and  $Q$  factor is the highest for methanol. Whereas, distilled water has the highest relative permittivity value amongst the three liquids, and it demonstrates the least shift in resonant frequency and  $Q$  factor. Research made in this paper provides guidelines for analyzing effects of flowing polar liquids through gap of SRR.

## References

- [1] Sharma, M., R. Resta, and R. Car, Dipolar correlations and the dielectric permittivity of water. *Physical review letters*, 2007. **98**(24): p. 247401.
- [2] Halik, M., et al., Relationship between molecular structure and electrical performance of oligothiophene organic thin film transistors. *Advanced Materials*, 2003. **15**(11): p. 917-922.
- [3] Rowe, D.J., et al., Improved split-ring resonator for microfluidic sensing. *IEEE Transactions on Microwave Theory and Techniques*, 2014. **62**(3): p. 689-699.
- [4] Schönhals, A. and F. Kremer, Broadband Dielectric Measurement Techniques (10-6 Hz to 1012 Hz), in *Broadband Dielectric Spectroscopy*. 2003, Springer. p. 35-57.
- [5] Tereshchenko, O., F.J.K. Buesink, and F.B.J. Leferink. An overview of the techniques for measuring the dielectric properties of materials. in *General Assembly and Scientific Symposium, 2011 XXXth URSI*. 2011. IEEE.
- [6] Nelson, S.O., Dielectric properties of agricultural products-measurements and applications. *IEEE transactions on Electrical Insulation*, 1991. **26**(5): p. 845-869.
- [7] Pereda, J., et al., Computation of resonant frequencies and quality factors of open dielectric resonators by a combination of the finite-difference time-domain(FDTD) and Prony's methods. *IEEE microwave and guided wave letters*, 1992. **2**(11): p. 431-433.
- [8] Cho, S.-Y., I.-T. Kim, and K.S. Hong, Microwave dielectric properties and applications of rare-earth aluminates. *Journal of materials research*, 1999. **14**(1): p. 114-119.
- [9] Hayat, T., et al. Simulation Based Comparative Analysis of Split Resonators for Compositional Analysis. in *The Fourth International Conference on Technological Advances in Electrical, Electronics and Computer Engineering (TAECE2016)*. 2016.
- [10] Mehdizadeh, M. and T.K. Ishii, Electromagnetic field analysis and calculation of the resonance characteristics of the loop-gap resonator. *IEEE Transactions on Microwave Theory and Techniques*, 1989. **37**(7): p. 1113-1118.
- [11] Amir, M.H., et al., Simulation Based Sensitivity Analysis of Split Ring Resonator for Detecting Compositional Variations in Mixture of Polar Liquids.
- [12] Ejaz, T., et al., Shield optimization and formulation of regression equations for split-ring resonator. *Mathematical Problems in Engineering*, 2016. **2016**.
- [13] Ejaz, T., et al. A comparative analysis of split-ring resonator models. in *Proceedings of the 4th International Conference on Informatics, Electronics & Vision (ICIEV'15)*. 2015.
- [14] Gregory, A.P. and R. Clarke, Tables of the complex permittivity of dielectric reference liquids at frequencies up to 5 GHz. 2001: National Physical Laboratory Teddington.

[15] Chen, L.-F., et al., Microwave electronics: measurement and materials characterization. 2004: John Wiley & Sons.

About Authors:



**Muhammad Muneeb Ul Hassan** received his B.Sc. degree in Electrical Engineering from University of Engineering & Technology, Taxila, Pakistan. At present, he is pursuing his Masters in Electrical Engineering from College of Electrical and Mechanical Engineering, National University of Sciences and Technology, Islamabad, Pakistan. His area of research is microwave resonators.

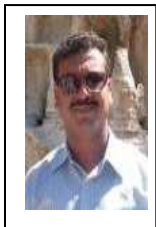

**Tahir Ejaz** received his Ph.D. from College of Electrical and Mechanical Engineering, National University of Sciences and Technology, Islamabad, Pakistan in Electrical Engineering. He is currently working on microwave resonators based characterization of materials.



**Tahir Zaidi** received his Ph.D. in computer semiconductors from Georgia Institute of Technology, School of Electrical and Computer Engineering, USA in 2010. At present, he is serving as Professor at College of Electrical and Mechanical Engineering, National University of Sciences and Technology, Islamabad, Pakistan in Electrical Engineering Department.



**M. Haris Amir** received his B.Sc Electrical Engineering degree from Air University, Islamabad, Pakistan. And he completed his Masters in Electrical Engineering from College of Electrical and Mechanical Engineering, National University of Sciences and Technology, Islamabad, Pakistan. His area of research is Microwave Resonators.  
\* Now with Aston University, United Kingdom.



**Sanaan Haider** received his B.Sc Electrical Engineering degree from Air University, Islamabad, Pakistan in 2014. Recently, he is pursuing his Masters in Electrical Engineering from College of Electrical and Mechanical Engineering, National University of Sciences and Technology, Islamabad, Pakistan. His current area of learning is characterization of materials using resonators.