

Joint Distance and Azimuth Angle estimation using an UWB-based Indoor Localization System

Nour Awarkeh, Jean-Christophe Cousin, Muriel Muller and Nel Samama

Abstract—This paper presents a ranging test conducted in a standard indoor environment using an ultra-wideband (UWB) radar system. The position is determined by jointly estimating the distance using the Energy Detection (ED) method, and the Azimuth angle using Phase Correlation (PC) method. The obtained results show that this UWB ranging system can improve the angular resolution compared to traditional Indoor Localization Systems (ILSs).

Keywords—indoor localization, UWB, phase correlation, energy detection, azimuth angle.

I. Introduction

The location data of a user or device in a given space appeared a few years ago and has since become an essential element of contextual information. For this reason, indoor localization has lately gained interest due to the vast range of services it can offer in many areas and applications. Many positioning technologies can be used within an Indoor Localization System (ILS) depending on the intended accuracy, resolution, precision, cost, etc [1]. Prior work includes GPS [2], Infrared [3], Ultrasonic [4], WiFi [5], Bluetooth [6], RFID [7] and UWB [8].

Ultra Wide Band (UWB) technology is a great option for ILS and has many advantages over traditional narrow-band systems, such as high penetration power, low energy consumption, resistance to multi-path effects, high security, low complexity, very precise positioning, etc.

During the past decade, extensive research efforts have been focused on analyzing the performance of ILS. In [9] and [10], various Time-of-Arrival (ToA) estimation algorithms for low sampling rate UWB systems based on Energy Detection (ED) are analyzed. In [11], a ranging experiment in a typical indoor environment with a digital UWB system is performed, where the ToA estimation algorithm is based on ED method. In [12], the performance of ToA position estimation techniques as well as the simulated and measured performances of an Impulse Radio (IR)-UWB non-coherent energy-collection receiver are examined.

While the above contributions based on ED method could accurately locate an Active Tag (AT) in different setups, they

cannot estimate its position when it is close to the orthogonal axis to the baseline of the ILS. One way to overcome this problem is using the Phase Correlation (PC) method, already applied for Continuous Wave (CW) signals [13]. Yet, the accuracy of this solution is severely affected by the multipaths environment, even in Line-of-Sight (LoS) situations. Therefore, in order to address this critical problem, we propose in this paper to adapt the PC method to UWB signal.

The remainder of the paper is organized as follows. In Section II, we describe the topology of the localization system as well as the proposed localization method. In Section III, we present the measurement system setup and the respective results. Finally, concluding remarks are drawn in Section IV.

II. Localization System Architecture

We consider the 2D ILS shown in Fig.1 where a Localization Base Station (LBS) is used to locate an AT by jointly estimating the radial distance and Azimuth angle. In the sequel, we describe the architecture of the considered ILS and its UWB hardware, as well as the corresponding localization method.

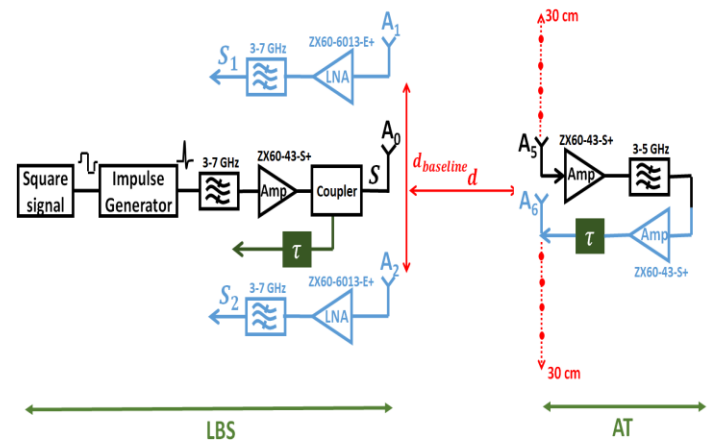

Figure 1. Architecture of the localization system

A. 2D Localization System Design

The LBS is composed by one RF transmitter chain linked to antenna A_0 , and two RF receiver chains, connected to antennas A_1 and A_2 . The three antennas are aligned and A_0 is placed in the center of $d_{baseline}$ formed by the antennas A_1 and A_2 .

The AT includes a receiving antenna A_5 and a transmitting antenna A_6 connected via a Low Noise Amplifier (LNA) and a

Nour Awarkeh and Jean-Christophe Cousin
 Télécom Paris
 France

Muriel Muller and Nel Samama
 Télécom SudParis
 France

delay line τ . A_5 and A_6 are close to each other and placed vertically on the same support. The known delay τ is used mainly to segregate the LBS signal from the backscattered signals of an indoor environment, taking advantage of the different arrival times between them. This approach is also adopted in the ground stations of Distance Measuring Equipment (DME) systems dedicated for the aerial navigation [14]. The delay τ is fixed depending on the desired maximal range. In this work, τ is chosen to be longer than the time needed for a round trip flight of the wave.

This setup starts by sending UWB pulses via A_0 . At the tag side, this signal is received by A_5 and then re-transmitted by A_6 to the LBS, after adding a delay τ to it.

B. UWB Hardware

The transmitter chain consists of a squared signal generator connected to an impulse generator. In order to optimize the useful energy of the pulse in the bandwidth of A_0 , the UWB pulse has been filtered by a Band-Pass Filter (BPF) and next amplified by a LNA, before being transmitted by A_0 .

At the AT level, the received signal by A_5 is first amplified using a LNA and then filtered out with a BPF. After a second amplification using the same component, the signal is shifted by the delay τ and finally re-transmitted by A_6 towards the LBS.

The receiver chains capture the re-transmitted signal from the AT using the two antennas (A_1 and A_2) of the LBS. The received signals are amplified using a wideband LNA and then filtered by a BPF. At this point, the emitted signal (S) is shifted by the same delay τ applied at the AT to compensate for the delay added in the AT and to exclude the effect of the antenna coupling. Next, the received signals (S_1 and S_2) and the delayed emitted signal are sampled using an oscilloscope to perform digital processing.

C. Localization method

The ILS system is used then to estimate the radial distance d and the Azimuth angle α of the AT, as shown in Fig. 2.

The radial distances d_1 and d_2 between the LBS and the AT are obtained by estimating the absolute time of arrival (ToA) of the received signals (S_1 and S_2). The azimuth angle α can be estimated by computing the time difference of arrival (TDoA) Δt between the two received signals (S_1 and S_2) [15].

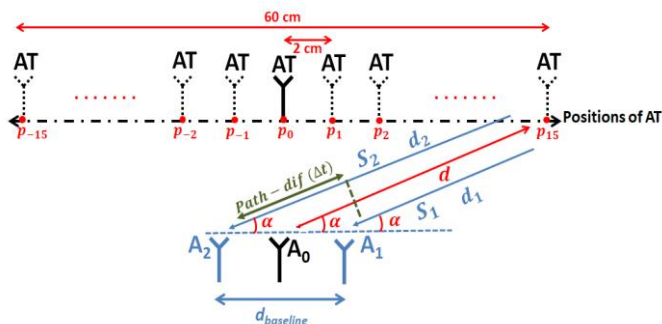

Figure 2. Method of the AT localization

To this end, we assume that S_i reach A_i with time-of-flight T_i ($i = 1, 2$). T_i is obtained by applying the ED method [23] where the ToA of the received signal S_i is estimated by looking for the block of width T_b (shown in Fig.3) carrying the maximum energy. Therefore, the radial distance d_i between A_i and AT is given by $d_i = c T_i / 2$, where c is the speed of light.

Finally, the radial distance d between A_0 and AT is given by

$$d = \frac{d_1 + d_2}{2} \quad (1)$$

On the other hand, the Path difference (*Path - dif*) between the two parallel independent incoming signals at an angle α with the baseline, as shown in Fig. 2, is given by

$$Path - dif = d_{baseline} \cdot \cos \alpha = c \cdot \Delta t \quad (2)$$

We assume that d_1 and d_2 are large enough compared to $d_{baseline}$ [16] in order to insure the parallelism conditions between the incoming signals. Therefore, the azimuth angle α is given by

$$\alpha = \cos^{-1} \left(\frac{c \cdot \Delta t}{d_{baseline}} \right) \quad (3)$$

where Δt is the estimated time difference between the two received signals S_1 and S_2 .

Fig.3 shows the transmitted signal S and the two received signals S_1 and S_2 . As we can see, S_1 and S_2 are similarly distorted by the circuit components and the antennas.

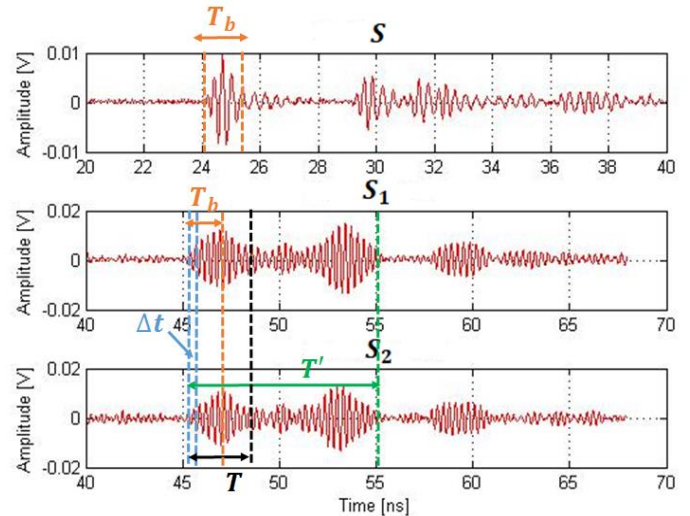

Figure 3. Transmitted and received signals

S_1 and S_2 can be described by a cosine carrier modulated by a Gaussian pulse [17] as:

$$S_1(t) = A \cos(2\pi f_0 t) e^{-\left(\frac{t}{T\tau}\right)^2} \quad (4)$$

$$S_2(t) = A \cos(2\pi f_0(t - \Delta t)) e^{-\left(\frac{t-\Delta t}{T'}\right)^2} \quad (5)$$

where A is the signals amplitude, f_0 is the signals carrier frequency, Δt is the time difference and T' is the distorted pulse duration.

The cross-correlation function $C_{S_1 S_2}(\Delta t)$ applied to $S_1(t)$ and $S_2(t)$ is given by

$$C_{S_1 S_2}(\Delta t) = \frac{A^2}{T} \int_0^T \cos(2\pi f_0 t) \cos(2\pi f_0(t - \Delta t)) \cdot e^{-\left(\frac{t}{T'}\right)^2} e^{-\left(\frac{t-\Delta t}{T'}\right)^2} dt \quad (6)$$

The duration analysis window T is equal to the initial pulse width, here 2 ns. With an azimuth angle close to 90° , the $Path - dif$ is too small to measure.

With $T, \Delta t \ll T'$, the cross-correlation function $C_{S_1 S_2}(\Delta t)$ can be expressed as follows [18]:

$$C_{S_1 S_2}(\Delta t) \approx \frac{A^2}{2} \cos(2\pi f_0 \Delta t) \quad (7)$$

which is considered as a PC method directly related to the azimuth angle α through Δt .

III. Simulated and Experimental Results

This section describes the setup. The two receiving antennas A_1 and A_2 are fixed and distant by $d_{baseline} = 29$ cm. This value of $d_{baseline}$ is adopted to guarantee an appropriate trade-off between the available equipment, the size of the receiving antennas A_1 and A_2 and the minimum value that maintains the parallelism conditions between the received signals [16]. The AT can take 31 different positions p_i (p_{-15}, \dots, p_{15}) in the range $[-30 \text{ cm}; 30 \text{ cm}]$, by shifting it 2 cm on each side of its initial position p_0 as shown in Fig. 2, such that A_5 and A_6 remains orthogonal to the AT displacement plane. At p_0 , the AT is equidistant from the two receiving antennas and located at a distance of 1.5 m from the baseline axis. This configuration is also used for the Matlab simulation bench which employs CM3 channel model (office LoS) of IEEE 802.15.4a with an SNR of 15 dB. A sampling frequency of 40 GHz is used in the oscilloscope.

Fig. 4, Fig. 5 and Fig. 6 show the actual distances d_1 , d_2 and d with that simulated and measured by the ED method, respectively. The x-axis corresponds to the different positions of the AT. As we can see, the simulated and measured results using the ED method are not the same. The simulated distances follow approximately the same behavior of the actual distance but with some errors. On the other hand, the behavior of the measured distances seems more random but overlaps with the actual distances in some positions. Therefore, the distance estimation can be further improved to

make the method more robust, perhaps using a detection threshold.

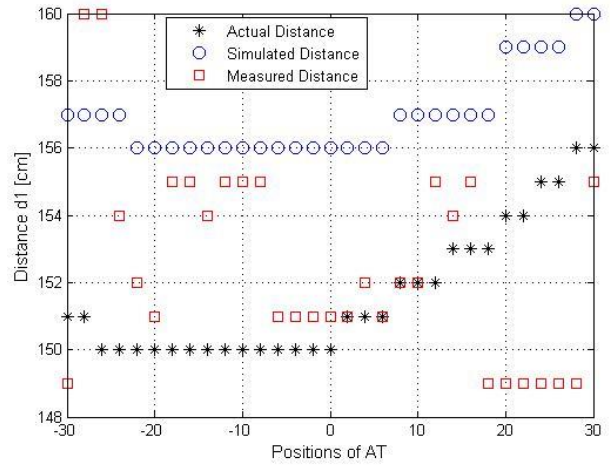

Figure 4. Distance d_1

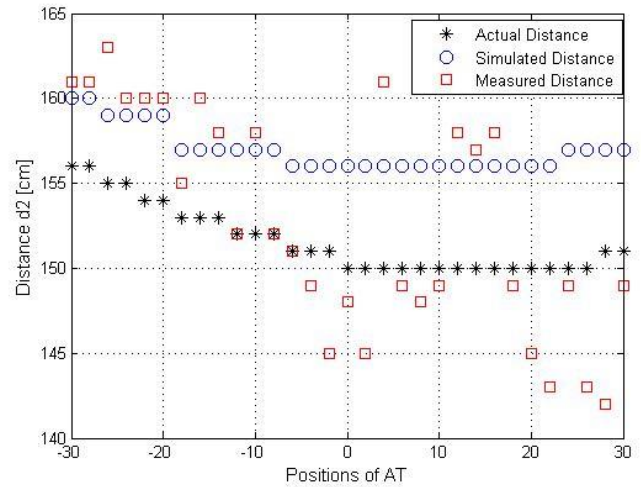

Figure 5. Distance d_2

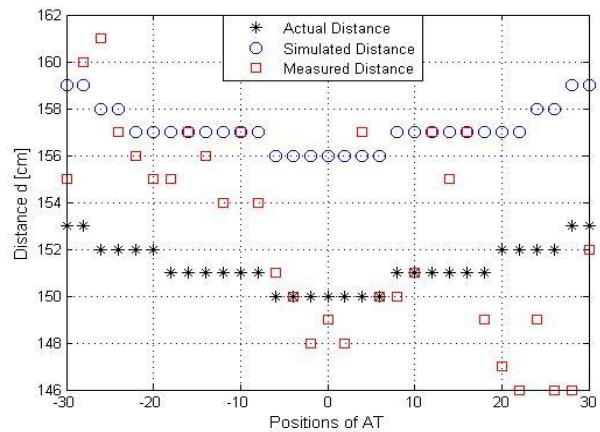

Figure 6. Radial distance d

Fig. 7 shows the actual path difference with that simulated and measured by the ED and PC methods for the 31 different positions. As we can see, the ED and PC methods are each giving roughly the same results in simulations and measurements. The minimum path difference that the ED method can detect is 30 cm. This value is directly related to the adopted block width T_b which determines the minimum energy to be detected. In this setup, T_b is fixed to 1 ns. In contrast, the PC method can detect a minimum path difference of 0.75 cm. However, the maximum actual path difference $|d_2 - d_1|$ which corresponds to the positions p_{-15} and p_{15} , is equal to 5.7 cm for this particular system. Therefore, the ED method cannot identify the exact positions of the AT, while the PC method can detect all of its different positions.

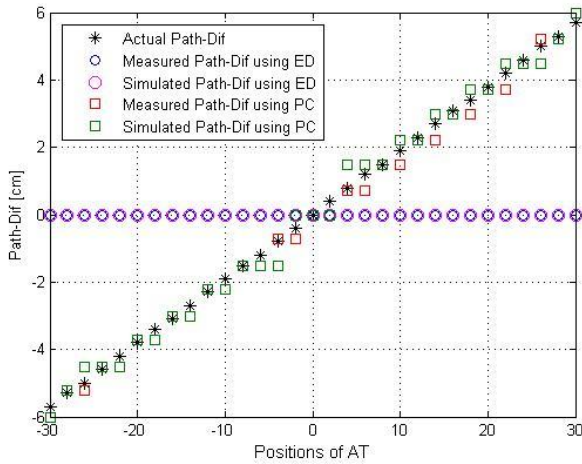

Figure 7. Path difference

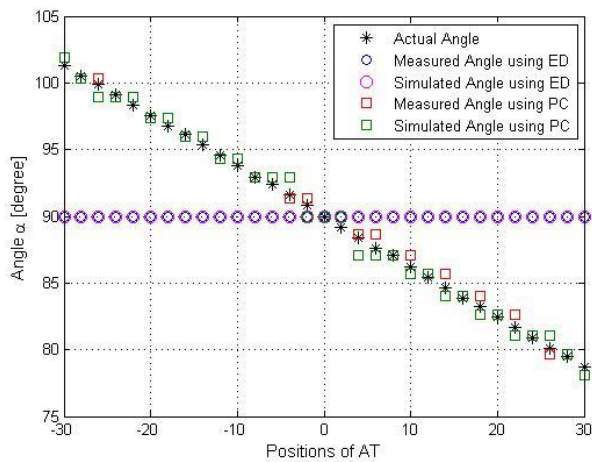

Figure 8. Azimuth angle α

The same comparison is carried out for the Azimuth angle α in Fig. 8, since it is derived directly from the $Path - dif$ according to (2). A maximum angle error of 11.3° is observed for the ED method. This error decreases to 1.4° using the PC method (error of 3.5 cm in the AT position). Over the 31

positions of the AT, the Root Mean Square Error (RMSE) decreases from 7° with the ED method to 0.6° with the PC method.

Table 1 summarizes the RMSE of distances and azimuth angle estimation for our ILS. Compared to previous works, our proposed method was able to achieve a very low RMSE in the angle estimation and thus improves the accuracy of the system. On the other hand, even though the RMSE of the distance estimation is quite good but there is room for further improvement in accuracy and resolution.

TABLE I. RMSE OF DISTANCES AND ANGLE ESTIMATION

	α	d_1	d_2	d
Simulated	0.6°	4 cm	5 cm	4 cm
Measured	0.6°	5 cm	5 cm	5 cm

iv. Conclusion

In this work, we have shown that the Azimuth angle resolution and accuracy can be improved from 7° to 0.6° by applying the PC method on the two received signals. As future work, we propose to estimate the distance d with a better accuracy and resolution by adapting the duplex method to UWB signals.

References

- [1] D. Mohapatra and S. B. Suma, "Survey of Location Based Wireless Services," IEEE International Conference on Personal Wireless Communications (ICPWC), pp. 358–362, January 2005.
- [2] F. Seco, A. R. Jimenez, C. Prieto, J. Roa and K. Koutsou, "A Survey of Mathematical Methods for Indoor Localization," IEEE International Symposium on Intelligent Signal Processing (WISP), pp. 9–14, August 2009.
- [3] Y. Gu, A. Lo and I. Niemegeers, "A Survey of Indoor Positioning Systems for Wireless Personal Networks," IEEE Communications Surveys and Tutorials, vol. 11, no. 1, pp. 13–32, 2009.
- [4] A. Runge, M. Baunach and R. Kolla, "Precise Self-Calibration of Ultrasound Based Indoor Localization Systems," International Conference on Indoor Positioning and Indoor Navigation (IPIN), September 2011.
- [5] P. Bahl and V. N. Padmanabhan, "User Location and Tracking in an In-Building Radio Network," Microsoft Research Technical Report: MSR-TR-99-12, February 1999.
- [6] S. Kawakubo, A. Chansavang, S. Tanaka, T. Iwasaki, K. Sasaki, T. Hirota, H. Hosaka and H. Ando, "Wireless Network System for Indoor Human Positioning," International Symposium on Wireless Pervasive Computing, pp. 1-6, 2006.
- [7] L. M. Ni and Y. Liu, "LANDMARC: Indoor Location Sensing Using Active RFID," IEEE International Conference on Pervasive Computing and Communications, pp. 407-416, 2003.
- [8] M. G. Di Benedetto and B. R. Vojcic, "Ultra Wide Band Wireless Communications: a Tutorial," Journal of Communications and Networks, vol. 5, no. 4, pp. 290–302, 2003.
- [9] I. Guvenc and Z. Sahinoglu, "Threshold-based TOA Estimation for Impulse Radio UWB Systems," IEEE International Conference on Ultra-Wideband, September 2005.

- [10] I. Guvenç and Z. Sahinoglu, "Multiscale Energy Products for ToA Estimation in IR-UWB Systems," IEEE Global Conference on Communiations (GLOBECOM), 2005.
- [11] Z. Tingting, Z. Qinyu, Z. Naitong and X. Hongguang, "Performance Analysis of an Indoor UWB System Based on Energy Detection," Annual Communications Networks and Services Research Conference, 2009.
- [12] L. Stoica, A. Rabbachin and I. Oppermann, "A Low-Complexity Noncoherent IR-UWB Transceiver Architecture With ToA Estimation", IEEE Transactions on Microwave Theory and Techniques, vol. 54, no. 4, April 2006.
- [13] A. Benlarbi-Delai, J.C. Cousin, R. Ringot, A. Mamouni and Y. Leroy: ' Microwave short baseline interferometers for localization systems', IEEE Trans. Instr. & Meas., vol. 50, no.1, pp: 32-39, Article ID: 10.1109/19.903875, 2001.
- [14] T. Jalloul and W. Ajib, "DME/DME Navigation Using a Single Low Cost SDR and Sequential Operation," Digital Avionics Systems Conference, October 2014.
- [15] N. Awarkeh, J. C. Cousin, M. Muller and N. Samama, "Improvement of The Angle Measurement Accuracy for Indoor UWB Localization," European Microwave Week (EUMW), September 2018.
- [16] R. Kumar, B. Huyart, J.C. Cousin and K. Mabrouk, "2D Measurement using Interferometry and FMCW Multistatic Radar System for Indoor Localization," European Radar Conference, pp. 17-20, October 2013.
- [17] S. de Rivaz, B. Denis, J. Keignart, M. Pezzin, N. Daniele and D. Morche, "Performances Analysis of an UWB Receiver using Complex Processing," IEEE Conference on Ultra WideBand Systems and Technologies, pp. 229-233, November 2003.
- [18] B. Vollmer, "Interférométrie," Astronomie - Astrophysique, University of Strasbourg, September 2003.



Muriel Muller holds a PhD from the University of Paris 6 in physical and electronic sciences in 2002. His thesis was carried out in the OPTO+ Alcatel laboratory and focused on the bipolar phototransistor InP/InGaAs as an optical/electrical mixer for conversion to the millimetre band in the fiber radio access network. Since then, she has been an associate professor in the Electronics and Physics (EPH) department of the "Institut Polytechnique de Paris" France, where she teaches microwaves and analog electronics. Her research interests include UWB systems for communication, localisation and health application, microwave circuit design, and multi-standard GNSS receiver design.



Nel Samama received the diploma of engineer in Mechanics and Electricity from the "Ecole Spéciale des Travaux Publics", Paris, in 1985, the M.Sc. degree in Computer Science from the University of Birmingham, UK, in 1985 and the Ph.D. degree in Electrical Engineering and Computer Science from the University of Paris in 1989. From 1989 to 1997, he worked for the Thales Group where he designed behavioral modeling for microwave and electronic components stressed by high power microwave radiation. In 1997, he joined the "Institut Polytechnique de Paris", France, as a professor. Since 1997, he has been working within the GNSS field. His current interests are to find indoor positioning techniques to "augment" the current GNSS outdoor systems.

About Authors:



Nour Awarkeh received the Engineering degree in Telecommunications and Computer Science from the Lebanese University, Beyrouth, Lebanon, and the M.Sc. degree in Digital Communication Systems from Telecom Paris, France, both in 2016. She is currently pursuing the Ph.D. degree with the Department of Communications and Electronics (COMELEC) at Telecom Paris. Her current research interests include indoor localization and UWB systems.



Jean-Christophe Cousin was born in Boulogne sur mer, France, in 1973. He received the M.S. degrees in Electronic from the University of Lille 1, France, in 1997 and the Ph.D. degree in Electronic from University of Lille 1, France, in 2001. From 2001 to 2002, he was a Research Assistant with the IEMN Laboratory at Lille. Since 2002, he has been an Associate Professor with the COMELEC Department, Telecom Paris, Paris. His research interests include indoor localization, channel sounding for LTE-A standard and Local oscillator for LTE-A standard.