

A Study and Comparison of Low Power CMOS Voltage Reference

Sandeep K. Arya, Manoj Kumar, Ashok Kumar

Department of Electronics & Communication Engineering

Guru Jambheshwar University of Science & Technology, Hisar, India (125001)

ashokkdhanian@gmail.com

Abstract-This paper presents a study and comparison between CMOS low power voltage reference in terms of voltage independent over the temperature .The reference voltage circuits are designed & simulated in SPICE with 0.35- μm technology with supply voltage (VDD) of 2.5 V & 1.8 V respectively. The simulated results show that the circuits generate an average reference voltage of 246.66 mV & 817.0 mV respectively and there is only small variation of ± 2 mV & ± 0.2 mV from the temperature range of -40 °C to 120 °C. The circuits consume approximately 10.49 μW & 69.8 μW of power dissipation from a supply voltage of 2.5 V & 1.8- V respectively.

I. INTRODUCTION

Low voltage and low power are two important design criteria in both the analog and digital systems. It is expected that the whole system will be able to operate down to a single 1 V supply in the near future [1], [2]. A voltage reference, as one of the core functional blocks in both analog and digital systems should be able to operate from a single 1 V supply for both systems. The voltage reference circuit is an essential element in the design of biasing schemes for analog or mixed-signal circuits, such as high precise analog to digital converters, digital to analog converters in DRAM's, flash memories, and analog devices etc. The main purpose of the voltage reference is to provide a voltage or current that is insensitive to supply voltage, temperature and process variations. Most of common voltage reference is the band gap reference (BGR) voltage based on bipolar devices [3]. DC values can produce undesirable effects such as bit errors in analog-to digital converters, non-linearity in RF mixers and low-noise amplifiers (LNA) [4]. Circuit design techniques have been developed to provide nearly zero or small DC variations with respect to each of three error generating parameters: temperature, process and supply. By using MOS devices in weak inversion, the constant bias current can be reduced to a few hundred nano-amperes, thus achieving very low quiescent power dissipation [5].

A study is given by the Allam and Filanovsky regarding about the MOSFET temperature behavior, the gate–source voltage of a MOSFET after biasing with a fixed drain current decreases with temperature [6]. Due to this condition a gate–source voltage can be used to design a voltage reference independent of temperature.

Here, in this paper the work reported by the G. Giustolisi, G. Palumbo et al. [7] & Shihabudheen T, V. Suresh Babu et al. [8] is extended.

II. CIRCUIT DESCRIPTION

A. The Voltage Reference with current bias:

Fig. 1 shows the voltage reference [7] circuit-I topology. It consists of two main sub-circuits. The first such circuit is composed of four MOSFET transistors M_{N1} , M_{N2} , M_{P3} , M_{P4} , bias current (I_B), capacitor C_1 and the resistor R_1 . The second such circuit is composed of transistors M_{P5} to M_{P8} & M_{N9} to M_{N11} , capacitor C_2 and three resistors R_2 , R_3 , R_4 respectively.

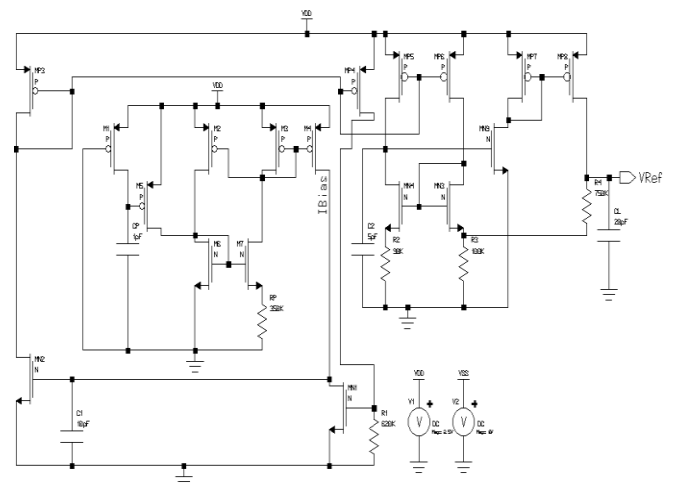

Fig. 1 Schematic of a Voltage Reference with Current Bias

The PMOS transistors M_{P10} , M_{P11} and M_{P12} are operating in the strong inversion saturation mode. The transistors aspect ratio of M_{P10} , M_{P11} and M_{P12} are same and both the resistors R_1 and R_2 are equal. Gate of transistors M_{P10} , M_{P11} and M_{P12} are connected to a common node forming a current mirror which produce the current I_1 , I_2 and I_3 of equal value. Also the aspect ratio of transistors M_{P1} , M_{P2} , M_{P3} , M_{P4} are same. The output reference voltage is generating through the load resistance R_L .

Due to the operation of the MOSFETs M_{N13} and M_{N14} in the sub threshold region, currents through the resistors R_1 and R_2 decrease as the temperature increases. Transistors M_{P1} to M_{P4} and M_{N5} to M_{N6} make the op-amp. The op-amp acts as an error amplifier producing a proportional to absolute temperature (PTAT) current through the resistor R_3 . The current flowing through transistors M_{P10} , M_{P11} is sum of two currents i.e. one is proportional to V_{GS} and other is proportional to thermal voltage V_T . So, such current generated is temperature independent current, which will flow through the transistor M_{P12} due to current mirroring. Hence output reference voltage across the load resistor R_L is independent of supply voltage (V_{DD}) and temperature variation.

The reference voltage thus produced is given by the equation

$$V_{Ref} = \frac{R_L}{R_2} \left(V_{GS1} + \frac{R_2}{R_3} \Delta V_{GS} \right) \quad (9)$$

III. RESULTS AND DISCUSSION

The low power CMOS voltage reference with bias current circuit and voltage reference with error amplifier have been simulated in SPICE with 0.35- μm technology with supply voltage (V_{DD}) of 2.5 V and 1.8 V respectively. Table 1. shows the comparison of result of process, minimum power supply voltage, reference voltage and power dissipation of these voltage reference circuits. Table 1. shows that power dissipation of low voltage CMOS voltage reference is less as compared to other circuit. Fig. 4 to fig. 9 shows the reference voltage vs. temperature, supply voltage & time relationship for voltage reference with current bias and voltage reference with error amplifier. Fig. 4 and fig. 7 show that there is small variation of reference voltage over the temperature range of -40 °C to 120 °C. Here fig. 6 shows that reference voltage is constant with time for the voltage reference with current bias and fig. 9 shows that reference voltage is approximately constant with time for the voltage reference with error amplifier.

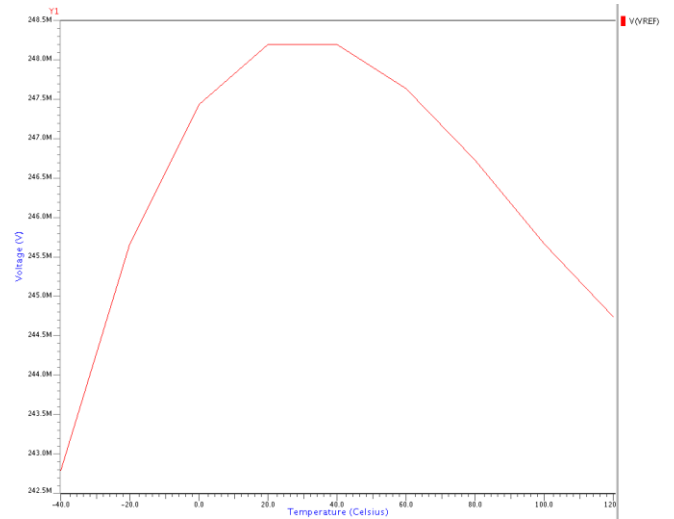

Fig. 4 Reference Voltage vs. Temperature of Voltage Reference with Current Bias

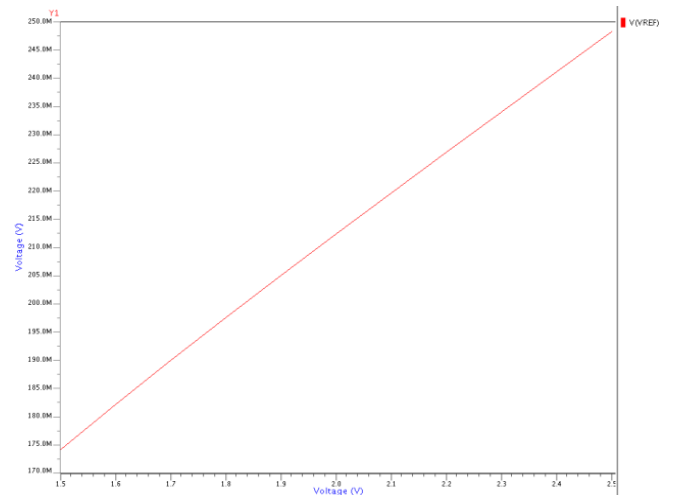

Fig. 5 Reference Voltage vs. Supply Voltage of Voltage Reference with Current Bias

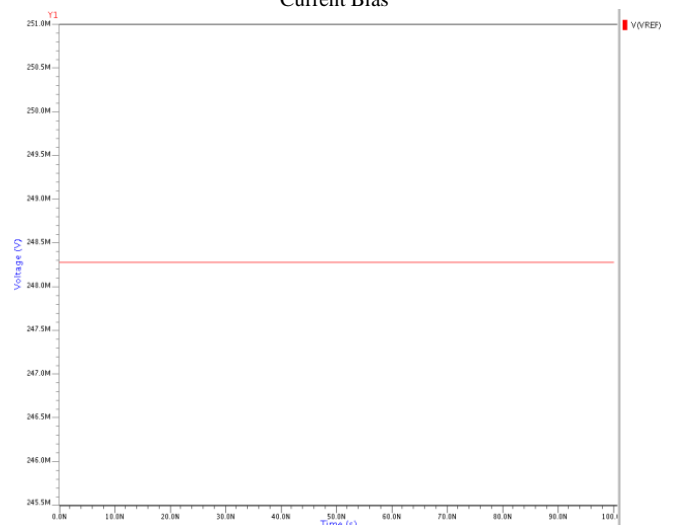

Fig. 6 Reference Voltage vs. Time of Voltage Reference with Current Bias

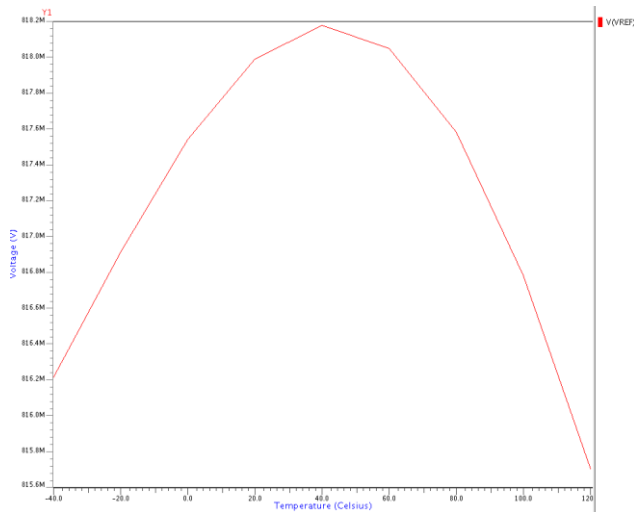

Fig. 7 Reference Voltage vs. Temperature of Voltage Reference with Error Amplifier

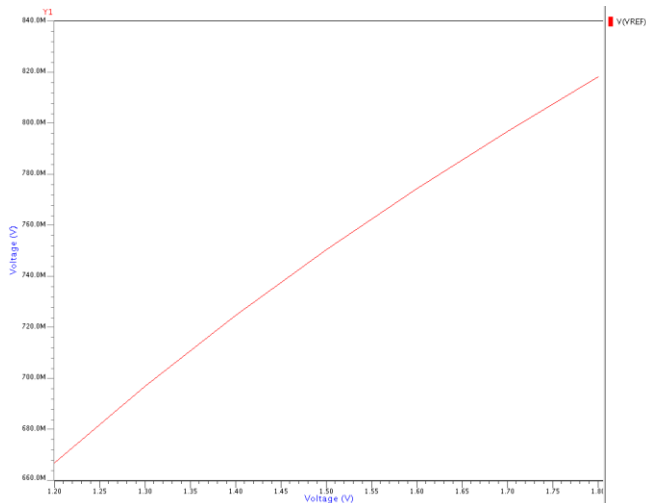

Fig. 8 Reference Voltage vs. Supply Voltage of Voltage Reference with Error Amplifier

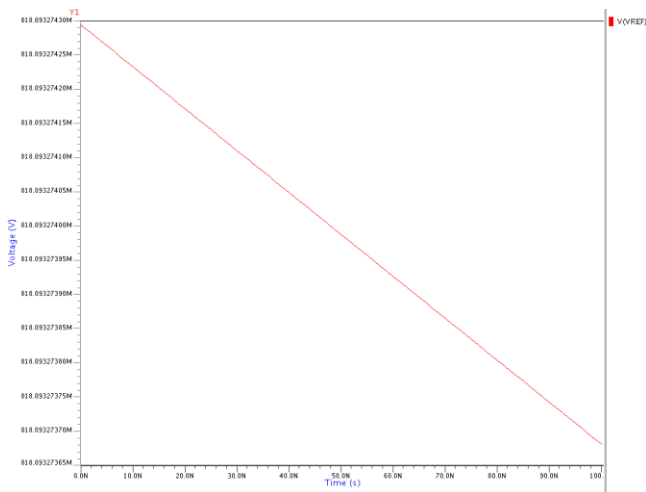

Fig. 9 Reference Voltage vs. Time of Voltage Reference with Error Amplifier

TABLE 1. COMPARISON BETWEEN VOLTAGE REFERENCES

	Minimum Supply Voltage (V)	Reference Voltage (mV)	Power Dissipation (μ W)	Process Technology (μ m)
[7]	1.5	246.66	10.49	0.35
[8]	1.2	817.37	69.8	0.35

IV. CONCLUSION

The low power CMOS voltage reference with bias current circuit and voltage reference with error amplifier have been simulated in SPICE with 0.35- μ m technology with supply voltage (VDD) of 2.5 V and 1.8 V respectively. The simulated results show that the circuits generate a reference voltage of 246.66 mV & 816.20 mV respectively and there is only small variation of ± 0.1 mV & ± 0.2 mV from the temperature range of -40 $^{\circ}$ C to 120 $^{\circ}$ C. The circuits consume approximately 10.49 μ W & 69.8 μ W of power dissipation from a supply voltage of 2.5 V & 1.8 V respectively. The total variation in the reference voltage is 2.27% over the temperature range of -40 to 100 $^{\circ}$ C for the voltage reference with current bias and 0.25% over the temperature range of -40 to 100 $^{\circ}$ C for the voltage reference with error amplifier.

REFERENCES

- [1] Pierazzi, Andrea, et al., "Band-gap reference for near 1-V operation in standard CMOS technology", IEEE 2001 custom integrated circuits conference, pp. 463-466, 2001.
- [2] K.N. Leung and P.K.T. Mok, "A sub 1V 15ppm/ $^{\circ}$ C CMOS bandgap voltage reference without requiring low threshold voltage device," IEEE journal of solid-state circuits, vol.37, pp.526-530, April 2002.
- [3] R. J. Widlar, "New developments in IC voltage regulators," IEEE J.Solid-State Circuits, vol. SC-6, pp. 2-7, Feb. 1971.
- [4] Baker, Jacob R., Li, Harry W. et al., CMOS circuit design, layout, and simulation, New York, IEEE Press, 1998.
- [5] K. Manetakis, "CMOS micro-power output stage for integrated voltage references," Electronics Letters, 22nd July, 2004, Vol.40, No.15.
- [6] M. Filanovsky and A. Allam, "Mutual compensation of mobility and threshold voltage temperature effects with applications in CMOS circuits," IEEE Trans. Circuits Syst. I, vol. 48, pp. 876-884, July 2001.
- [7] G. Giustolisi, G. Palumbo et al., "A low-voltage low-power voltage reference based on subthreshold MOSFETs," IEEE Journal of Solid-State Circuits, Vol. 38, No. 1, January 2003.
- [8] Shihabudheen T, V. Suresh Babu et al., "A low power sub 1V 3.5ppm/ $^{\circ}$ C voltage reference featuring subthreshold MOSFET's," IEEE ICECS 2008, pp. 438-441, Nov. 2008.