

# Advances in Fiber-Wireless Network Architecture Approach to the Next-Generation Communication Systems

[Tatiana Bakhvalova, Mikhail Belkin, Dmitriy Fofanov]

**Abstract**—The principles, features, and ways to advance in designing an information and communication 5G-class network using fiber-wireless architecture are reviewed. As an example, the arrangements for implementing such a network in a metropolitan area are proposed and described.

**Keywords**—fifth-generation communication network, backhaul fiber-optics architecture, fronthaul fiber-wireless architecture; base station.

## I. Introduction

As known, the basic requirements in the field of telecommunications for the worldwide community in the 21st century are higher data rate, reduced latency and continuous connection to the end user. The first two requirements are met mainly through the development of fiber-optic technologies, and at present, the throughput of digital fiber-optic communication systems (FOCS) has exceeded 1 Tbit/s. The latter need can be effectively solved by the development of wireless technologies. However, fundamental problem of the existing wireless communication systems lies in insufficient bandwidth. Thus, fiber-optic and wireless access networks are at the center of the scientific community's attention as the most relevant and significant technologies over the past two decades [1].

The above-mentioned bandwidth makes FOCS a leading technology not only for transport networks, but also for next-generation access networks. Unfortunately, an important drawback for the implementation of the access networks lies in the complexity and high cost associated with the need to lay the optical cables up to user terminals. Although traditional wireless access networks provide a flexible communication with a relatively simple infrastructure, they cannot meet a growing need to increase the capacity of communication systems. The most promising way to enhance data rate, which is actively discussed in recent publications, is to raise the operating frequency band and to apply multi-position digital modulation format of the carrier. Thus, the integration of these technologies into hybrid fiber-wireless (FiWi) access networks, which is a distinctive feature of the 5th generation (5G) communications systems, is an obvious solution in the context of both capacity and high mobility [2].

In general, the key advantages of the FiWi architecture for the communication networks are the following [2-6]:

Moscow, Russian Federation

- higher noise immunity, since data streams are mainly delivered through fiber-optic links;

- small attenuation of signal power in fiber-based transmission path due to the fact that the losses in the fiber optic cable are four orders of magnitude smaller than in the coaxial one;

- relative simplicity of implementation and deployment at site by applying a remote base station concept that can service a significant number of user wireless terminals;

- a lower cost of construction and operation that simplifies the structure and reduces the power consumption of base stations due to using in the access networks the principle of transmission of digital streams on the subcarriers of the radio-frequency (RF) band;

- great future-proof design due to the fact that the ultra-wideband of fiber-optic communication links guarantees minimal additional capital investments to upgrade the network throughput.

Based on the benefits noted above, this paper reviews the principles, features, and ways to advance design of fifth-generation network using FiWi architecture. To validate the concept, we demonstrate and describe an example for implementing such a network in a metropolitan area.

## II. The Design Features of the Fifth Generation Information and Communication Networks

In the last decade, the problem of developing and optimizing the architecture of the fifth-generation communication networks and developing equipment for their implementation has received the closest attention of the global telecom community [7]. It is predicted that the implementation of these next-generation networks (usually named 5G NR) will provide unprecedented amounts of data and services for mobile and fixed users, which can be called both an evolution and a revolution in mobile cell technologies [2]. They are or architectural in nature—for example, moving some of the decision making to the devices themselves (device-centric architectures and smart devices), or most network hardware-oriented. Besides, continuously increasing requirements for broadband services and capacity of communication links by enhancing the data transfer rate in all sections of the cellular network led to the shift of the operating frequency to

---

Tatiana Bakhvalova, Mikhail Belkin, Dmitriy Fofanov  
MIREA - Russian Technological University, Scientific and Technological Center "Integrated Microwave Photonics"

millimeter-wave band, with a total cell capacity of several gigabits per second.

Table 1 lists three key advanced engineering tasks facing 5G network designers [2, 5].

The first one is ultra-densification of service areas and users. As the result, an advanced principle to design a FiWi architecture-based network using a set of interconnected cells of different footprints is proposed: from a standard macrocell with a service radius of several kilometers to a femtocell with a service radius of no more than 50 m [2].

The second one involves the widespread use of the millimeter-waves (mmWave) radio spectrum extending from Ka- to W-band [7, 8]. Following it, microwave photonics-based network equipment design comes to the forefront as a promising solution.

Finally, the third one is an "explosion" of mobile data traffic. To implement it, it is necessary to increase the data transmission speed in the transport network to tens of Tbit/s, and in the access network - up to 10 or more Gbit/s.

The data, obtained from the analysis of a large number of publications, on the quantitative parametric comparison for wireless networks of the fourth and fifth generations, are presented in Table II.

The solution of the problems considered in Tables I and II required a significant complication of the standard cellular network structure. In the result, advanced skeleton diagram of 5G network using a common central office (CO), fiber backhauls and Fi-Wi fronthauls is shown in Figure 1.

To satisfy the requirements for a significant increase in traffic specified in Table II, a promising frequency plan specifically designed for networks of the 5th generation of wireless networks in the millimeter-wave range is currently proposed (Figure 2).

TABLE I. THE KEY ADVANCED ENGINEERING TASKS FACING THE FUTURE 5G NETWORK

No	Task	Advanced result
1	Ultra densification of service areas	FiWi architecture with nanocells
2	Wireless communication in millimeter-wave band	Implementing microwave-photonics for the network equipment design
3	Mobile data traffic explosion	1,000-fold factor over present-day systems

TABLE II. A COMPARISON OF THE KEY PARAMETERS ACHIEVED IN THE FOURTH GENERATION WIRELESS NETWORKS WITH SIMILAR PARAMETERS TO BE ACHIEVED IN THE FIFTH GENERATION NETWORKS

Parameter	4G	5G
Connections density (per km <sup>2</sup> )	Less 200K	Up to 1M
End-to-end latency (ms)	> 50	< 1
Users mobility (km/h)	Up to 80	Up to 500
Peak data rate in cell (Gbit/s)	< 1	> 20

Traffic volume density (Tbit/s/km <sup>2</sup> )	< 1	Up to 10s
User experienced data rate (Gbit/s)	< 0.1	Up to 1

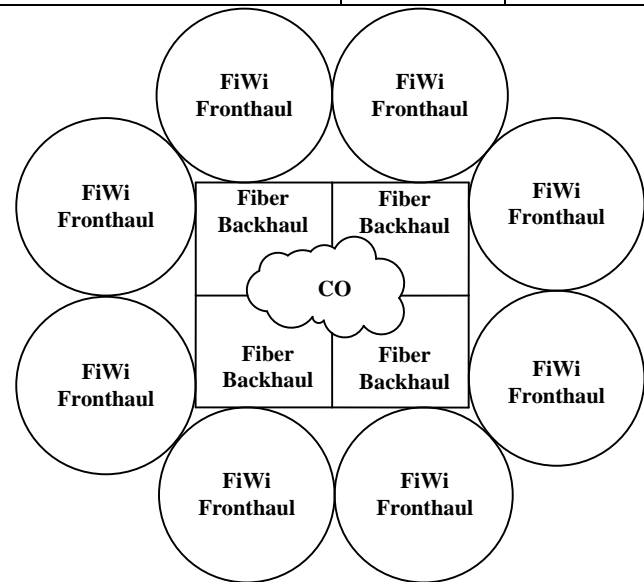

Figure 1. Advanced skeleton diagram of 5G cellular communication network

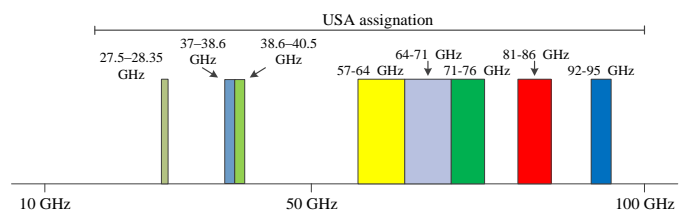

Figure 2. 5G's millimeter-wave spectrum allocation of USA assignment

Thus, according to the generally accepted opinion, the ambitious goals for the development of 5th generation wireless networks can be achieved by solving two advanced global tasks: architectural, connected with the introduction of the fiber-wireless architecture an access network, and the technological, associated with the introduction of microwave photonics approach to the design of its equipment. The latter is especially important for interface network units, both between the fiber-optic backhaul network and fronthaul networks, whose task is to transfer of high-speed data stream to millimeter-wave carriers, and between wired and wireless sections of the access network, in which the signals of the optical and millimeter-wave bands, should be cost-efficiently converted.

### III. General Principles for Design Fronthaul Networks of Fiber-Wireless Architecture

As well known, the modern local telecom networks use combined architecture. Widespread example of this approach is fiber-coaxial networks that utilized in up-to-date interactive cable television. Similar approach may be applied to the fifth-generation cellular communication networks with fronthaul sections based on fiber-wireless architecture. Figure 3

demonstrates a typical FiWi architecture, which consists of central office (CO), a number of remote or base stations (BS) and wireless user terminals (UT). Central office is interactively connected with BSs through fiber-optic cables, and each BS is interactively connected with UTs through wireless links.

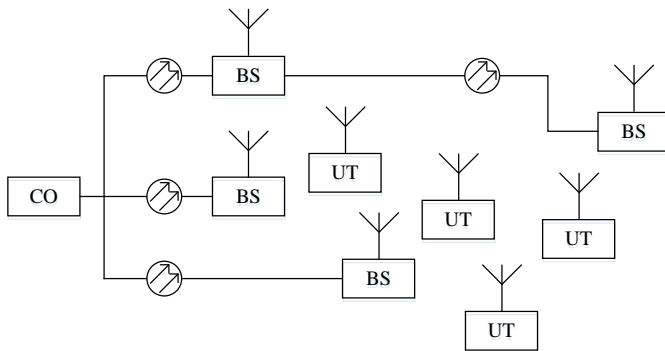

Figure 3. A typical Fi-Wi architecture

At the central office, the optical transmitter is modulated on sub-carriers of the millimeter band by digital information signals at speeds of 1...10 Gbit/s. Then, fiber-optics links connect the CO and base stations. Each BS carries out optical-electrical conversion and wireless transmission within the area with a radius of up to 50-100 m. The RF signals are received and demodulated by user terminals. The transfer of signals from the user occurs in the reverse sequence.

Due to the distributed structure and operation in the millimeter-wave band the approach has the following key advantages :

- Higher channel capacity;
- Reduced interference between base stations;
- Better size and weight characteristics of receiving and transmitting equipment, and antennas.

As a result, this architecture provides for better cost-effectiveness, reduced deployment time, and continuous accessibility of the users.

We perform a general analysis for communication fronthaul network of the fiber-wireless architecture, the structural diagram of which is shown in Figure 3. In accordance with the terminology established for communication systems, we take the direction of signal transmission from the CO to the UT (otherwise the outgoing direction) as the downlink channel, and the direction from the UT to the CO (otherwise the incoming direction) as the uplink channel. The signals between the CO and BS are transmitted in both directions along the fiber-optics links in the spectral bands corresponding to the third (1.5 ... 1.6 μm) transparency window of the quartz fiber.

In general, the fronthaul network of fiber-wireless architecture represents the further development of cellular communication networks. The peculiarity of construction in comparison with the traditional system of cellular communication is in a much smaller size of cells. So, at the present time, two options are developed based on so-called

picocells with radii of up to 200-300 m and in recent years on femtocells with radii from tens of centimeters to 20-50 m (for example, inside the building). Due to the relatively small number of users it is critical to reduce cost of BS equipment, in fact, representing the interface between the optical and RF sections of the transmission system. The most promising solution to this problem is the ultimate simplification of the BS equipment, which could be done by shifting all the processing units (generation, modulation, demodulation, etc.) to the CO or BS of a higher level. In essence, a package of modulated microwave carriers with frequencies corresponding to the operating frequencies of the FiWi fronthaul is fed to the inputs of the optical transmitters of the CO (downlink channel) and the BS (uplink channel). Transmission of these carriers through fiber-optics links is most economically realized using the same multichannel analog FOCS. So, the decisive influence on their characteristics effects the scheme of transporting microwave analog signals through a fiber-optics cable between the CO and BS. The feasible variants are compared in Table III. For the possibility of quantitative analysis, we take the widely used bitrate for the modern networks of 1 Gbit/s (for example, the standard Gigabit Ethernet).

TABLE III. COMPARISON OF THE FEASIBLE OPTIONS FOR TRANSPORTING MICROWAVE ANALOG SIGNALS THROUGH A FIBER-OPTICS CABLE

Transmission Range	Option 1. In baseband	Option 2. In the band of intermediate RF signals	Option 3. In the band of RF sub-carriers
Type of FOCS	Digital	Analog	Analog
Upper modulation frequency (GHz)	1	10-15	60-80
Relative bandwidth (%)	100	40	30
Demands to Signal-to-Noise ratio	Low	High	High
Demands to the equipment linearity	Low	High	Middle
Complexity of CO layout (cost)	Low	Middle	High
Complexity of BS layout (cost)	High	Middle	Low

The following conclusions can be derived from the Table:

- To realize option 1 it is necessary to use digital FOCS. Whereas for the second and third options, analog FOCS is required with its inherent higher requirements for the signal-to-noise ratio and the linearity of the equipment.
- The value of the upper modulation frequency in the second and, especially, in the third options is significantly higher in comparison with the first one, which tightens the requirements for the electronic and optoelectronic components of the CO equipment and, as a result, its cost.
- The bandwidth of the transmission channel for the second and third options is substantially lower than in the first one, which simplifies the circuitry of the CO and BS

equipment’s amplifying and converting units and, as a result, improves their cost characteristics.

- The option with transmission in the RF sub-carrier band is realized with the least number of transformations on the BS, which minimizes its cost, and, consequently, the cost of the entire user access network.

Further optimization should be focused on multi-branched fiber-optic networks. It is important to design their optimal topology. Let’s compare the three most commonly used topology in the design based on a specific example. Suppose that it is necessary to distribute the data signals from the base station BS0 to four BSs of the lower level with their positional relationship shown in Figure 4(a). Variants of realization using radial, radial-nodal and radial-circular network topologies are shown in the Figure 4(b-d). As can be seen, the circuitry of variant (b) is the simplest, but it’s the least economical, since the maximal length of the optical path is required. Besides, it is not reliable enough, because the break of one of the links leads to termination of the traffic for the corresponding BS. The circuitry of variant (c) is less reliable, since the link failure between BS0 and BS2 entails the termination of the traffic of three BSs at once. However, this topology is the most economical, since the minimal length of fiber-optics links is guaranteed. The best reliability with moderate construction costs is the radial-circular topology of Figure 4(d).

It is predicted that the main areas for the application of the FiWi-architected networks will be interactive local communication and distribution systems, such as, future-generation cellular communication systems, personal

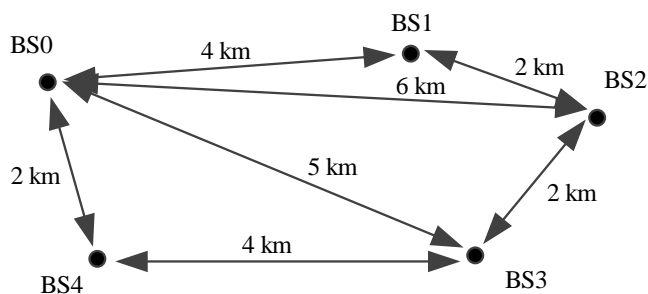

(a) The positional relationship of the BSs

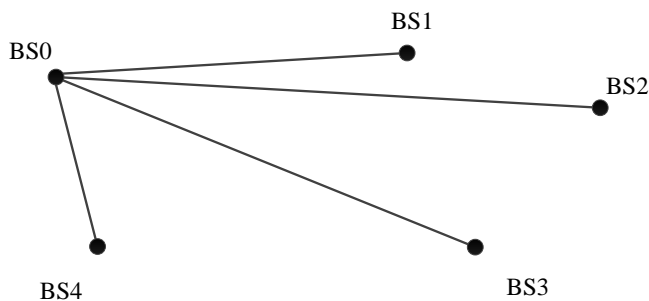

(b) Radial topology (overall length is 17 km)

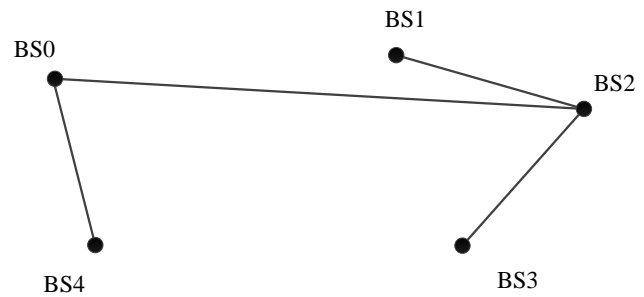

(c) Radial-nodal topology (overall length is 12 km)

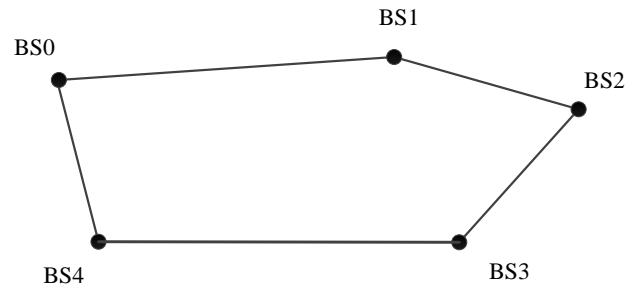

(d) Radial-circular topology (overall length is 14 km)

Figure 4. Variants for realization of fiber-optics links

communication systems, multi-gigabit ETHERNET distribution systems, IPTV-protocoled Internet television systems, etc.

## IV. Example of Building 5G Network for Metropolitan Area

Based on above addressed principles and design specialties, Figure 5 describes an example of 5G’s backhaul fiber-optics network for Moscow city. The city is located in the center of railway and highway transport nodes. The radial lines intersect with a set of the concentric rings, which unload traffic flows in the central part of the city, particularly the Moscow Automobile Ring Road (MKAD), the Third Transport Ring (TTK), the Garden Ring and the Boulevard Ring. There are several additional transportation systems that form circles around the city, such as the railway and the underground. This transport infrastructure leads to concentration of business and leisure activity along radial and ring roads, at their intersections, and in the downtown, and therefore we expect high concentration of mobile users in these areas. For this reason, it is economically



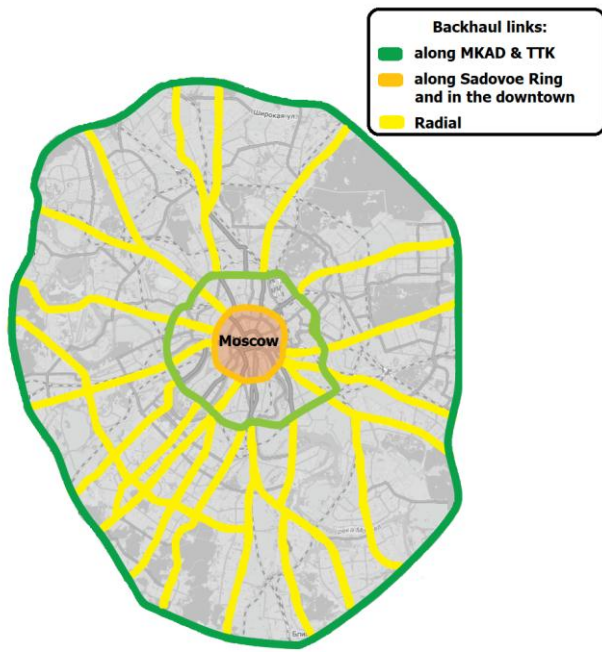

Figure 5. Backhaul network of Moscow metropolitan area

points of the optical fiber links. As can be seen from the Figure, the backhaul network well repeats the existing transport infrastructure.

The net of transport infrastructure split the city into segments and their contours resemble the administrative districts. In areas with high-rise buildings and high density of mobile users, issues of coverage and throughput are to be solved via pico- and femtocells with a limited service radius of 50 to 200 meters. Pico- and femtocells are connected to the macro BSs, exchanging signals with them via the FiWi fronthaul network. The structure of the fronthaul network for the Khamovniki district, located 5 km from the Moscow Kremlin, is shown in Figure 6. It is extremely important to maintain high and stable quality of experience for thousands of mobile users in this area. Exhaustive coverage is provided by the 14 pico- and 19 femtocells inside each of them, which BSs are connected to the macro BS via “star” topology and providing mobile and fixed wireless access along with it. Progressive deployment of proposed fronthaul networks around existing and new types of base station arrangement [9] is a promising and economically effective way of moving towards 5G.

feasible to start the deployment of the 5G network in such highly populated sites. The corresponding number of backhaul hubs (node stations) should be located at the intersection

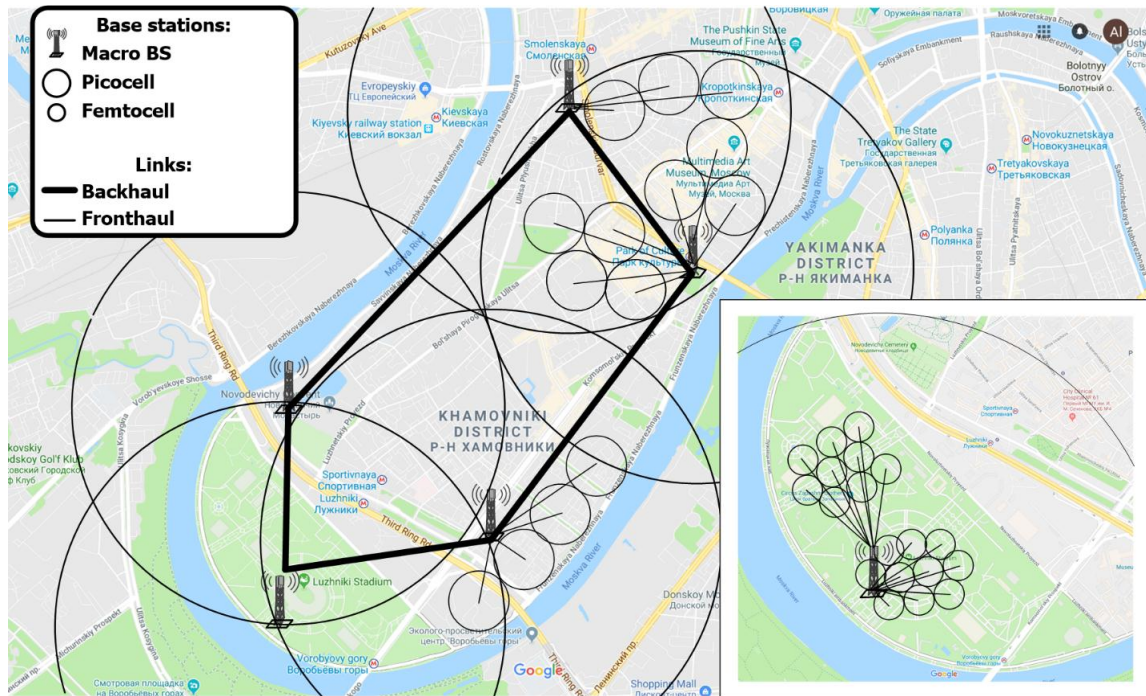

Figure 6. Fronthaul network of Khamovniki district

## v. Conclusion

The general principles of constructing the fifth-generation information and communication system containing a fiber-optic backhaul network and operating in the millimeter-wave

band fronthaul network of fiber-wireless architecture are considered. Based on the advantages of this approach, the principles and peculiarities for the construction of a 5G communication network was studied. As an example, an arrangements of the backhaul fiber-optics network and fiber-

wireless fronthaul network in Moscow metropolitan area were described.

### ***Acknowledgment***

This work was supported by the Russian Foundation for Basic Research, Grant No. 17-57-10002.

### ***References***

- [1] Frank Effenberger, "Future Broadband Access Networks," Proceedings of the IEEE, vol. 104, No. 11, pp. 2078-2081, Nov. 2016.
- [2] Jeffrey G. Andrews et al., "What Will 5G Be?" IEEE Journal on Selected Areas in Communications, vol. 32, no. 6; pp. 1065 – 1082, Jun. 2014.
- [3] S. Chen and J. Zhao, "The requirements, challenges and technologies for 5G of terrestrial mobile telecommunication," IEEE Commun. Mag., vol. 52, no. 5; May 2014. pp. 36–43.
- [4] J. Munn, "Our 5G Future: In the Fast Lane with Numerical Simulation," Microwaves & RF; Dec. 2016. pp. 48-50.
- [5] L. Frenzel, "Making 5G Happen," Microwaves & RF, Dec. 2017, 5 p.
- [6] Boccardi F., et al., "Five Disruptive Technology Directions for 5G," IEEE Communications Magazine, Vol.52, Feb 2014, pp. 74-80.
- [7] R. Waterhouse, D. Novak, "Realizing 5G," IEEE Microwave Magazine, 2015, vol. 16, no 8, pp. 84-92.
- [8] Alavi S. E., Soltanian M. R. K., et al., "Towards 5G: A photonic based millimeter wave signal generation for applying in 5G access fronthaul," Scientific Reports. No 6; 2016. 11 p.
- [9] M.E. Belkin, "The Building Principles of a Cost- and Power-Efficient Base Station for Emerging Fiber-Wireless Networks," International Conference on Microwaves, Communications, Antennas and Electronic Systems, COMCAS 2017, pp. 1-4. Tel Aviv, Israel, 13-15 Nov. 2017.