

RLG Dither Removal Using Wavelet Transforms

Bharath Regimanu, Kakarla Subba Rao, Kishore Chandra Das, Ch.Raja Kumari, P.Neeharika

Abstract— Ring Laser Gyroscopes (RLGs) are widely used in many airborne and navigation systems for accurate measurement of the true rotation of the body movement. But the RLG's suffer a serious problem at low frequencies known as Lock-in frequency. To avoid lock-in problem, the RLG is vibrated mechanically to a high frequency which is known as Dithering. In order to get the true rotation of the body the dither signal has to be removed. Single stage, multistage and multirate filters are suggested to remove the dither signal. These filters have the disadvantage that either the FIR filter length is too large or the phase characteristics are not linear. In this work multiresolution techniques using Wavelet Transforms (WTs) are used to remove the dither signal. Six level multi resolution analysis is carried out with various types of wavelets like Discrete Meyer and Daubechies 45 (db45) etc. With none of the standard wavelets, the original and reconstructed signals are matched. A new wavelet is designed to remove the dither signal. The required signal can be constructed back using the approximation coefficients at level 6. The dither signal is attenuated by 265 dB, and the phase characteristics are found to be linear in the pass band. The computational complexity is also less compared to the three stage combined filter reported earlier.

Keywords—Ring Laser Gyroscope, Multiresolution,

I.INTRODUCTION

Gyroscope is basically a rotation sensor which is used to measure the absolute angular rotation of any rotating system. This instrument is an essential requirement for navigation and control of a moving vehicle. The advantage of RLG is that it is less sensitive to environmental conditions and its performance does not depend on gravity of the earth 'g'. It is also less sensitive to thermal conditions and magnetic fields. Hence it is more accurate and more stable.

Bharath Regimanu, Senior Research Assistant, Dept. of ECE
Chaitanya Bharathi Institute of Technology, Gandipet, Hyderabad, 500 075
India.

Kakarla Subba Rao, Professor, Dept. of ECE
Chaitanya Bharathi Institute of Technology, Gandipet, Hyderabad, 500 075
India

Kishore Chandra Das, Scientist F,
Research Centre Imarat(DRDO), Vignana Kancha, Hyderabad 500 069
India.

Ch.Raja Kumari, Asst. Prof, Dept. of ECE
VNRVJIET, Bachupally, Hyderabad, 500 090
India.

P.Neeharika, PG Student, Dept. of ECE
Chaitanya Bharathi Institute of Technology, Gandipet, Hyderabad, 500 075
India.

The RLG is essentially an interferometer with an active laser medium in the ring cavity to generate two propagating laser waves—one in clockwise (CW) and the other in counter clockwise (CCW) within the cavity as shown in fig.(1).

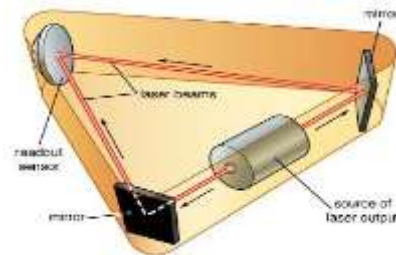

Figure.(1).Ring Laser Gyroscope

A reflector prism is used to collate the counter propagating beams to produce a stationary spatial interference pattern. The CW and CCW path lengths are same when no rotation is applied. When the laser cavity rotates a path difference ΔL exists between the two counter propagating waves and this is proportional to the difference in frequency which is called the beat frequency[1]. The beat frequency Δf is proportional to the rate of a angular rotation as given in equation.

$$\Delta f \propto \Omega$$
$$\text{or } \Delta f = K \Omega$$

where Ω the rate of rotation along the sensitive axis and K is a constant that depends on the path the RLG length, area of the ring cavity and wavelength of the laser source. When Δf is below a certain threshold value called lock-in state due to the mutual coupling of the waves, Δf becomes zero and the RLG output vanishes. To avoid the lock-in state, the RLG is vibrated mechanically in both CW and CCW directions to a high oscillating frequency which is called 'Dithering'. The dither frequency f or a given RLG is constant which is in the range of (350-500) Hz and the magnitude of the Dither signal (mechanical vibration) is about 10^4 to 10^5 times higher than the actual rotation rate of the body. In order to get the true rotation rate of the body, the Dither signal is to be removed[5]. In a typical RLG with a dither frequency of 500Hz and an amplitude of 100 arc-sec, the dither angular rate is about $90^\circ/\text{sec}$. Two types of dither removal techniques i) the dither stripping technique and ii) the use of digital filters which is relatively a new concept are used.

Both FIR and IIR filters are reported in the literature to remove the dither signal. But neither a single stage FIR nor a single stage IIR filter provide the necessary attenuation. Recently three stage combined filters (FIR&IIR) are suggested. But the phase characteristics of IIR filters are not linear. Though the attenuation achieved is above 140 dB, the phase characteristics are not linear in the pass band and also the computational comp

lexity is high[7].

II. Wavelet Transform(WT)

WT is used in many signal processing applications such as video compression, internet communications compression, object recognition etc. It can efficiently represent some signals, especially ones that have localised changes. WT can also be used in multiresolution analysis.

Even though many advanced signal processing algorithms are developed, Fourier Transform (FT) is still the basic and powerful tool even today. This is mainly for two reasons. Firstly, the FT can be efficiently implemented using FFT and secondly the FT is an eigen function of a linear time invariant system. In FT the basis function, $e^{-j2\pi ft}$, exists from minus infinity to plus infinity and the integration is over the entire time period. As a result the time information is lost and the FT gives only the global characteristics of the signal. Hence it is not suitable for the analysis of non stationary signals. But ideally in many applications we would like to compute the instantaneous FT or FT over a finite interval of time. The Short Time Fourier Transform (STFT) gives the local FT. By shifting the window in the time domain one can get the Fourier coefficients as a function of time and frequency.

The STFT of a signal $x(t)$ is given by

$$X(\tau, F) = STFT(x(t)) = \int_{-\infty}^{+\infty} x(t)W(t - \tau)e^{-j2\pi ft} dt \quad \dots (1)$$

where $W(t - \tau)$ is the window shifted by τ units.

The frequency content of the signal around time 't' is given by $X(\tau, F)$. The fixed length window is the main limitation in STFT in the time-frequency resolution. For example, for analysing transient like signals (high frequency) the window length should be small and for analysing steady state signals (low frequency), the window length should be large. In WT, the length of the window is selected depending on the frequency of the signal. In WT the signal is decomposed into a series of basis functions. All the basis functions are derived from a single parent wavelet by means of two operations -Dilation/ stretch and translation /shift. The wavelet function must have finite duration and for the inverse WT to exist, the total area under the parent wavelet must be equal to zero.

WT can also be viewed in terms of the band pass filters. An octave is a level of resolution, where each octave can be envisioned as a pair of FIR filters as shown in fig.(2).

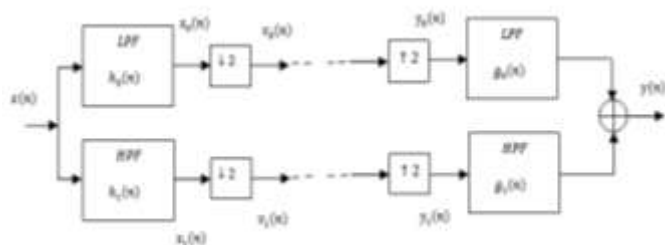

(a)Analysis filters (b)Synthesis filters

Figure.(2): One octave wavelet analysis

The down samplers and the up samplers help to reduce the re

dundancy in the data and to make the transform efficient.

The LPF produces the average signal where as the HPF produces the detail signal.

II. a) Wavelet Analysis

We know that $X_0(Z) = X(Z)H_0(Z)$ and

$$X_1(Z) = X(Z)H_1(Z)$$

The outputs of the down samplers are

$$V_0(Z) = \frac{1}{2} \left[X \left(Z^{\frac{1}{2}} \right) H_0 \left(Z^{\frac{1}{2}} \right) + X \left(-Z^{\frac{1}{2}} \right) H_0 \left(-Z^{\frac{1}{2}} \right) \right]$$

$$\text{and } V_1(Z) = \frac{1}{2} \left[X \left(Z^{\frac{1}{2}} \right) H_1 \left(Z^{\frac{1}{2}} \right) + X \left(-Z^{\frac{1}{2}} \right) H_1 \left(-Z^{\frac{1}{2}} \right) \right]$$

The outputs of the up samplers are

$$Y_0(Z) = V_0(Z^2) = \frac{1}{2} [X(Z)H_0(Z) + X(-Z)H_0(-Z)]$$

$$\text{and } Y_1(Z) = V_1(Z^2) = \frac{1}{2} [X(Z)H_1(Z) + X(-Z)H_1(-Z)]$$

The output signal $Y(Z)$ of the synthesis filter bank is given by

$$Y(Z) = \frac{1}{2} [G_0(Z)H_0(Z) + G_1(Z)H_1(Z)]X(Z) + \frac{1}{2} [G_0(Z)H_0(-Z) + G_1(Z)H_1(-Z)]X(-Z)$$

In order to get perfect reconstruction, one can choose

$$H_1(Z) = H_0(-Z), \quad G_0(Z) = -H_1(-Z), \quad \text{and}$$

$$G_1(Z) = -H_1(Z) \quad \dots (2)$$

then $y(n) = x(n - l)$

II. b) Continuous Wavelet Transform (CWT)

The CWT of the signal $x(t)$ is given as

$$W_x(a, \tau) = \int_{-\infty}^{\infty} x(t)\sqrt{a}\varphi(a(t - \tau))dt \quad (3)$$

where $\varphi(t)$ is the wavelet function shifted by τ and scaled by 'a'.

$$W_x(a, \tau) = \langle x(t), \sqrt{a}\varphi(a(t - \tau)) \rangle \quad (4)$$

The CWT can be expressed as the inner product as in eqn.(4)

The inner product can be computed by using filters. The wavelet function is given as

$$\varphi(t) = \sqrt{2} \sum_k g(k) \phi(2t - k)$$

And the scaling function $\phi(t)$ is determined through recursive application of the filter coefficients and is given by

$$\phi(t) = \sqrt{2} \sum_k h(k) \phi(2t - k) \quad \text{where}$$

$h(k)$ is the impulse response of the low pass filter and $g(k)$ is the impulse response of the high pass filter. Both $h(k)$ and $g(k)$ are of finite length.

II. c) Discrete Wavelet Transform (DWT)

A unique relation exists between the parameters of a class of perfect reconstruction octave band QMF bank (fig.2) and DWT. The scaling function allows us to have an approximation at the last level of resolution; the initial level of resolution having the input signal itself. After J levels of resolution, the result of the scaling function on the signal is zero. The scaling function or the lowpass filter output gives the approximation of the signal as given in eqn.(5).

$$A(j, n) = \sum_{m=0}^{N-1} A(j-1, m)h(2n-m), \quad j=0,1,2,\dots,(J-1) \quad (5)$$

where j is the current octave (level) and
 J is the total numbers of octaves
 n is the shift in time

The term (2n-m) incorporates scaling resulting in half the outputs for octave j compared to octave J-1.

$$\text{and } A(0,n) = x(n) \quad (6)$$

The wavelet function or the HPF output gives us the detail signal which can be recursively generated using eqn.(7)

$$D(j, n) = \sum_{m=0}^{N-1} A(j-1, m)g(2n-m) \quad (7)$$

II. d) Multiresolution

In this work multi resolution Wavelet Transform (WT) techniques are used to remove the dither signal. Multiresolution is the process of taking the output from one channel and putting it through another pair of analysis filters. Specifically, the output of LPF after down sampling at level 1 is passed through another pair of filters which produces the average and details at the next level as shown in fig.(3).

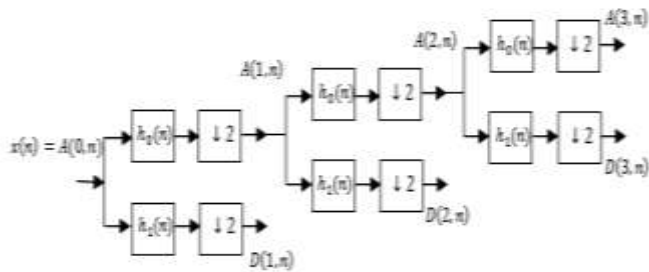

Figure.3. Three level resolution analysis filter bank

Figure shows three levels of resolution of analysis filters. The approximation coefficients A(j,n) and the detail coefficients at each level are computed using eqns.(5) and (7).

Fig.(4) shows the corresponding frequency division in each level [12]. The bandwidth of the LPF at level 3 is 0 to $\pi/8$ and that of HPF is $\pi/8$ to $\pi/4$.

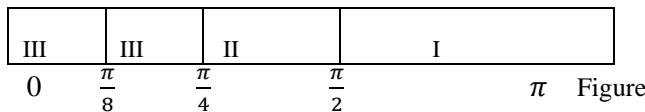

Figure.4. Frequency bands for three level analysis filter bank.

Fig. (5) shows three level synthesis filter bank which is used to reconstruct the signal back. The scaling function output at level 3 and the wavelet function outputs at all 3 levels are required to reconstruct the signal back as given in eqn.(8). That is only D(j, n), j=1 to 3 and A(3, n) are required to be stored to get the signal x1(n) back.

$$A(j, k) = \sum_{m=0}^{N-1} g_0(2k-m)A(j+1, m) + \sum_{m=0}^{N-1} g_1(2k-m)D(j+1, m) \quad (8)$$

Let $g_0(n)$ and $g_1(n)$ be the corresponding scaling and wavelet functions for the synthesis filter bank. $g_0(n)$ and $g_1(n)$ can be found from $h_0(n)$ using eq.(2).

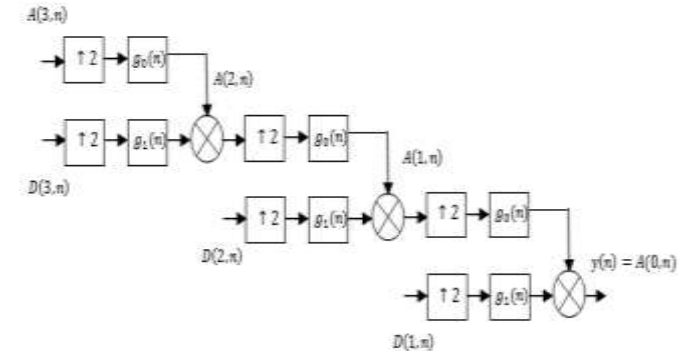

Figure.5. Three level resolution synthesis filter bank.

III) Dither filtering using WT.

The magnitude of the dither signal is about 10^4 to 10^5 times higher compared to the true rotation angle. The pass band is from 0 to 70Hz. The specifications of the signal to be filtered are given in table.

Pass band	(0 to 70)Hz
Stop band	(90 to 5000)Hz
Dither band	400Hz
Attenuation in pass band	<3dB
Attenuation in stop band	>100dB
Attenuation in dither band	≥ 160 dB
Sampling frequency	10KHz

Table 1. Specifications of the filter to be designed.

A synthetic RLG signal is generated using the MATLAB command.

$$x(t) = a1 * \sin(2 * pi * fp1 * t) + a2 * \sin(2 * pi * fp2 * t) + a3 * \sin(2 * pi * fp3 * t) + a4 * \sin(2 * pi * fp4 * t) + b1 * \sin(2 * pi * fs1 * t) + b2 * \sin(2 * pi * fs2 * t) + d * \sin(2 * pi * fd * t) \quad (9)$$

where $a1=0.000003$, $a2=0.000008$, $a3=0.000004$, $a4=0.000004$, $b1=0.0000002$, $b2=0.000002$, and $d=10$
 $fp1=5$ Hz, $fp2=20$ Hz, $fp3=35$ Hz, $fp4=55$ Hz (pass band frequencies), $fs1=95$ Hz, $fs2=120$ Hz (stop band frequencies) and $fd=400$ Hz (dither frequency)

The input signal $x(t)$ is plotted in fig.(6) and its magnitude spectrum is plotted in fig.(7). From the figures it may be observed that only 400Hz frequency is present and the other frequencies are not visible. The magnitude of the Fourier spectrum at the dither frequency(400Hz) can be measured as $2.6 * 10^{+4}$

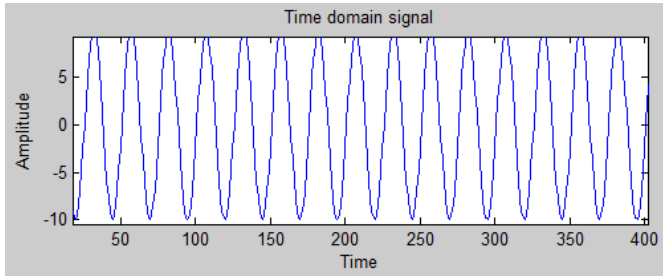

Figure.6. Input signal $x(t)$ in time domain

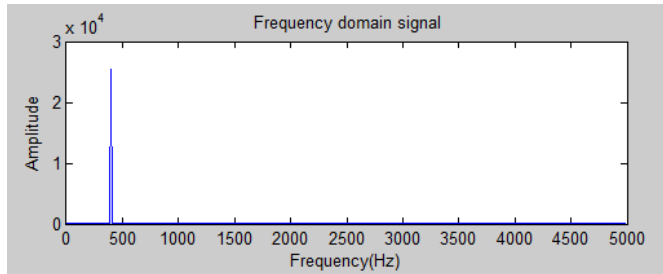

Figure.7. Magnitude spectrum of $x(t)$ in frequency domain.

The signal $x(t)$ is processed using the concept of multi resolution. As shown in fig.(3), at each octave certain band of frequencies are eliminated. Hence analysis filter bank can also be used as filter to remove the unwanted frequencies. Since the frequencies to be rejected are from 90Hz to 5KHz, six level resolution analysis is used. The frequency division diagram for the entire frequency range is shown in fig.(8). The sixth level allows the frequencies from (0 to 78)Hz which is the required pass band and all other frequencies are rejected[13]. Hence the output at level six gives the required filtered signal.

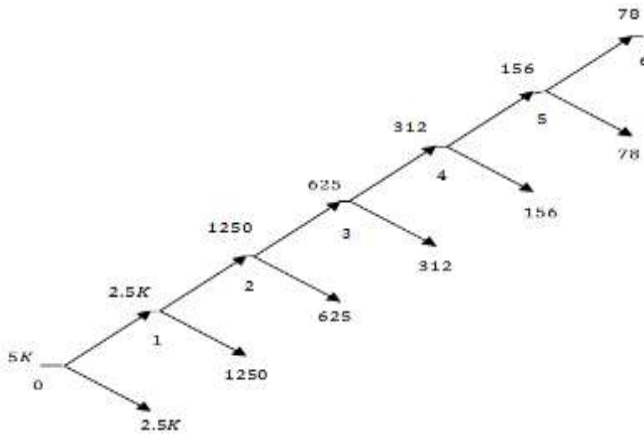

Figure.8. Six level Frequency division diagram .

Various types of orthogonal wavelets namely discrete Meyer and Daubechies 45 (db45) etc. are used to remove the dither signal. The Discrete Meyer wavelet and the corresponding scaling function are shown in Fig.(9).

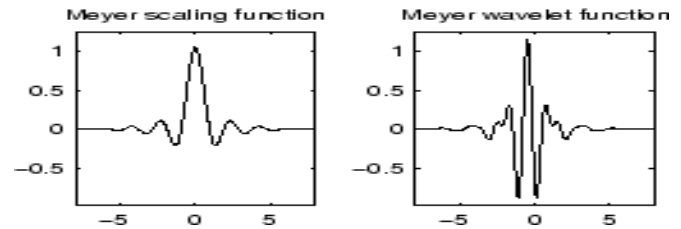

Figure.(9). Meyer scaling and wavelet function.

None of the standard wavelets are found to be suitable to remove the dither. Either some spurious frequencies are present in the spectrum or the reconstructed time signal is different from the original signal. Hence a new wavelet function is designed to remove the dither signal completely without distorting the original signal.

IV) Design of new Wavelet for dither removal

Firstly a FIR lowpass filter is designed to meet the given specifications. The best window is found to be Kaiser window and the optimal length of the filter is found to be 35. Let $h_0(n)$ be the impulse response of the low pass filter or the scaling function and the impulse response of the HPF or the wavelet function be $h_1(n)$. From wavelet theory we know that

$$h_1(n) = (-1)^n h_0(n)$$

The following properties are satisfied for the new wavelet function.

$$\langle h_0(x), h_0(n) \rangle = 1$$

$$\langle h_0(x), h_1(n) \rangle = 0$$

$$\langle h_1(x), h_1(n) \rangle = 1$$

The scaling function and the wavelet functions are orthogonal and normal or orthonormal. Both the functions are plotted in Fig.(10).

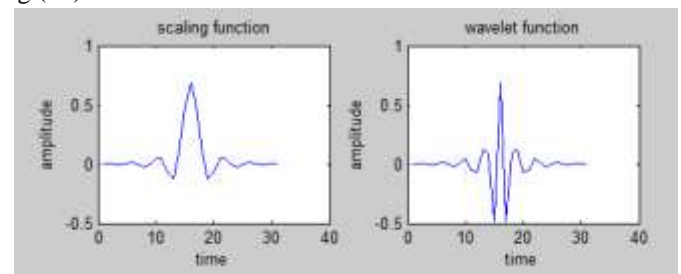

Figure.(10). Scaling and wavelet function of new wavelet.

The frequency responses of the new wavelet, discrete Meyer wavelet and Daubechies 45 are plotted in Fig.(11). It can be observed that the width of the transition band is less for the new wavelet compared to other wavelets.

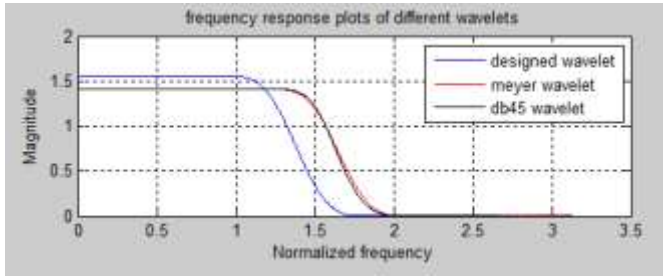

Figure.(11).Plot of Frequency Response

V) Results & Discussion

The input signal, $x(t)$, is given as input to the six octave analysis filter bank as shown in fig.(2). Note that fig.(2) shows only a three level tree. Let $h_0(n)$ and $h_1(n)$ are the scaling and wavelet functions. The approximation coefficients at level one are processed again by another pair of filters. The frequency range at level six is 0 to 78 Hz which is the required pass band signal and all other frequencies including dither are eliminated. The desired signal, $x_1(t)$, is reconstructed back using eqn.(8) and the approximation coefficients at octave 6. The original signal without dither, $x_2(t)$, is generated using the command

$$x_2(t) = a1 * \sin(2 * \pi * fp1 * t) + a2 * \sin(2 * \pi * fp2 * t) + a3 * \sin(2 * \pi * fp3 * t) + a4 * \sin(2 * \pi * fp4 * t) \quad (10)$$

The signals $x_1(t)$ and $x_2(t)$ are plotted in Fig.(12) and their Fourier spectra are plotted in Fig.(13). From the figures it is observed that there is a perfect match in both the domains. The magnitude of the Fourier spectrum at the dither frequency (400Hz) is found to be 0.1×10^{-8} (on zooming Fig.13). It means that the dither signal is attenuated by about 265 dB. Since the original signal contains only four frequencies at 5Hz, 20 Hz, 35Hz and 55Hz the spectrum of the reconstructed signal also shows four peaks at 5Hz, 20Hz, 35Hz and 55Hz respectively. This implies that the new wavelet has passed all the pass band signals (0 to 70)Hz and attenuated the dither signal as well as the stop band frequencies to the required level.

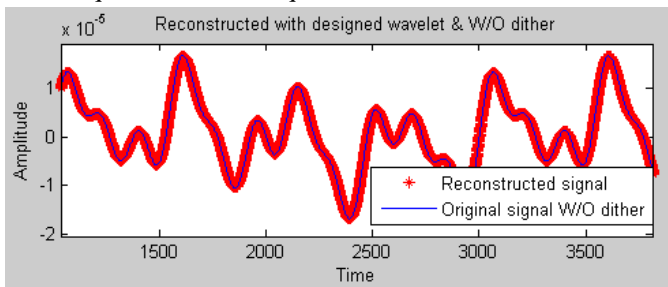

Figure.(12). Plot of Reconstructed signal.

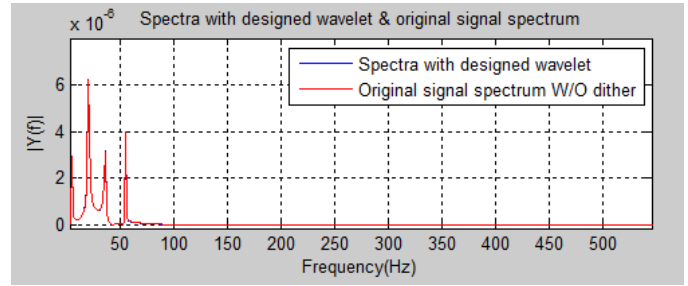

Figure.(13): Fourier spectrum of the reconstructed signal and

VI) Conclusion:

The principle of multi resolution Wavelet analysis is used to remove the dither signal. The standard wavelets like Discrete Meyer, Daubechies 45 (db45) etc. are found to be not suitable to remove the dither. Hence a new wavelet is designed. The transition band width of the new wavelet is lower than the transition band widths of discrete Meyer and db45. The new wavelet attenuates the dither signal by about 265 dB. There is a perfect agreement in the original and the reconstructed signals in both time and frequency domains.

VII) Acknowledgements:

The authors are very much thankful to the Director, RCI, Hyderabad for providing the financial support to carry out the research work.

REFERENES

- [1]. Dr. Frederick Aronowitz, "Fundamentals of the Ring Laser Gyro", 11430, Manzanita Trail, Dewey, Az 86327, U.S.A
- [2]. Neil M Barbour, John M Elwell, Roy H Setterlund, "INERTIAL INSTRUMENTS: WHERE TO NOW?", The Charles Stark Draper Laboratory, Inc. Cambridge, Massachusetts 02139
- [3]. Jeng Nan Juang and R. Radharamanan, "Evaluation of Ring Laser and Fiber Optic Gyroscope Technology", School Of Engineering, Mercer University, Macon, GA 31207 USA.
- [4]. D. Titterton and J. Weston, "Strapdown Inertial Navigation Technology", IEEE Radar, Sonar, Navigation and Avionics Series, 2nd Ed. U.K. Michael Faraday House, 2005.
- [5]. M. Faucheux, D. Fayoux and J. J. Roland, "The Ring Laser Gyro", Optics (Paris), 1988, Vol. 19, No 3, Pp. 101-115.
- [6]. Richard Choi, "Advanced Gyroscope Technology", Systems Center, San Diego, August 2008.
- [7]. K.Subba Rao, KC Das, Arjun M & Swapna P "Development of multistage digital filter for dither removal in RLG" 2nd International Conference on recent trends in Signal Processing, Image Processing & VLSI(ICrSIV-2015), Bangalore pp(872-880)
- [8]. Xi Zhang, "Design of orthogonal graph wavelet filter" IECON 2016-42nd Annula Conference of the IEEE Industrial Electronics Society. Page(s):889 - 894
- [9]. V.Vijendra, Meghana Kulkarni, "ECG signal filtering using DWT harr wavelets coefficient techniques" 2016 International Conference on Emerging Trends in Engineering , Technology and Science(ICETETS), Page(s):1 - 6
- [10]. R.Shantha Selva kumara, S.Bharathi, V.Sadasivam, "Design of Optimal Discrete Wavelet for ECG signal using Orthogonal Filter Bank" International Conference on Computational Intelligence and Multimedia Applications(ICCIMA 2007), Volume:1, Pages:525-529
- [11]. L.G.Akulov, "Wavelet filtering in Digital Signal processing Systems" 2014 International Conference on Actual problem of Electron Devices Engineering (APEDE), Pages:5-6
- [12]. Roberto Cristi, "Modern Digital Signal Processing" Thomson Books/cole
- [13]. S.K.Mitra, "Digital signal Processing" Tata Mc.Graw-Hill, 3rd edition.