

SHEAR TRANSFER IN COMPOSITE CONCRETE-CONCRETE T-SECTION

M.Rabie, W.Zaki and A.Mostafa

Abstract— the problem of shear transfer between different types of concrete surface cast at different ages has been discussed in many researches. Different types of surface treatments and shear connectors were studied experimentally to test their efficiency in what is called the (composite section) which could be formed between a precast beam and cast in place slab. In this research eleven composite concrete-concrete T-section with dimensions (beam 120*400*2000mm and slab 500*100*2000mm) were tested under static concentrated load in the middle of the span, one of them was reference monolithic T-section and the other were with different types of surface treatment like shear connectors with different lengths, epoxy and roughening also the effect of concrete strength was studied to obtain the best way to transfer the shear between concrete layers.

One of them was reference monolithic T-section and the others were with different types of surface treatment like shear connectors with different lengths, epoxy, roughening and concrete strength to obtain the best way to transfer the shear between concrete layers. Dimensions of beams were shown in Figure (1).

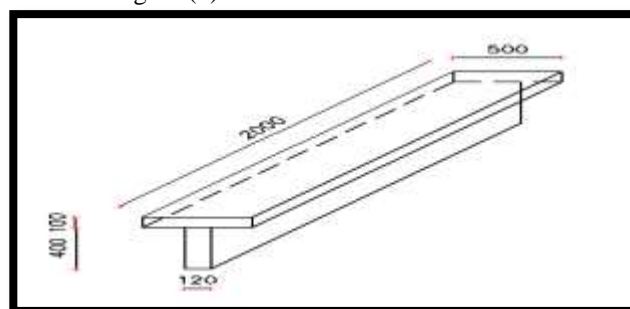

Figure (1) composite beam dimension

Keywords— Concrete, Shear Connectors, Pre-slabs, shear transfer, Interface roughness

Interface parameters were shown in Table (1)

i. Introduction

The rapid population growth in Egypt is increasing the need for housing projects, multistory garages and also for bridges rapidly constructed. Precast concrete with casts in place slab has this advantage. There is an urgent need for further investigations, laboratory tests, numerical analysis and theoretical studies to find an acceptable method for solving the problem of shear transfer along the interface between precast concrete and cast-in-place concrete to simplify dealing with such structures as the need for them is becoming urgent.

ii. Experimental work

In this research 11 composite concrete-concrete T-section with dimensions beam (120*400*2000)mms and slab (500*100*2000)mms were tested under static concentrated load in the middle of the span.

Specimen number	F_{cu} (kg/cm ²)	Interface parameter
B ₁	250	Stirrups 5 [#] 8/m
B ₂	250	Shear connectors L=6 ϕ , 5 [#] 8/m
B ₃	250	Shear connectors L=10 ϕ , 5 [#] 8/m
B ₄	250	Shear connectors L=15 ϕ , 5 [#] 8/m
B ₇	400	Shear connectors L=6 ϕ , 5 [#] 8/m
B ₈	400	Shear connectors L=10 ϕ , 5 [#] 8/m
B ₉	400	Shear connectors L=15 ϕ , 5 [#] 8/m
B ₅	250	Epoxy
B ₁₀	400	Epoxy
B ₆	250	Roughening
B ₁₁	400	Roughening

Mohamed Rabie Mahmoud
 Professor of Reinforced Concrete
 Faculty of Engineering, Cairo University.
 Egypt.

Wael Salah Eldin Zaki
 Assistant Professor
 Faculty of Engineering, Beni-Suef University
 Egypt.

Abdallah Mostafa Soliman
 Structure Engineer
 Civil Engineering, Cairo University.

All beams were reinforced concrete beam Figure (2) show the cross section and reinforced details.

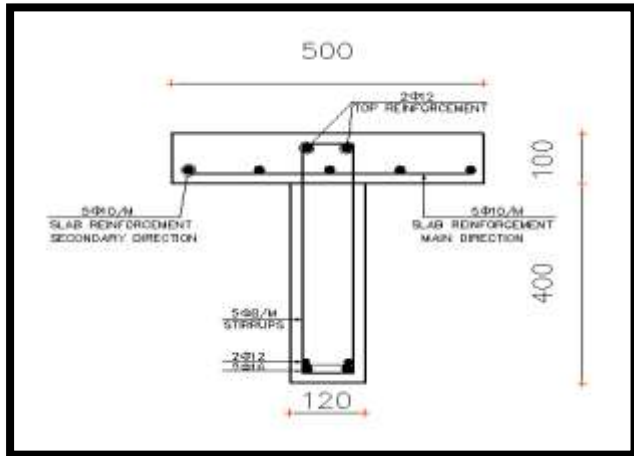

Figure (2) Beams cross section and reinforced details.

iii. Test setup and loading arrangement.

The tested beams were simply supported, the support at each edge was about 10 cms from the beginning of the beam on the available loading machine in the laboratory. All beams were loaded by concentrated loads at the middle of the span as shown in Figure (3). The pre-loading due to the own weight of beams, own weight of hydraulic jacks were constant for all beams and had been taken into consideration in the analysis. The loading rate by the jack was 2 ton per minute.



Figure (3) Beam loading

iv. Measurements.

Different types of measurements were used during testing such as:

A) Loads :

The vertical loads were applied by a hydraulic jack and measured by a load Cell; the hydraulic jack and the load cell were calibrated before testing.

B) Concrete strain :

Small steel plugs were used as a gage points for measuring concrete strain during test; they were fixed in their positions at the bottom surface of the beams by means of an adhesive material as shown in Figure (4).

A demic mechanical strain gage of 10 cm. length was used to measure the concrete strain.



Figure (4) strain points to measure the concrete strain

C) Deflection :

Two LVDT were fixed at the middle and the third of beam to measure the max deflection.



Figure (5) LVDT to measure the deflection

D) Slippage :

Two LVDT fixed by two steel angles were used to measure the max slippage as shown in Figure (6)



Figure (6) Slippage measurement

v. Discussion of Experimental Results

A summary of test result of tested composite beam is given in table (2). The results include

- A) Cracks pattern and mode of failure
- B) Max slip
- C) Max deflection

Table 2. Experimental results of tested specimens

Sample	max load(ton)	max slip(mm)	max def(mm)	max crack(mm)
B1	27.9	0	7.15	5.23
B2	27.3	1.53	7.94	7
B3	27.5	1.16	7.25	5.94
B4	27.8	0.75	7.15	5.26
B5	27.1	2.01	8.13	9.2
B6	27.5	1.72	9.3	6
B7	31.9	0.94	8.2	8.43
B8	32.7	0.79	7.73	7.4
B9	34.1	0.63	6.93	6.42
B10	31.2	1.86	9.85	11.2
B11	33.5	1.02	11.71	10

A) Crack pattern and mode of failure

For the monolithic beam, The first crack was observed nearly at the middle of the beam at load 11 t. diagonal cracks at 45° appear at load 14 t, the first crack in the slab observed at the middle at the load 23t, the diagonal cracks increase with load and reach to the supports at load 20 t as shown is Figure (7). And all beams acted as the monolithic beam and shear failure but had different values of max load as shown in table 2. only epoxy beams separated at the interface between beam and slab.

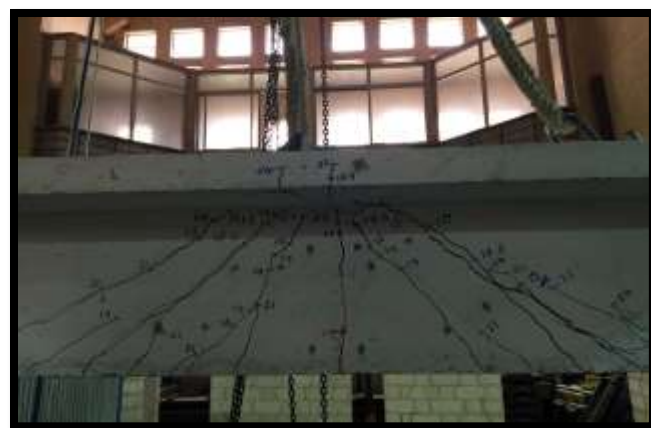

Figure (7) crack pattern for standard beam.

B) Max slip

Table (2) and Figure (8) show the value of the max slip failure the induced slip increase with the load up to failure. The rate of increase of slip with load was dependent mainly on the type of interface connection. Figure (8) show that the slip in beam5 (Epoxy, $F_{cu}=250\text{kg/cm}^2$) and beam10 (Epoxy, $F_{cu}=400\text{kg/cm}^2$) have the max slip. Also Figure (8) show that roughening interface beam 6 and beam 11 have the second max slip at failure after the epoxy interface beam5 and beam 10. Beam 4 (shear connectors $L=12\text{ cm}$, $F_{cu}=250\text{kg/cm}^2$) max slip(0.75mm) is very near to the beam 8 (shear connectors $L=8\text{cm}$, $F_{cu}=400\text{kg/cm}^2$) max slip (0.79mm). Beam 6 (Roughening, $F_{cu}=250\text{kg/cm}^2$) has max slip about 112% from the beam 2 (shear connectors $L=5\text{cm}$, $F_{cu}=250\text{kg/cm}^2$). Beam11 (Roughening, $F_{cu}=400\text{kg/cm}^2$) has max slip about 108% from the beam7(shear connectors, $L=5\text{cm}$, $F_{cu}=400\text{kg/cm}^2$). It's clear from the Figure (8) That the use of shear connectors is more effective than the use of Epoxy or Roughening.

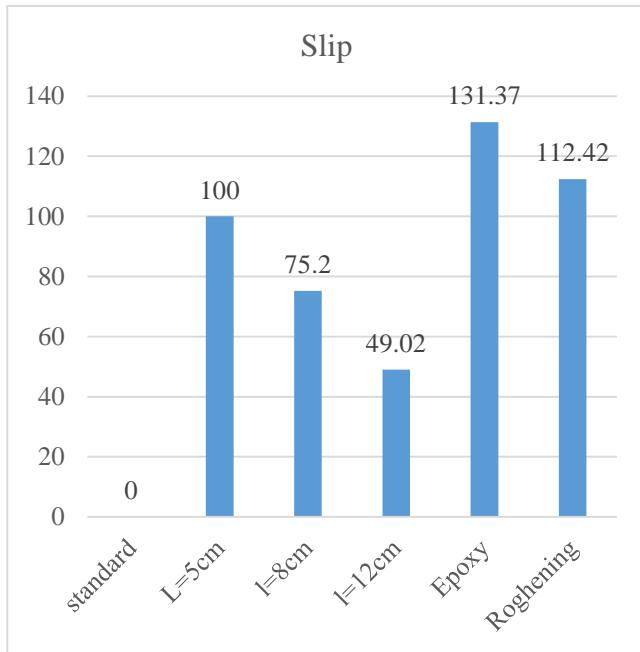

Figure (8) max slip percentage for beams had F_{cu} =250 Kg/cm².

Figure (9) shown that Increasing the concrete strength decreased the max slip at failure.

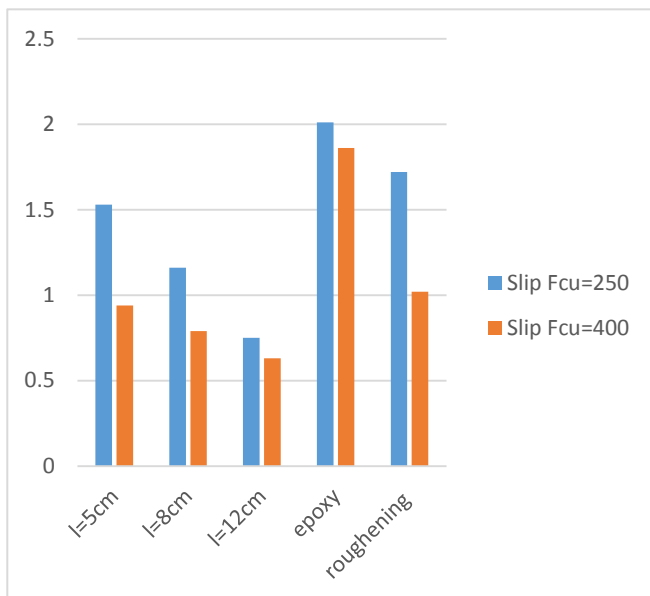
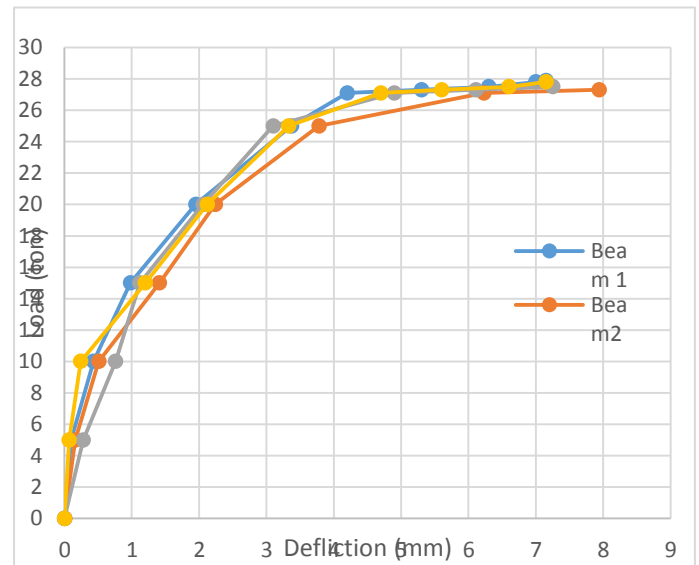

Figure (9) effect of increasing concrete strength in max slip at failure.

C) Max deflection

The mid span measured deflection of composite beams were plotted against the applied load from zero loading up to failure in Fig. (10) For beams of F_{cu}=250 kg/cm² and in Fig. (11) For beams of F_{cu}=400 kg/cm². All curves indicate that the deflection increase from zero loading up to failure.



Figure(10) load deflection diagram for beams had F_{cu} =250 Kg/cm².

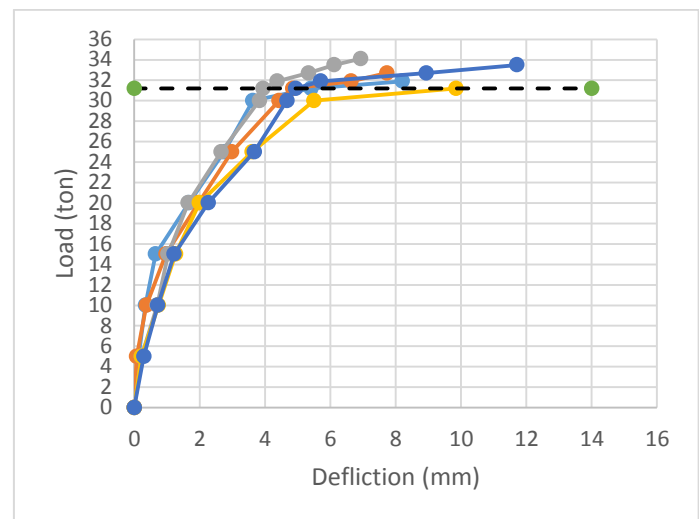

Figure (11) load deflection diagram for beams had F_{cu} =400 Kg/cm².

At load 27.1t (max load of beam 5, Epoxy, F_{cu}=250 kg/cm²) we found that beam 2(shear connectors, L=5cm) deflection is more than the monolithic beam1 by 48%, beam3 (shear connectors, L=8cm) deflection is more than the monolithic beam1 by 16%, beam4(shear connectors, L=12cm) deflection is more than the monolithic beam1 by 11%, beam5(Epoxy) deflection is more than the monolithic beam1 by 93% and beam6(Roughening) deflection is more than the monolithic beam1 by 40%.

For beams (F_{cu}=400kg/cm²) Fig.(4.11) shown that at the same load level 31.2t assuming we found that beam8(shear connectors ,L=8cm) deflection is 89% from beam7(shear connectors ,L=5cm) deflection , beam9(shear connectors , It is clear from the above discussion that the deformations of beam4 (shear connectors, L=12cm) are nearly the

same as the monolithic beam as shown in Fig. (13), Also Fig. (13) Shown that they have the same max deflection at the failure load.

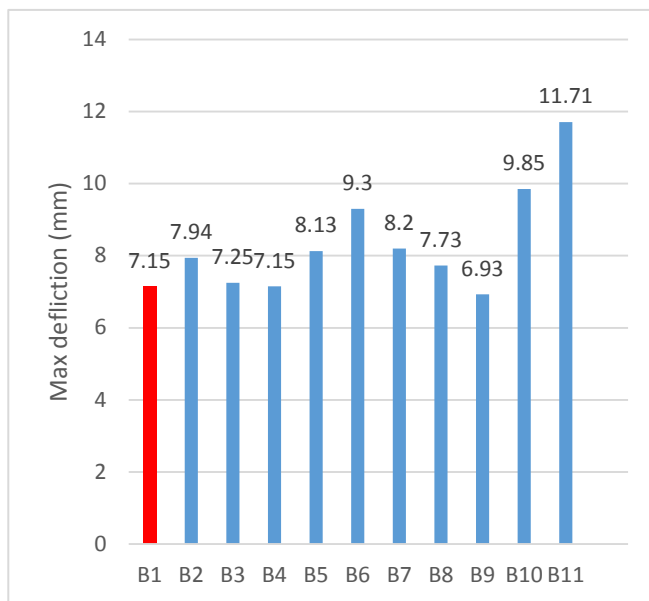

Figure (13) max deflection at failure for all beams

vi. Conclusions

We can summarize the experimental results conclusions only in three basic points.

A) Effect of shear connectors

- The best way to bond the beam with slab.
- The greater the length of the shear connectors the greater the ultimate load.
- The greater the length of the shear connectors the less the deflection.
- The greater the length of the shear connectors the less the max crack width.
- The greater the length of the shear connectors the less the slip.
- Beam 4 ($l=15\phi$) have almost the same ultimate load of the monolithic beam.

B) Effect of epoxy and roughening

- Roughening beam have the same ultimate load of beam (shear connectors, $L=10\phi$).
- Roughening beam have ultimate load about 97% of the monostich beam ultimate load.
- Roughening beam slip is about to 124% of beam 2 (shear connectors, $l=5\text{cm}$).
- Roughening beam deflection is about to 130% of the monolithic beam.
- Roughening beam max crack is about to 115% of the monolithic beam.
- Epoxy beam have ultimate load about 97% of the monostich beam ultimate load.

- Epoxy beam slip is about to 131% of beam 2 (shear connectors, $l=6\phi$).
- Epoxy beam deflection is about to 113% of the monolithic beam.
- Epoxy beam max crack is about to 175% of the monolithic beam.
- Roughening beam and epoxy beam almost have the same ultimate load.
- Slip in epoxy beam is more than the roughening beam by 7%.
- Deflection in epoxy beam is less than roughening beam by 17%.
- Max crack width in epoxy beam is more than roughening by 60%.
- Using epoxy is better than using roughening in deflection but it is worse than using roughening in slip and max crack width.

C) Effect of increase the concrete strength

- The greater the concert strength the greater the ultimate load.
- The greater the concrete strength the greater the max crack at failure
- The greater the concrete strength the less the slip at failure.
- The greater the concrete strength the greater the deflection at failure.
- Increasing the concrete strength will improve the composite action so the slip , deflection and crack width will decrease, also the ultimate load will increase.
- The best way to connect the beam with the slab can be achieved by using shear connector with length $L= 15\phi$ and increase the concrete strength.

References

- [1] Bridge Design Specifications. Washington DC. American Association of State Highway and Transportation Officials (2007). AASHTO LRFD Bridge Design Specifications. Washington DC
- [2] GOM mbH, (2008). GOM - Measuring Systems - ARAMIS. Retrieved May 4, 2008, from GOM - Optical Measuring Techniques
- [3] Mohamed Rabie, "Shear Transfer In Composite Reinforced Concrete Sections", PHD thesis, Faculty of Engineering Cairo University (1994).
- [4] W.Zaky, "Effect of cases of loading and shear connectors distribution on the behavior of One-Way composite pre-slab" Faculty of Engineering, Cairo University 2012.