

FXLMS Algorithm for Feed forward Active Noise Cancellation

Prof. Mrs. Bageshree Pathak.

Asst Prof. IEEE, IETE, ISTE Member
Electronic and telecommunication Dept
M.K.S.S. C.CO.E.W
Pune -52 ,India

Ms. Padma. P. Hirave.

Electronic and telecommunication Dept
M.K.S.S. C.CO.E.W Pune -52 ,India
Pune -52 ,India

Abstract—Two types of acoustic noise exist in the environment. One is random noise caused by turbulence and having its energy evenly across the frequency bands so referred as broadband noise, and examples are the low-frequency sounds of jet planes and the impulse noise of an explosion. Another type of noise, called narrowband noise, concentrates most of its energy at specific frequencies this is produced due to rotating or repetitive machines, so it is periodic or nearly periodic. This paper explain the feed forward Fxlms algorithm for active noise control and the noise worked here are sinusoidal tones bellow 200 Hz ,computer fan noise and ceiling fan noise .Mat lab implementation of Feed forwad FXLMS algorithm is done and result is compared for different convergence factor and different filter length of control filter.

Key words: LMS, Secondary path, Feedback Control, ANC, FXLMS

I. INTRODUCTION

There are two approaches to controlling acoustic noise: passive and active. The traditional approach to acoustic noise control uses passive techniques such as enclosures, barriers, and silencers to attenuate the undesired noise. Passive silencers use either the concept of impedance change caused by a combination of baffles and tubes to silence the undesired sound (reactive silencers) or the concept of energy loss caused by sound propagation in a duct lined with sound-absorbing material to provide the silencing

.However, they are relatively large, costly, and ineffective at low frequencies, making the passive approach to noise reduction often impractical [1,4,7,9]. Furthermore, these silencers often create an undesired back pressure if there is airflow in the duct. In an effort to overcome these problems, considerable interest has been shown in active noise control.

Broadband noise cancellation requires knowledge of the noise source i.e. the primary noise in order to generate anti sound ,whereas for narrowband noise cancellation do not require knowledge of the noise signal

Active noise control systems are based on one of two methods. Feed forward control is where a coherent reference noise input is sensed before it propagates past the canceling speaker. Feedback control is where the active noise controller attempts to cancel the noise without the benefit of an upstream reference input.

The most common algorithm applied to adaptive filters is the transversal filter using the least mean-squared (LMS) algorithm. The modified version of LMS algorithm which commonly used for ANC system are Filtered-X Least-Mean-Square (FXLMS) Algorithm, Leaky FXLMS Algorithm, Acoustic Feedback Effects and Solutions (FBFXLMS Algorithm), Filtered-U Recursive LMS (RLMS) Algorithm[11].

The filtered-X algorithm is also an adaptive filter and its weighting parameters can be automatically updated by the least mean square (LMS) algorithm. This approach is effective at attenuating lower frequency noise, such as that from a fan, compressor, or engine noise in an acoustic duct [11].

II. FEED FORWARD FXLMS

The fundamental block diagram of ANC system is as shown below.

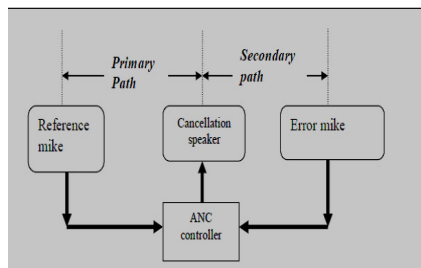

Figure 1. Fundamental block diagram of ANC

In the above block diagram

- **Primary path:** It is the acoustic path between the noise source and cancellation speaker.
- **Secondary path:** It is the electro acoustic path between the cancellation speaker and error mike.
- **Primary noise:** It is the noise to be cancelled out sensed by acoustic sensor microphone.
- **Anti phase noise:** It is the noise generated by control system and it is equal in magnitude but opposite in phase to primary noise .It drives the cancellation speaker.
- **Residual Noise:** It is the noise produced after the superimposition of primary noise

and anti phase noise in acoustic domain capture by another microphone

- **ANC controller:** The controller usually consists of an adaptive digital filter, and an adaptive algorithm that sets the weights in the adaptive digital filter. For the real time implementation DSP processor is used as controller. The control filter may be finite impulse response (FIR) or infinite impulse response (IIR).

III. SECONDARY PATH MODELING

As the channel between the cancellation speaker and error mike is the air, the transfer function between them is time varying .so it is necessary to find out secondary path transfer function each time for different place.

Assuming the characteristics of Secondary path transfer function($H(z)$) unknown but time-invariant, an off-line modeling technique can be used to estimate $H(z)$ during a training stage. At the end of training, the estimated model $C(z)$ is fixed and used for active noise control. The experimental setup for the direct off-line system modeling is shown in Figure below [9], where an uncorrelated white noise is internally generated by the DSP

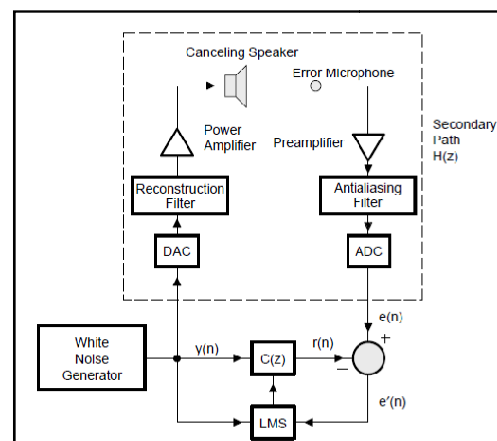

Figure 2. Offline Secondary path modeling

IV. CANCELLATION MODE

To ensure convergence of the algorithm, the input to the error correlate is filtered by a secondary-path estimate $C(z)$. This results in the filtered-X LMS (FXLMS) algorithm, to compensate for the effects of the secondary path in ANC applications. Consider the block diagram of feed forward ANC using FXLMS algorithm as shown in figure below

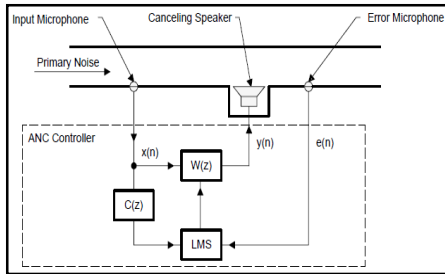

Figure 3. FXLMS Feed forward ANC

The FXLMS algorithm is explained as below [9].

Off-line modeling is conducted first to estimate the secondary-path transfer function $H(z)$ using the LMS algorithm.

1. Read the noise sample from reference mike as $x(n)$.
2. Select the order of the FIR filter and find the coefficient of adaptive filter $W(Z)$.
3. The output $y(n)$ is calculated as below

$$y(n) = W^T(n)x(n) = \sum_{i=0}^{N-1} W_i(n)x(n-i)$$

Where

$$W^T(n) = [W_0(n), W_1(n) \dots \dots W_{N-1}(n)]^T$$

Coefficient vector of $W(Z)$ at time n .

$$N = \text{Order of the FIR filter } W(Z).$$

4. $x(n) = [x(n), x(n-1) \dots \dots x(n-N+1)]^T$ is the reference signal vector at time n .
5. Update the coefficient of $W(Z)$ using below equation.

$$W_i(n+1) = W_i(n) - \mu e(n)h(n)x(n-i)$$

Where

$$x'(n) = \sum_{i=0}^{M-1} C_i(n)x(n-i)$$

$M = \text{Order of the FIR filter } C(Z)$ and

$\mu = \text{step size of algorithm}$

6. Read next N noise sample from reference mike
- 7.

Use updated coefficient of $w(n)$ from step no 4 to calculate the output $y(n)$. Repeat the step 4 to 6 till until noise cancelled out to threshold value.

V. MATLAB IMPLEMENTATION

For the mat lab implementation FIR FILTER with filter length used is 8,16 respectively and convergence factor is 0.0063. The two type of noise sample are used are 100 hz tone and ceiling fan noise each of 5sec. Following diagrams shows the result of mat lab implementation of different type of system

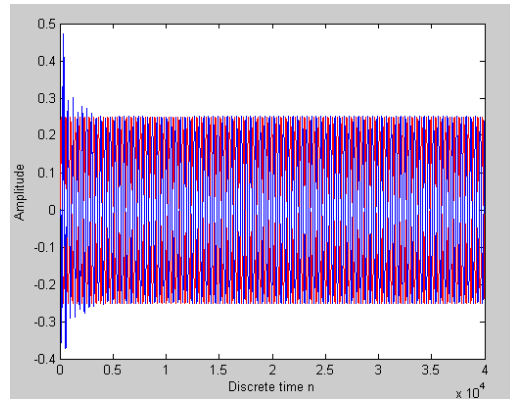

Figure 4. Noise tone Of 100 Hz and anti phase signal with filter tap length 8

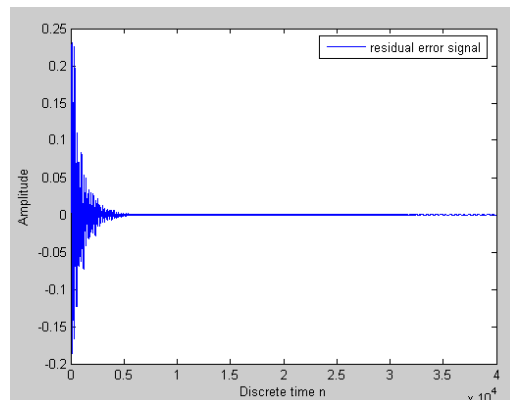

Figure. 5. Residual signal after cancellation of 100 Hz sine tone with filter tap length 8

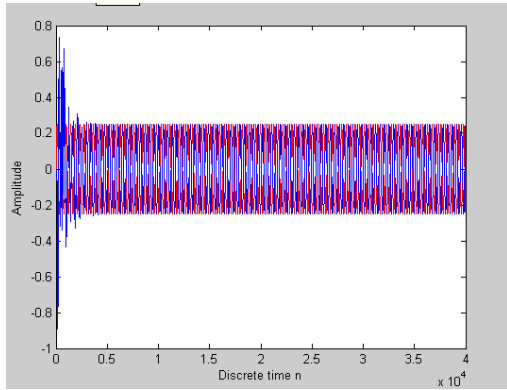

Figure 6. Noise tone Of 100 Hz and anti phase signal with filter tap length 16

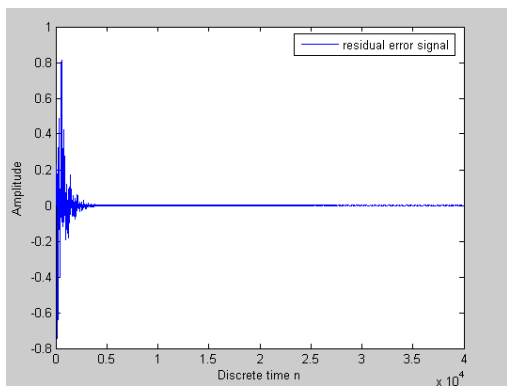

Figure 7. Residual signal afer cancellation of 100 Hz sine tone with filter tap length 16

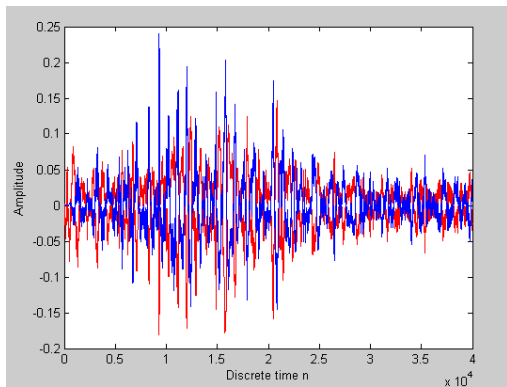

Figure 8. Fan Noise and anti phase signal with filter tap length 8

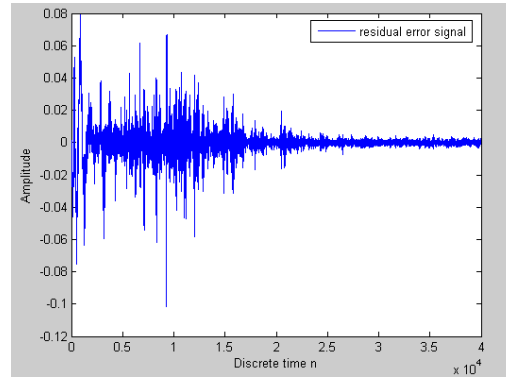

Figure 9. Residual signal afer cancellation of fan noise e with filter tap length 8

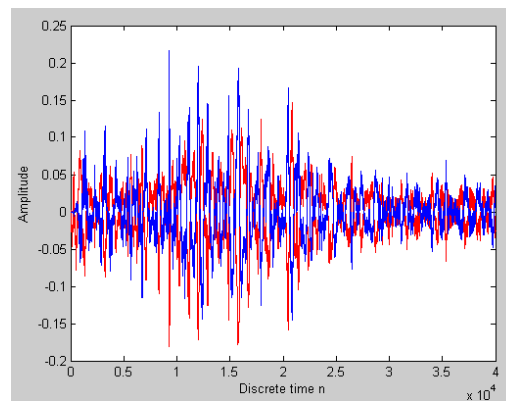

Figure 10. Fan Noise and anti phase signal with filter tap length 16

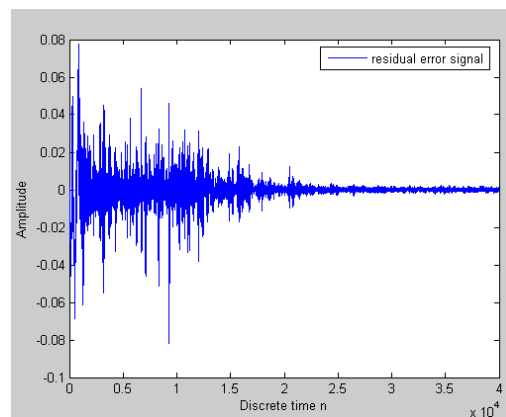
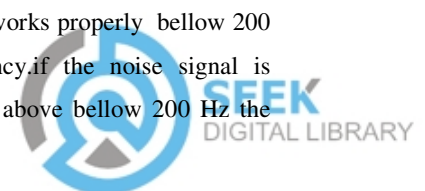

Figure 11. Residual signal afer cancellation of fan noise e with filter tap length 16

VI. CONCLUSION

The mat lab implementation of Feed forward Fxlms algorithm works properly bellow 200 Hz noise frequency.if the noise signal is having frequency above bellow 200 Hz the



system become unstable .the sampling rate used for implementation is 8000 Hz .if the filter tap length is increased from 8 to 16 then system converge earlier and become stable .

VII. REFERENCES

- [1] **Single-Sensor Active Noise Cancellation** by Alan V. Oppenheim ,Ethud Weinstein ,Kambiz C Zangi,Meir Fedar and Dan Gauger.
- [2]**Optimized Secondary Path Modeling Technique for Active Noise Control Systems** By Sen M. Kuo Department Of Electrical Engineering Northern Illinois University And Dipa Vijayan Texas Instruments, Inc.12203 S. W. Freeway Stafford,
- [3]**A Variable Step-Size FxLMS Algorithm for Feedforward Active Noise Control Systems Based On a New Online Secondary Path Modelling Technique**
Pooya Davari and Hamid Hassanpour Department of Electrical and Computer zandaran University, Shariatee Av, Babol, Iran. Faculty of Electrical Engineering, Iran University of Science and Technology
- [4]**An Adaptive Feedback Active Noise Control System**
T. G. Tsuei(l), Anu Srinivasa and Sen M. Kuo
- Ta Hwa Institute of Technology, Hsin-Chy Taiwan,Department of Electrical Engineering, Northern Illinois University, DeKalb, IL 601 15
- [5]**Optimizing Secondary Source Location in Acoustic ANC Systems**
Seyed Alireza Seyedin', Muhammad Hossein Abedi2
Department ofElectrical Engineering, Ferdowsi University ofMashhad, Mashhad, Iran
- [6]**Analysis And Design Of Narrowband Active Noise Control Systems**
Sen M. Kuo, Xuan Kong, Shaojie Chen, and Wenge Hao Department of Electrical Engineering, Northern Illinois University
- [7]**Understanding Active Noise Cancellation by Colin H Hansen.**
- [8]**Introduction to Matlab® & simulinkA project approach** Third edition BY O. Beucher And M. Weeks
- [9]**Design of Active Noise Control Systems With the TMS320 Family**
Sen M. Kuo, Ph.D., Issa Panahi, Ph.D., Kai M. Chung, Tom Horner,Mark Nadeski Jason Chyan
- [10]**Development of an Active Noise Controller in the DSP Starter Kit**
A. Miguez-Olivares, M. Recuero-Lopez
- [11]**Active Voice Control: An Implementation of Active Noise Control for Canceling Speech** by Christopher Rose