

A 2-Port Network Model of a Z-Source Converter

Bryn Parker
 Auckland University of Technology
 31-33 Symonds Street
 Auckland, NEW ZEALAND

Adam P.R. Taylor
 Auckland University of Technology
 31-33 Symonds Street
 Auckland, NEW ZEALAND

Abstract- A 2-port network model of an ideal Z-source converter has been developed and is presented in both the Z-domain and the S-domain. The reciprocity of the Z-source converter is confirmed with Z_{12} is shown to equal Z_{21} , and S_{12} is shown to equal S_{21} , and the transfer function for the Voltage Gain of the network is derived. The 2-port model is validated against a MATLAB Simscape Z-Source converter simulation and found compliant. It was shown and confirmed that an increase in inductance in the Z-source converter reduces the resonant frequency and its magnitude, while increasing capacitor values will decrease the resonant frequency of the system but as opposed to the inductor sweep the resonant magnitude increases and the phase shift bandwidth is almost unaffected. Two different configurations with the same resonant frequency were compared revealing the damping effect on the resonant frequency. The larger characteristic was found for a system with a large value of capacitance with respect to inductance (3500 μ F, 350 μ H) and the smaller characteristic is for a system where the inductance is large with respect to capacitance (350 μ F, 3500 μ H), and the role that the inductor value plays in determining the phase shift bandwidth of the system was confirmed.

I. INTRODUCTION

The Z-source converter is a new approach to power conversion that can perform dc-dc, dc-ac and ac-dc power conversion. The converter can work with either a current source or voltage source and perform both buck and boost operations. Z-source converters are proving competitive with more traditional power converter designs due to their simplicity, efficiency and versatile buck or boost implementation.

A 2-port network model is an electrical construct used as an analysis tool that allows current and voltage at one port to be related to the current and voltage at the other port by calculation and/or measurement.

This paper presents a 2-port analysis of the Z-source converter, along with a validated frequency response of the model.

II. BACKGROUND

The Z-Source Inverter

The Z-source converter[1] is a two-port X-shaped impedance network consisting of two inductors and two capacitors (Fig. 1), and can be used to couple a dc current or voltage source to a converter, inverter or load.

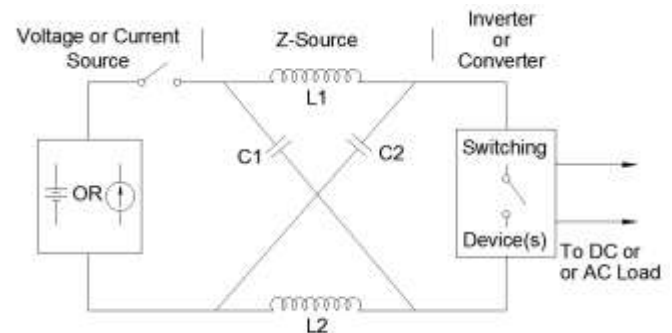

Fig. 1. Principle of the Z-Source Converter

This approach to power conversion can perform dc-dc; dc-ac and ac-dc power conversions, and therefore has an application in transformerless grid connection of photovoltaic generation[2], aircraft power generation[3], and energy recycling[4]. The Z-Source converter has a unique buck boost capability which ideally gives an output voltage range from zero to infinity regardless of the input voltage. This is achieved using a switching state that isn't permitted in the more traditional converters called the 'shoot through' state. During this state the Z-Source sees the load as a short circuit.

The Z-Source Inverter in Steady State Analysis

Analysis of the steady state operation of the Z-source converter is achieved with a simplified inverter circuit shown in Fig. 2 that assumes a balanced load and symmetry of components such that $L_1=L_2$ and $C_1=C_2$ [1].

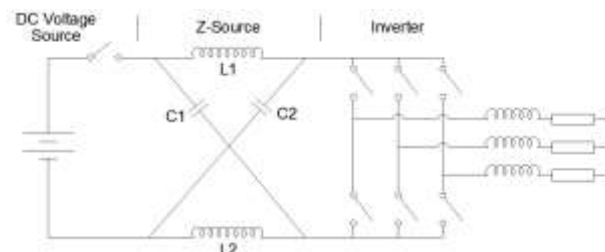

Fig. 2. A Three-phase Z-Source Bridge Inverter

Two permissible states exist in Z-Source converter operation: the 'active state' (Fig. 3) where the switch S_1 is open and Z-source converter sees the load, and the 'shoot-through-state' (Fig. 4) where S_1 is closed and the Z-source converter and the load each see a short circuit[5] and the energy stored in the capacitors is transferred to magnetic

energy in the inductors before being released in the active state for output voltage boosting.

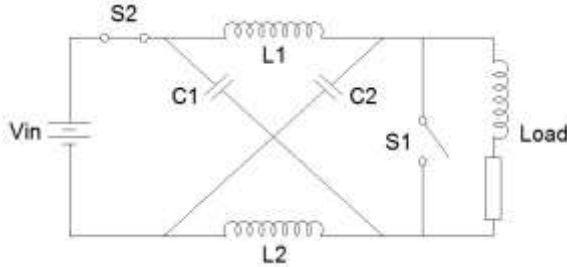

Fig. 3. A Z-Source Converter: ‘Active State’

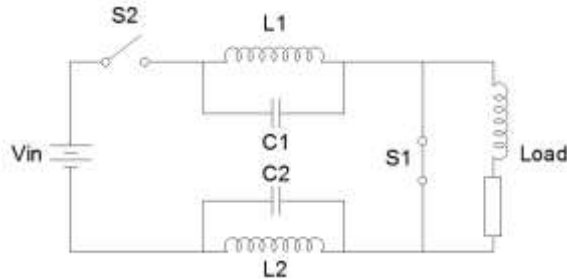

Fig. 4. Z-Source Converter: ‘Shoot Through State’

Existing steady state analysis and equations[1][5][6] show that if the Z-source is in the shoot through state for T_0 and in the active state for T_1 the period of the switching cycle can be defined as:

$$T = T_0 + T_1 \quad (1)$$

It is important to note that the average value of voltage across an inductor in the Z-source network for a switching period (T) is zero in steady state:

$$\frac{1}{T} \int_0^T v_L(t) dt = \frac{T_0 V_C + T_1 (V_{in} - V_C)}{T} = 0 \quad (2)$$

Eqn.(2) can be transposed to derive an equation for the steady state voltage across a Z-source capacitor.

$$V_{cap} = \frac{T_1}{T_1 - T_0} V_{in} = \frac{1-D}{1-2D} V_{in} \quad (3)$$

Where $D = T_0/T$ is the shoot through duty cycle and V_{in} is the steady state input voltage value. Using V_{cap} the current through the load can be calculated and thus the Z-Source inductor current.

$$I_{Load} = \frac{V_C}{R_{Load}} \quad (4)$$

$$I_L = \frac{1-D}{1-2D} I_{Load} \quad (5)$$

The Z-Source Inverter Buck and Boost Operation

The duty cycle (D) dictates the theoretical boosting capability of the Z-source converter is given in Eqn.(6), below, and shows that for $D=0$ the boosting factor (B) is equal to 1.

$$V_{S1 Peak} = 2V_C - V_{in} = \frac{1}{1-2D} V_{in} = B V_{in} \quad (6)$$

As D approaches 0.5 the denominator of B , $1-2D$ approaches 0 and the boosting factor approaches infinity. This theoretical limit means that the maximum duty cycle applied to S_1 must be less than 0.5. Accordingly, the voltage peak across S_1 can therefore be calculated.

The output peak phase voltage across the load ($V_{LoadPeak}$) of the Z-source converter can be express as:

$$V_{Load Peak} = M \frac{V_{Load Peak}}{2} \quad (7)$$

Where M is the modulation index of the inverter. Using Eqn.(6) and Eqn.(7), the following expression for $V_{LoadPeak}$, Eqn.(8), can be obtained:

$$V_{Load Peak} = MB \frac{V_{in}}{2} \quad (8)$$

Analysis of Eqn.(8) shows that the modulation index, M , has a theoretical value between 0 and 1.

The 2-Port Network

A 2-port network (Fig. 5) is an electrical construct with two pairs of terminal-pairs to connect to external circuits. This construct allows current and voltage at one port to be related to the current and voltage at the other port by calculation and/or measurement.



Fig. 5. Elementary 2-Port Network

A typical application of a 2-port network has one port as a current or voltage source and the other port is the load. The 2-port network shown in Fig. 5 shows is presented in terms of its S-domain variables I_1 , V_1 , I_2 and V_2 . Of these four terminals only two are independent and so for any circuit, once we specify two of the variables we can find the two remaining unknowns.

Developing a 2-port of the Z-source converter requires representing the two inductors and two capacitors of the impedance matrix as the 2-port network that couples the power supply to the load. Fig. 6 shows a terminated 2-port network, where V_g is the input voltage, Z_g is the input impedance and Z_L is the load. This results in six main

characteristics of the terminated 2-port network that describe its terminal behaviour:

- Input impedance $Z_{in} = V_1/I_1$
- Output current I_2
- Thevenin voltage and impedance (V_{th}, Z_{th}) with respect to port 2
- Current gain I_2/I_1
- Voltage gain V_2/V_1
- Voltage gain V_2/V_g

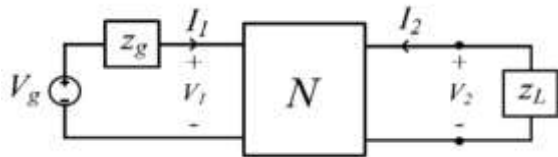

Fig. 6. Terminated 2 Port Network

For context of this study a transfer function for the Voltage gain (V_2/V_1) is derived and is presented later in Eqn. (17).

III. 2-PORT ANALYSIS

The analysis presented here was carried out on the model presented in Fig. 6. It assumed an ideal convertor with continuous current flow in the inductive load, and discontinuous current flow was not considered. Z-parameters have been used however equations for admittance, hybrid and other parameters also exist. Accordingly, $C_1=C$, $C_2=\beta C$, $L_1=L$, and $L_2=\alpha L$, where β and α are multipliers of C and L respectively.

This section shows the mathematical approach to deriving the 2-port Z parameters of a Z-Source converter. The Z-parameter equations are then converted to give their frequency domain equivalents.

$Z_{11}=V_1/I_1$ where $I_2=0$

When $I_2=0$, V_2 is open circuit and the Z-Source can be redrawn as Fig. 7, below.

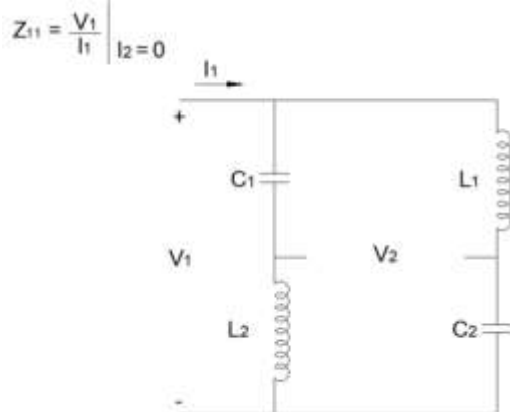

Fig. 7. Z-Source Network Z_{11}

Z parameter analysis reveals that:

$$\frac{V_1}{I_1} = \left(\frac{1}{C_1+L_2} + \frac{1}{C_2+L_1} \right)^{-1}$$

$$\frac{V_1}{I_1} = \left(\frac{C_1+C_2+L_1+L_2}{(C_1+L_2)(C_2+L_1)} \right)^{-1}$$

$$Z_{11} = \frac{V_1}{I_1} = \frac{(C_1+L_2)(C_2+L_1)}{C_1+C_2+L_1+L_2} \quad (9)$$

And in the frequency domain this is represented and resolved to Eqn.(10), below

$$\frac{V_1}{I_1} = \left(\frac{1}{\frac{1}{sC} + \alpha sL} + \frac{1}{\frac{\beta}{sC} + sL} \right)^{-1}$$

$$\frac{V_1}{I_1} = \left(\frac{sC}{\alpha s^2 LC + 1} + \frac{sC}{s^2 LC + \beta} \right)^{-1}$$

$$\frac{V_1}{I_1} = \frac{(\alpha s^2 LC + 1)(s^2 LC + \beta)}{(\alpha + 1)s^2 LC + (\beta + 1)sC}$$

$$S_{11} = \frac{V_1}{I_1} = \frac{\alpha s^4 L^2 C^2 + (\alpha\beta + 1)s^2 LC + \beta}{(\alpha + 1)s^2 LC^2 + (\beta + 1)sC} \quad (10)$$

$Z_{22}=V_2/I_2$ where $I_1=0$

When $I_1=0$, V_2 is open circuit and the Z-Source can be redrawn as Fig. 8, below.

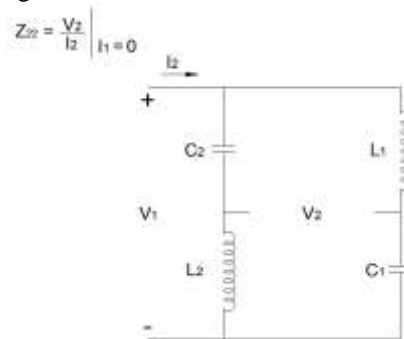

Fig. 8. Z-Source Network Z_{22}

Z parameter analysis reveals that:

$$\frac{V_2}{I_2} = \left(\frac{1}{C_2+L_2} + \frac{1}{C_1+L_1} \right)^{-1}$$

$$\frac{V_2}{I_2} = \left(\frac{C_1+C_2+L_1+L_2}{(C_2+L_2)(C_1+L_1)} \right)^{-1}$$

$$Z_{22} = \frac{V_2}{I_2} = \frac{(C_2+L_2)(C_1+L_1)}{C_1+C_2+L_1+L_2} \quad (11)$$

And in the frequency domain this is represented and resolved to Eqn.(12), below:

$$\frac{V_2}{I_2} = \left(\frac{1}{\frac{1}{SC} + SL} + \frac{1}{\frac{\beta}{SC} + \alpha SL} \right)^{-1}$$

$$\frac{V_2}{I_2} = \left(\frac{SC}{S^2LC + 1} + \frac{SC}{\alpha S^2LC + \beta} \right)^{-1}$$

$$\frac{V_2}{I_2} = \frac{(S^2LC + 1)(\alpha S^2LC + \beta)}{(\alpha + 1)S^2LC + SC(\beta + 1)}$$

$$S_{22} = \frac{V_2}{I_2} = \frac{\alpha S^4 L^2 C^2 + (\alpha + \beta)S^2 LC + \beta}{(\alpha + 1)S^2 LC^2 + SC(\beta + 1)} \quad (12)$$

$Z_{21} = V_2/I_1$ where $I_2=0$

$$Z_{21} = \frac{V_2}{I_1} \Big|_{I_2=0}$$

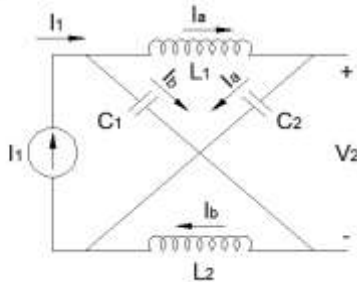

Fig. 9. Z-Source Network Z_{21}

Z parameter analysis reveals that:

$$V_2 = C2Ia - L2Ib$$

$$V_2 = C2Ia - L2(I1 - Ia)$$

$$V_2 = (C2 + L2)Ia - L2I1$$

$$Ia = \left(\frac{C1 + L2}{C1 + C2 + L1 + L2} \right) I1$$

$$Z_{21} = \frac{V_2}{I_1} = \frac{(C2 + L2)(C1 + L1)}{C1 + C2 + L1 + L2} - L2 \quad (13)$$

And in the frequency domain this is represented and resolved to Eqn.(14), below:

$$V_2 = \left(\frac{\beta}{SC} + \alpha SL \right) Ia - I1\alpha SL$$

$$V_2 = \left(\frac{\alpha S^2 LC + \beta}{SC} \right) Ia - I1\alpha SL$$

$$Ia = \left(\frac{\frac{1}{SC} + \alpha SL}{\frac{1}{SC} + \frac{\beta}{SC} + \alpha SL + SL} \right) I1$$

$$Ia = \left(\frac{\alpha S^2 LC + 1}{(\alpha + 1)(S^2 LC) + \beta + 1} \right) I1$$

$$V_2 = \left(\frac{\alpha S^2 LC + \beta}{SC} \right) \left(\frac{\alpha S^2 LC + 1}{(\alpha + 1)(S^2 LC) + \beta + 1} \right) I1 - I1\alpha SL$$

$$S_{21} = \frac{V_2}{I_1} = \frac{\alpha^2 S^4 L^3 C^2 + (\beta + 1)(\alpha S^2 LC) + \beta}{(\alpha + 1)(S^2 LC^2) + SC(\beta + 1)} - \alpha SL$$

$$S_{21} = \frac{-\alpha S^4 L^2 C^2 + \beta}{(1 + \alpha)S^2 LC^2 + (\beta + 1)SC} \quad (14)$$

$Z_{12} = V_1/I_2$ where $I_1=0$

$$Z_{12} = \frac{V_1}{I_2} \Big|_{I_1=0}$$

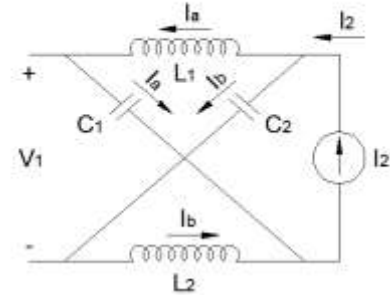

Fig. 10. Z-Source Network Z_{12}

Z parameter analysis reveals that:

$$V_1 = C1Ia - L2Ib$$

$$V_1 = C1Ia - L2(I2 - Ia)$$

$$V_1 = (C1 + L2)Ia - L2I2$$

$$V_2 = \left(\frac{1}{SC} + \alpha SL \right) Ia - I2\alpha SL$$

$$V_2 = \left(\frac{\alpha S^2 LC + 1}{SC} \right) Ia - I2\alpha SL$$

$$Ia = \left(\frac{C2 + L2}{C1 + C2 + L1 + L2} \right) I2$$

$$Z_{12} = \frac{V_2}{I_2} = \frac{(C2 + L2)(C1 + L1)}{C1 + C2 + L1 + L2} - L2 \quad (15)$$

And in the frequency domain this is represented and resolved to Eqn.(16), below:

$$Ia = \left(\frac{\frac{\beta}{SC} + \alpha SL}{\frac{1}{SC} + \frac{\beta}{SC} + \alpha SL + SL} \right) I2$$

$$Ia = \left(\frac{\alpha S^2 LC + \beta}{(\alpha + 1)(S^2 LC) + \beta + 1} \right) I2$$

$$V_1 = \left(\frac{\alpha S^2 LC + 1}{SC} \right) \left(\frac{\alpha S^2 LC + \beta}{(\alpha + 1)(S^2 LC) + \beta + 1} \right) I2 - I2\alpha SL$$

$$S_{12} = \frac{V_2}{I_2} = \frac{\alpha^2 S^4 L^2 C^2 + (\beta + 1)(\alpha S^2 LC) + \beta}{(\alpha + 1)(S^2 LC^2) + (\beta + 1)SC} - \alpha SL$$

$$S_{12} = \frac{-\alpha S^4 L^2 C^2 + \beta}{(1 + \alpha)S^2 LC^2 + (\beta + 1)SC} \quad (16)$$

From inspection of the above equations it can be seen that Eqn.(15) resolves to the same as Eqn.(13), and therefore $Z_{12} = Z_{21}$. Likewise Eqn.(16) resolves to the same as Eqn.(14), therefore $S_{12} = S_{21}$. This relationship between the parameters means that the Z-source Network is reciprocal, and therefore only three calculations or parameters are required to determine

a set of parameters, where $L_1=L_2$ and $C_1=C_2$ i.e. the component multipliers $\alpha=\beta=1$ then $Z_{22}=Z_{11}$ and $S_{22}=S_{11}$.

In this case the Z-source network is symmetrical and its terminals can be interchanged without disturbing the values of currents or voltages. For a symmetric reciprocal network only two calculations or measurements are necessary to determine all the 2-port parameters.

Having calculated the Z-parameters in the frequency domain the following relationships can be used to acquire the transfer function, Eqn. (17), for the Voltage Gain of the network.

$$\frac{V_2}{V_1} = \frac{S_{21}S_L}{S_{11}S_{Load} + \Delta S} \quad (17)$$

where

$$\Delta S = S_{11}S_{22} - S_{12}S_{21} \quad (18)$$

2-Port Network Frequency Response

MATLAB was used to validate the Voltage gain transfer function in Eqn.(17) against a Z-Source simulation using MATLAB Simscape for consistency. For a Z-Source converter with a 10Ω , 3mH load, voltage gain frequency response bode plots were created for analysis. Note that all bode plots within this text are for symmetrical Z-Source networks.

The voltage gain of a Z-Source converter for a fixed capacitor value of $380\mu\text{F}$ with different inductor values $3500\mu\text{H}$, $350\mu\text{H}$ and $35\mu\text{H}$ is seen in Fig. 11, below.

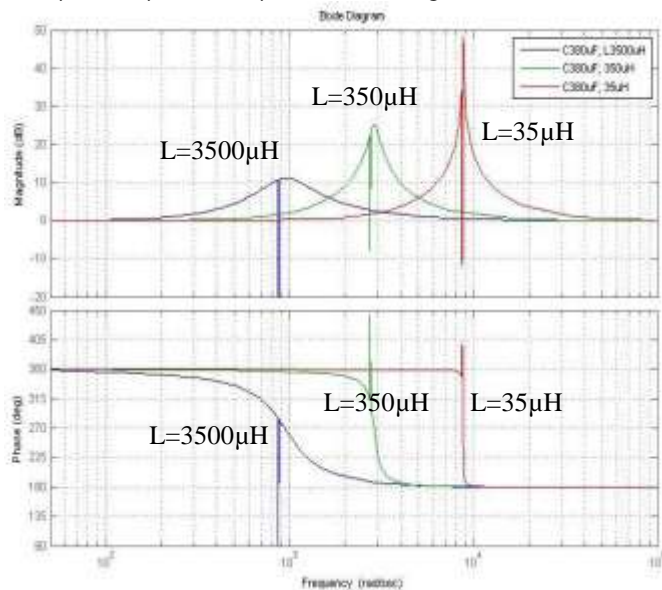

Fig. 11. Voltage Gain Bode– Inductor Sweep

Large variations in inductor values were used to amplify the affects it has on the frequency response. From Fig. 11 it can be observed that an increase in inductance reduces the resonant frequency and its magnitude. The effect of inductance on the phase shift characteristic should also be noted with the

bandwidth encompassing the 180° phase shift increasing with inductance.

A capacitor sweep with $L=350\mu\text{H}$ and $C=380\mu\text{F}$, $600\mu\text{F}$ and $1000\mu\text{F}$, is shown in Fig. 12, revealing that increasing capacitor values decrease the resonant frequency of the system but as opposed to the inductor sweep the resonant magnitude increases and the phase shift bandwidth is almost unaffected.

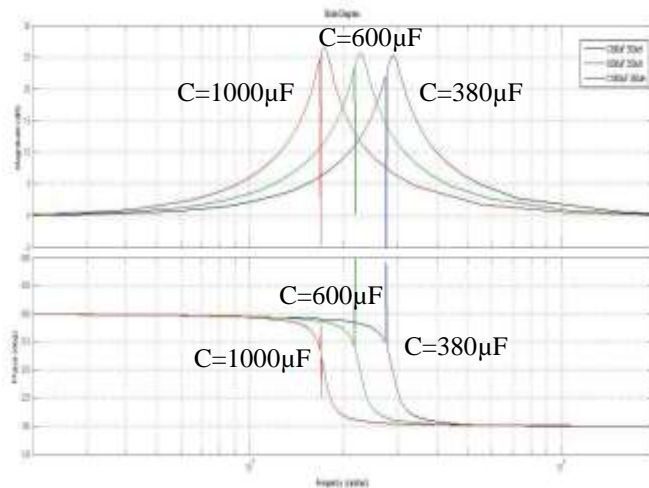

Fig. 12. Voltage Gain Bode – Capacitor Sweep 22

Two different configurations with the same resonant frequency are compared in Fig. 13, revealing the damping effect on the resonant frequency. The larger characteristic is for a system with a large value of capacitance with respect to inductance ($3500\mu\text{F}$, $350\mu\text{H}$) and the smaller characteristic is for a system where the inductance is large with respect to capacitance ($350\mu\text{F}$, $3500\mu\text{H}$).

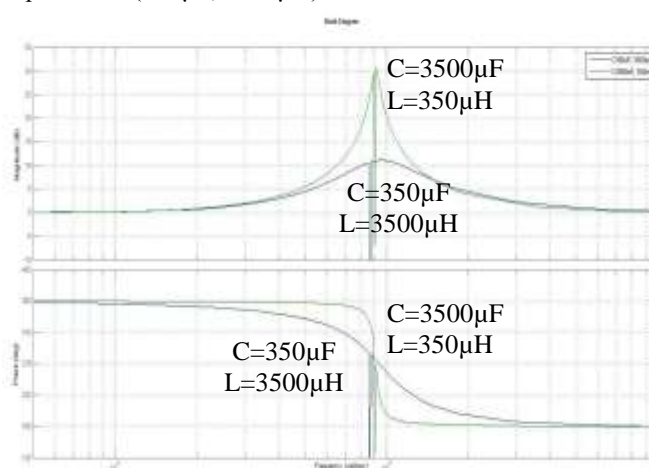

Fig. 13. Voltage Gain Bode – Comparison

When comparing the phase shift characteristics its clear the role that the inductor value plays in determining the phase shift bandwidth of the system. Eqn.(19) corresponds to the peaks of the large humps where resonance of the Z-Source converter occurs.

$$\omega_0 = \frac{1}{\sqrt{LC}} \quad (19)$$

The nature of the spikes close to the peaks of the resonance humps is unknown however it's thought to be a numerical imprecision in MALAB.

IV. CONCLUSIONS

The 2-port network model of an ideal Z-source convertor was developed and presented in both the Z-domain and the S-domain. The reciprocity of the Z-source convertor was confirmed with Z_{12} is shown to equal Z_{21} , and S_{12} is shown to equal S_{21} , and the transfer function for the Voltage Gain of the network was derived. The 2-port model is validated against a MATLAB Simscape Z-Source convertor simulation and found compliant.

The 2-port model was shown to be:

$$Z_{11} = \frac{V_1}{I_1} = \frac{(C1+L2)(C2+L1)}{C1+C2+L1+L2} \quad (9)$$

$$S_{11} = \frac{V1}{I1} = \frac{\alpha S^4 L^2 C^2 + (\alpha\beta + 1) S^2 LC + \beta}{(\alpha + 1) S^2 LC^2 + (\beta + 1) SC} \quad (10)$$

$$Z_{22} = \frac{V1}{I1} = \frac{(C2+L2)(C1+L1)}{C1+C2+L1+L2} \quad (11)$$

$$S_{22} = \frac{V2}{I2} = \frac{\alpha S^4 L^2 C^2 + (\alpha + \beta) S^2 LC + \beta}{(\alpha + 1) S^2 LC^2 + SC(\beta + 1)} \quad (12)$$

$$Z_{21} = \frac{V2}{I1} = \frac{(C2+L2)(C1+L1)}{C1+C2+L1+L2} - L2 \quad (13)$$

$$S_{21} = \frac{-\alpha S^4 L^2 C^2 + \beta}{(1 + \alpha) S^2 LC^2 + (\beta + 1) SC} \quad (14)$$

$$Z_{12} = \frac{V2}{I2} = \frac{(C2+L2)(C1+L1)}{C1+C2+L1+L2} - L2 \quad (15)$$

$$S_{12} = \frac{-\alpha S^4 L^2 C^2 + \beta}{(1 + \alpha) S^2 LC^2 + (\beta + 1) SC} \quad (16)$$

and the transfer function of the 2-port model of the Z-source convertor was shown to be: where

$$\frac{V_2}{V_1} = \frac{S_{21} S_L}{S_{11} S_{Load} + \Delta S} \quad (17)$$

$$\Delta S = S_{11} S_{22} - S_{12} S_{21} \quad (18)$$

It was shown and confirmed that an increase in inductance in the Z-source convertor reduces the resonant frequency and its magnitude, while increasing capacitor values will decrease the resonant frequency of the system but as opposed to the inductor sweep the resonant magnitude increases and the phase shift bandwidth is almost unaffected.

Two different configurations with the same resonant frequency were compared revealing the damping effect on the resonant frequency. The larger characteristic was found for a system with a large value of capacitance with respect to inductance (3500µF, 350µH) and the smaller characteristic is for a system where the inductance is large with respect to capacitance (350µF, 3500µH), and the role that the inductor value plays in determining the phase shift bandwidth of the system was confirmed.

REFERENCES

- [1] Peng, F.Z., "Z-Source Inverter", *IEEE Transactions on Industry Applications*, 39(2), pp. 504–510, March–April 2003.
- [2] Farhangi, B., Farhangi, "Application of Z-Source Converter in Photovoltaic Grid-Connected Transformer-Less Inverter" *Journal of Electrical Power Quality and Utilization* Vol.12(2) (2006), pp 41-45
- [3] Khlebnikov, A.S., Kharitonov, S.A., "Application of the Z-source converter for aircraft power generation systems", 9th International Workshop and Tutorials on Electron Devices and Materials, 2008. EDM 2008. Date of Conference: 1-5 July 2008 pp. 211 - 215
- [4] Rosas-Caro, J.C., Peng, F.Z., Cha, H., Rogers, C., "Z-Source-Converter-Based Energy-Recycling Zero-Voltage" *IEEE Transactions on Industrial Electronics* - vol. 56(12) pp. 4894-4902, 2009
- [5] Sen, G., Elbuluk, M., "Voltage and Current Programmed Modes in Control of the Z-Source Converter", *IEEE Industry Applications Society Annual Meeting*, Edmonton, Alberta, Canada, pp. 1-8, 2008.
- [6] Liu, J., Hu, J., Xu, L., "Dynamic Modeling and Analysis of Z-Source Converter — Derivation of AC Small Signal Model and Design-Oriented Analysis", *IEEE Transactions on Power Electronics*, vol. 22, no. 5, Sept. 2007, pp. 1786-1796.