

The Effect of LED Chip Connection Type on Lighting and Thermal Performance of A Luminaire

[Hakan Akca, Huseyin Akdemir, Ramazan Ayaz, Ali Ajder, Ismail Nakir, Mugdesem Tanrioven]

Abstract—LED Lighting system is an alternative to conventional lighting system for their special advantages in terms of power rating, lifetime, luminous efficacy, etc. This paper proposes the results obtained from a DC/DC converter powered LED streetlight system. In this study, high and low voltage output DC/DC converter is used for operating serial and parallel connected LED modules. The effects of connection type and output voltage are presented to verify the effectiveness on LED driver in terms of thermal, electrical and lighting aspects. Then it is shown that thermal and optical performance is better in serial connection, reliability performance is better on the parallel connection

Keywords—connection type, luminaire, LED drivers, streetlight

I. Introduction

In recent years, using of LEDs has been increasing due to their high efficiency factor, more than 100000 hours operating time [1], -20°C to 120°C operation temperature [2] and availability of different colors [3]. Although, LEDs have superior features, there are some operational factors that delimit LEDs performance such as junction temperature [4], electrical resistance [5] and connection type [6] of LED modules.

The luminous flux of LED is directly related to their current. If the same light output is desired, each LED chip is connected in series for producing similar light output [7]. When many LEDs are connected in series, output voltage limited out of the LED driver [8]. When serial connection is used, LED luminaire system is not sustainable. Because, all LED are off if one LED break down in series connection. On the other hand, LEDs connected in parallel, current sharing problem is occurred between the LED branches due to characteristic [9], aging [8], and thermal resistance of LED chip. There is some different method for overcome to current sharing problem [6].

Thermal management is an important issue [10], because thermal resistance and characteristic of LED are affected negatively from the temperature. In addition to this, thermal conditions have an effect on the LED thermal [11] and reliability [12] performance.

Generally, studies focused on improving lighting efficiency of LED luminaire. In this study connection type of LED chips are investigated. Thermal, optical and electrical performance is benchmarked and presented.

The paper is organized as follows. The analyzing the impact of led modules connection type on is shown in Section II. The details of the experimental study and results are presented in Section III, and the conclusion is given in Section IV.

II. Analyzing the Impact of Led Modules Connection Type on Luminaries

LED luminaries are widely used industrially on road lighting. Designs are made so as to obtain the best performance thermally, electrical and optical. High-power LED luminaires are made by using many LED chips. These chips are connected to obtain desire lighting value by connecting in different connection types [7]. Depending on the type of connection used; electrical, thermal, optical and reliability properties would vary. These features will be discussed in the next section.

LED luminaires are made by using parallel or serial connection type of LED chips. In this paper, LED chips are used in groups called as 'module'. Each module contains serial connected 12 LED chips. The luminaire consists of 4 modules and its nominal power is 150W. LED modules are named as A, B, C and D in order to clarify of analysis. The luminaire power is kept constant at 150W both series and parallel connection.

Fig. 1 shows a configuration of the parallel-connected modules for the LED luminaire.

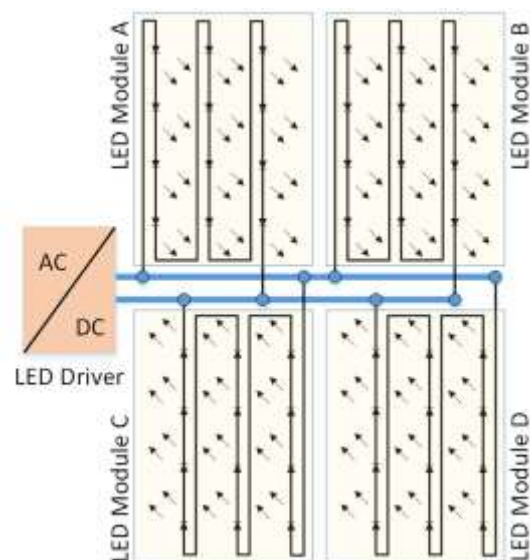

Figure 1. Parallel connected module configuration of the LED luminaire.

Hakan Akca, Huseyin Akdemir, Ramazan Ayaz, Ali Ajder, Ismail Nakir, Mugdesem Tanrioven

Yildiz Technical University, Department of Electrical Engineering
Turkey

Fig. 2 shows a configuration of the serial-connected modules for the LED luminaire.

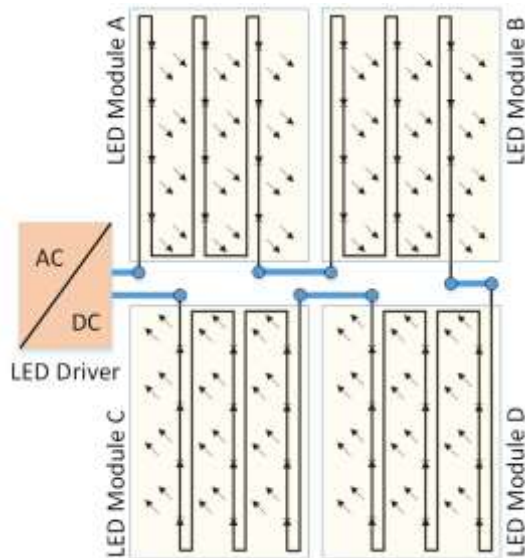

Figure 2. Serial connected module configuration of the LED luminaire.

LED chip is modeled as an electrical and thermal resistance, as is shown in Fig. 3. However, these resistance values [8] of the LED chips are not equal because of production conditions. As a result of this inequality, since different currents flow from the parallel module, the light flux and temperature of each module would be different. These differences would affect directly to the luminaire's output.

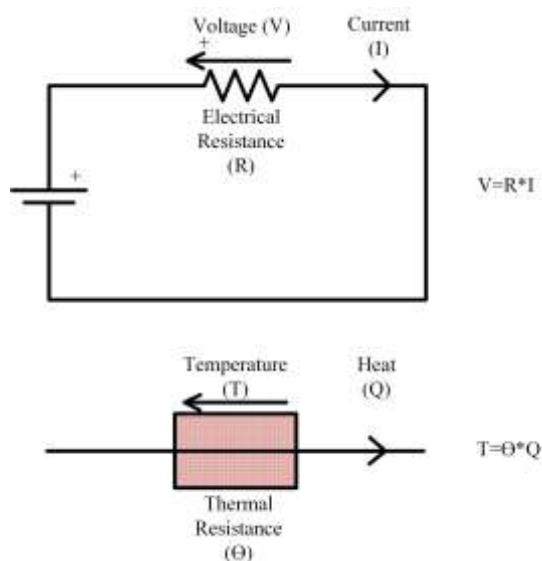

Figure 3. Electrical and thermal equivalent circuit of LED.

III. Experimental Study and Results

In this section, electrical, optical and thermal analysis of parallel and serial connected LED modules were performed. For this purpose, the experimental setup was proposed as is shown in Fig. 4.

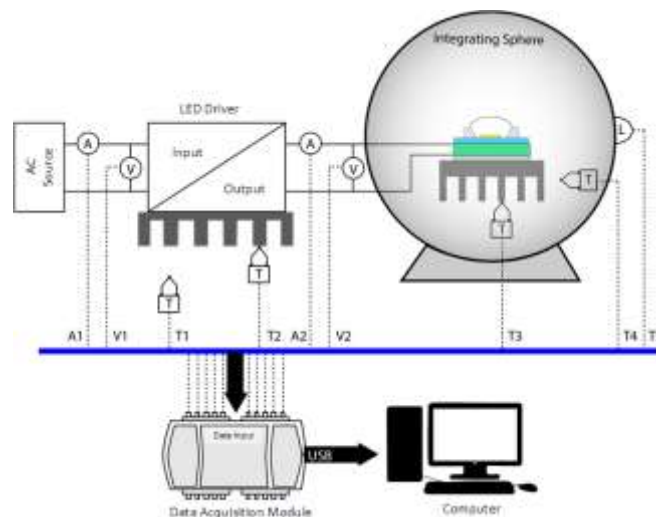

Figure 4. Experimental setup of LED luminaire test system.

Firstly, the performance of the LED driver which has 150W nominal power was analyzed. Driver's efficiency and luminaire's power were calculated by reading electrical parameters of the driver. Also driver's input-output current and voltage, system temperature and efficiency, luminous flux data were stored in the computer via a data acquisition card simultaneously. For luminous flux measurement, an integrating sphere was used as is shown in Fig. 5.



Figure 5. Integrating sphere.

Data were analyzed and then results were compared to validate the effect of serial and parallel connection of the modules on the Led luminaire. Results were plotted and illustrated in Fig. 6.

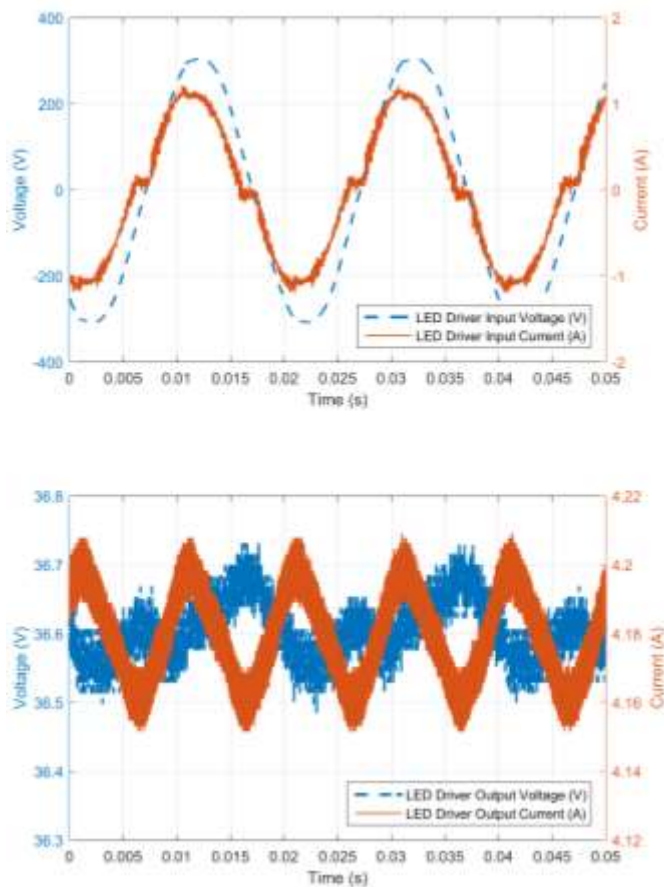

Figure 6. LED Driver input and output current-voltage characteristic.

The LED driver input current includes harmonics component which I_{thd} value is 2.13%. PFC method was used to assimilate the input current as sinus. The drive output current value is (I_{mean}) 3.93A. Constant current method was used to keep output current at stationary value. In addition to this, LED driver's electrical values were given detailed in Table. 1.

TABLE I. LED DRIVER'S ELECTRICAL VALUES

V_{rms}	V_{thd}	I_{rms}	I_{thd}	V_{mean}	I_{mean}	P_{in}	P_{out}	Efficiency
220	1.6	0.76	13.2	39.35	3.93	163.3	154.6	94.6

Then, connection types of the LED modules were changed, after analyzing of the LED driver. Respectively parallel and series connection conditions of LED modules were investigated. Optical and electrical values of the luminaires for both of connection type were presented in Table 2.

TABLE II. OPTICAL AND ELECTRICAL VALUES OF THE LUMINARIES

Type	V_{out}	I_{out}	P_{out}	lm	lm/w
Parallel	39.35	3.93	154.6	15440	99.87
Series	147.3	1.03	151.72	17100	112.70

In here, remarkable point is that luminous flux (lm) of the serial connection is higher than the parallel connection. As a result of this luminous efficacy (lm/W) is greater about

11.3%, too. This ratio is significant value in terms of energy efficiency.

Current values shown in Table 2 indicate the total current of modules. While the same current flows all modules on serial connection, different current flows which inversely proportional to the internal resistance of modules. To find out these current differences, each 4 module's current measured on separately in case of parallel connection. These modules called as A, B, C and D on clockwise. Measurements have shown that the different current flows of each module. This situation is presented in Fig. 7.

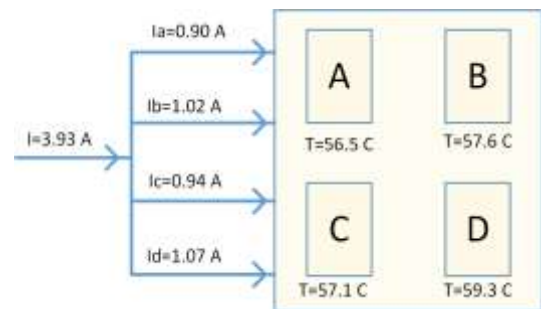

Figure 7. LED module currents and temperature distribution on parallel connection.

Unbalance of current sharing prevents homogeneous thermal radiation. Therefore, temperature is greater where the current is high. This is supported by thermal camera measurements, and is given in Fig. 8.

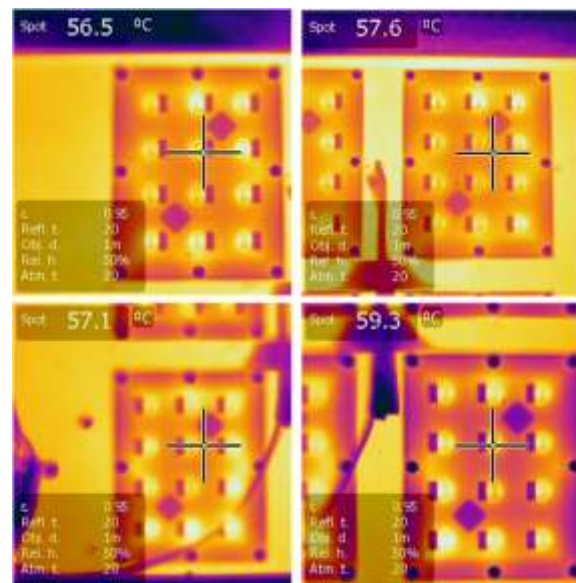

Figure 8. Thermal images of LED modules on parallel connection.

As seen in the Fig. 8, it is not uniform temperature distribution on the luminaire. While module 'D' which current flow is the highest (1.07A) has the maximum temperature (59.3°C), Module 'A' which current flow is the lowest (0.90A) has the minimum temperature (56.5°C). The same test procedure performed on serial connection. In serial condition, the total current flow measured as 1.03A from the LED driver and is given in Fig. 9.

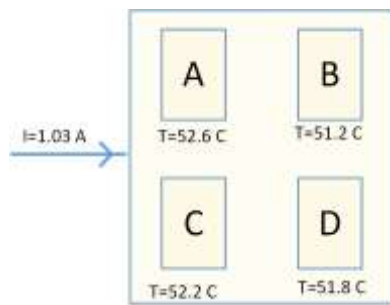

Figure 9. LED module currents and temperature distribution on the serial connection.

In serial connection, because there is the same current value on all modules, the temperature on the luminaires is the same on all points. On the Fig. 10, there are images from taken by the thermal camera.

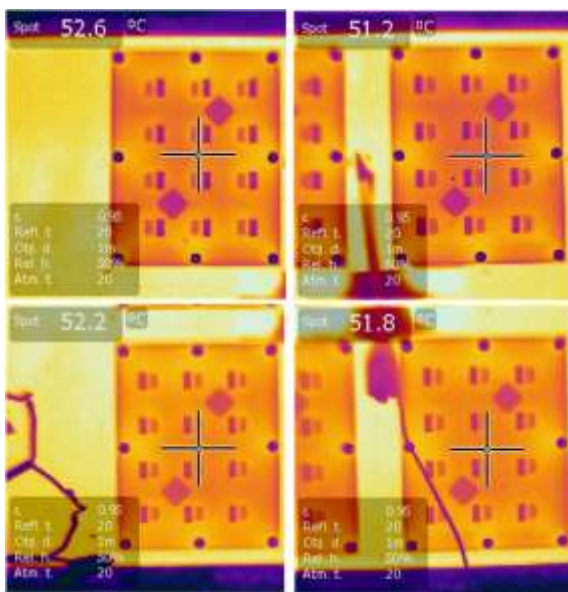

Figure 10. Thermal images of LED modules on serial connection.

As seen in the Fig. 10, temperature equality situation is verified expectedly. Module ‘A’ has the maximum temperature (52.6°C). Module ‘B’ has the minimum temperature (51.2°C). Approximately, the temperature values are the same on serial condition.

In the section, up here, the effects of connection type on electrical, thermal and optical properties were examined. Finally, the time-varying of heatsink temperature is given in Fig. 11.

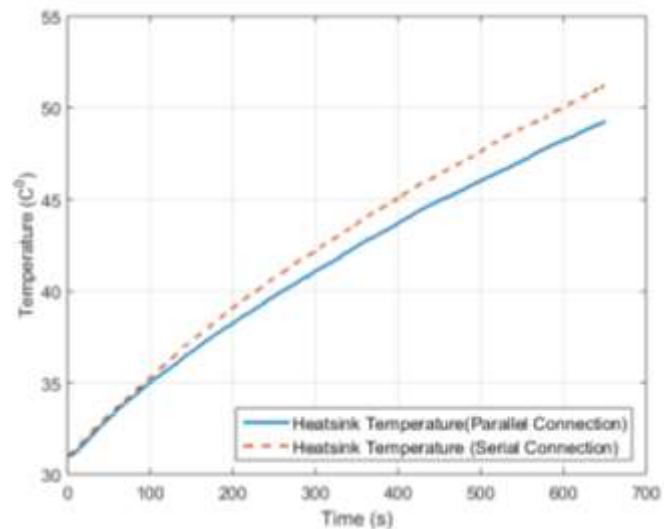

Figure 11. Heatsink temperature graphic on both condition.

As can be seen on Fig 11, temperature increases rapidly on serial condition. Same power value is used for serial and parallel connection of the LED driver output. While on serial condition $I_{ort}=I=1.03A$, on parallel condition $I_{ort}=(0.90+1.02+0.94+1.07)/4=0.9825A$. This shows that serial connection average current is higher than parallel connection average current. Luminaires with serial connection got warmer due to temperature change depends on current.

iv. Conclusion

In this study, LED module connection type effect on luminaire performance is examined. For this purpose LED driver and a luminaire are analyzed. On the next step, serial and parallel connected modules are tested under the same test condition.

Each LED module is operated at different currents in parallel connection. In theory, the LED chip which has same electrical and optical properties is expected to work in the same currents. However, lines current are not the same due to differences of LED chip resistance. Therefore unbalance of current sharing prevents homogeneous thermal radiation.

Four modules in a series line were operated with the same currents. In this case, each LED chip is operated with the nominal currents and temperatures are approximately equal for all modules.

Luminous flux (lm) of the serial connection is higher than the parallel connection, in regard to lighting performance of LED luminaire. As a result of this luminous efficacy (lm/W) is greater 11.3% than that of parallel criteria. This ratio is significant value in terms of energy efficiency.

On parallel condition, differences of LED chip resistance have a negative effect on both thermal and lighting performance. This fact can be seen from the experimental results. While thermal and optical performance is better in serial connection, reliability performance is better on the parallel connection.

Acknowledgment

The work has been supported under the grant number 2014-04-02-DOP02 by Scientific Research Project Coordination (BAPK) of Yildiz Technical University.

References

- [1] H. Valipour, G. Rezazadeh, M. R. Zolghadri, and N. Noroozi, "Electrolytic capacitor-less AC-DC LED driver with constant output current and PFC," in *The 6th Power Electronics, Drive Systems & Technologies Conference (PEDSTC2015)*, 2015, pp. 107–112.
- [2] H.-M. Huang, S.-H. Twu, S.-J. Cheng, and H.-J. Chiu, "A Single-Stage SEPIC PFC Converter for Multiple Lighting LED Lamps," in *4th IEEE International Symposium on Electronic Design, Test and Applications (delta 2008)*, 2008, pp. 15–19.
- [3] G. Sauerlander, D. Hente, H. Radermacher, E. Waffenschmidt, and J. Jacobs, "Driver Electronics for LEDs," in *Conference Record of the 2006 IEEE Industry Applications Conference Forty-First IAS Annual Meeting*, 2006, vol. 5, pp. 2621–2626.
- [4] C. H. Chen, W. L. Tsai, and M. Y. Tsai, "Thermal resistance and reliability of low-cost high-power LED packages under WHTOL test," in *2008 International Conference on Electronic Materials and Packaging*, 2008, pp. 271–276.
- [5] S.-L. Kuo, C.-K. Liu, M.-J. Dai, C.-K. Yu, H.-C. Chien, and C.-Y. Hsu, "Characteristics of Thermal Resistance for High Power LEDs," in *2008 10th Electronics Packaging Technology Conference*, 2008, pp. 149–154.
- [6] S. M. Baddela and D. S. Zinger, "Parallel connected LEDs operated at high frequency to improve current sharing," in *Conference Record of the 2004 IEEE Industry Applications Conference, 2004. 39th IAS Annual Meeting.*, 2004, vol. 3, pp. 1677–1681.
- [7] H. van der Broeck, G. Sauerlander, and M. Wendt, "Power driver topologies and control schemes for LEDs," in *APEC 07 - Twenty-Second Annual IEEE Applied Power Electronics Conference and Exposition*, 2007, pp. 1319–1325.
- [8] K. H. Loo, Y. M. Lai, and C. K. Tse, "Bilevel Current Driving Technique for LEDs," *IEEE Trans. Power Electron.*, vol. 24, no. 12, pp. 2920–2932, Dec. 2009.
- [9] M. M. Jovanovic, "LED Driver With Self-Adaptive Drive Voltage," *IEEE Trans. Power Electron.*, vol. 23, no. 6, pp. 3116–3125, Nov. 2008.
- [10] H. Akca, Y. Yasa, R. Ayaz, A. Durusu, A. Ajder, I. Nakir, and M. Tanrioven, "Thermal management of power LED system," in *2014 International Conference on Renewable Energy Research and Application (ICRERA)*, 2014, pp. 760–764.
- [11] B. Wu, X. Luo, and S. Liu, "Effect mechanism of moisture diffusion on LED reliability," in *3rd Electronics System Integration Technology Conference ESTC*, 2010, pp. 1–5.
- [12] Sanghyun Cha, Deukhee Park, Yuenjoong Lee, Changseok Lee, Joongho Choi, Jaeshin Lee, and Hyobum Lee, "AC/DC converter free LED driver for lightings," in *2012 IEEE International Conference on Consumer Electronics (ICCE)*, 2012, pp. 706–708.



Hakan Akca received the M.Sc. degree in Electrical Engineering from Yildiz Technical University, Turkey, in 2011. Now, he is currently working toward the Ph.D. in same department. His research interests include power converters, renewable energy and lighting.



Huseyin Akdemir received the B.Sc. degree in Electrical Engineering from Yildiz Technical University, Turkey, in 2014. Now, he is currently working toward the M.Sc. in same department. His research interests include renewable energy and motor control.



Ramazan Ayaz received the M.Sc. degree in Electrical Engineering from Yildiz Technical University, Turkey, in 2012. Now, he is currently working toward the Ph.D. in same department. His research interests include renewable energy and lighting.



Ali Ajder received the M.Sc. degree in Electrical Engineering from Yildiz Technical University, Turkey, in 2011. Now, he is currently working toward the Ph.D. in same department. His research interests include energy economy, renewable energy and lighting.



Ismail Nakir received the PhD. degree in Electrical Engineering from Yildiz Technical University, Turkey, in 2012. Now, he is with the Electrical Engineering Department of Yildiz Technical University, Turkey. His research areas include PV System, Maximum Power Point Trackers.



Mugdesem Tanrioven received the PhD. degree in electrical engineering from Yildiz Technical University, Turkey, in 2000. Now, he is with the Electrical Engineering Department of Yildiz Technical University, Turkey. His research areas include renewable energy, power system reliability.