

Simulation of Synchronous Condenser with PSCAD and optimization it with Chaos and Frog-Leaping algorithms

Saeid jalilzadeh

Abstract—One of the power system problem is reducing the quality due to using semiconductor devices, that should be compensate. With regarding to compensation, different compensator exist, that one of is passive filter(LCL).One of aspects of power quality is voltage or current harmonic distortion, that THD(Total Harmonic Distortion) was used for obtaining it. Obtaining of optimized parameters of filter (L,C) is more effective on reducing the THD. In this paper Frog-Leaping and Chaos optimization algorithms on obtaining of L and C and reducing of THD were used simultaneity.

Keywords—frog,chaos,compensation,optimization,passive filter

I. Introduction

One of symptoms increased power quality is decreasing in THD[6]. Active and passive filters have important role in improving current and voltage frame in power system[7]. In optimization algorithms, speed and accuracy is very important[1]. Quantity of THD depend on load version and location of load[6]. It could be gain idealized compensation seldom, but this is ratio, and depend on aim's compensation[3]. In approaching to ideal quality in power system obtaining of compensator parameters is most important part in designing[4]. With increasing use of power electronic equipment and nonlinear loads, the level of voltage harmonic distortion in distribution networks are significantly increasing. As harmonics propagate through the system, they result in increased losses and possible equipment loss-of-life. Also Over currents or over voltages resulting from resonances can damage equipment. Additionally, harmonics can interfere with control, communication, and protective equipment. With this reasons different research institutes have studied about the proper limitation of harmonic disturbance levels and released different standards. Among the several methods used to reduce these harmonic disturbances, the more employed are the tuned passive filters due to their simplicity and economical cost[5]. Proliferation of power electronic loads in the electrical distribution system has led important issues about harmonic distortion and harmonic mitigation methods. Shunt passive filters, which consist of tuned inductor and capacitor, have been used to improve power factor and suppress harmonics for many years. This kind of filter is economic but there have been many problems about harmonic amplification caused by passive filters and system impedance as to discourage their applications. Harmonic sources can be classified into harmonic current source and harmonic voltage source. Harmonic current characteristics are less dependent on AC system conditions, this type of harmonic load behaves like a current source

If the harmonic current injected into the supply system is not only determined by the loading condition but is also a function of the supply system condition, then the load behaves like a voltage source[6].

Shunt passive filters have been widely used because of their low cost and low loss. However, the performances of the passive filters are very sensitive to the power system impedance and series or parallel resonance with the power system impedance may occur. The resonance will result in the amplification of harmonic current and harmonic voltage, and it may damage the passive power filters and neighboring power equipment[7].

II. PARALLEL OPERATION OF PASSIVE POWER FILTER

A. compensation

With increasing in compensation of power, reactive power compensation, eliminating the harmonics and regulating the voltage for increasing the system efficiency, were important. However electrical power produced and distributed should be sinusoid and has a constant frequency and amplitude. Voltage and current have non sinusoid frame because nonlinear elements (generators, motors, transformers ,different power electronic devices) exist .The aims of compensation are:

- 1) Compensation the reactive power
- 2) Voltage regulating
- 3) Balancing current
- 4) Eliminating the harmonics

Eliminating the harmonic consist of eliminating the load current harmonic and voltage source. Load current harmonic cause production harmonic voltages at line, that it forced distortion consumed voltage neighborhood loads. Also eliminating the effect of voltage harmonic on load cause decreasing losses in motors, eliminating sonic noises and prevention the vibration[3].

B. Passive Power Filter

For the most nonlinear loads, the main harmonics are 3rd, 5th, 7th, 11th and 13th. The tuned frequency of the passive power filters is suggested to set at the lowest main order harmonic. The 3rd passive filter should be selected if large 3rd harmonic current exists in the load, and 5th passive filter selected if large 5th harmonic current exists. If both 3rd and 5th harmonics exists, 3rd and 5th passive filter may be selected simultaneously. However, the tuned frequency of the passive power filter large than 5th is not recommended because good harmonic compensation can be obtained with the parallel operation of proposed lower-order tuned frequency passive filter[7]. In general, two version filter are exist:

- 1) Active Filter
- 2) Passive Filter

Passive filter has resistor, inductor, capacitor, that usually used as LCL, and also has a damping resistor(Rd). Quantity of filter parameters play important role in compensation, that inductor and capacitor don't go saturation or resonance, and could sinusoid the frames of voltage and current. Passive filter has following benefits and defects. Benefits:

- 1) Reliable operation
- 2) Easy design process
- 3) As reactive power compensator
- 4) Low cost

Defects:

- 1) High quantity elements
- 2) High volume
- 3) Depending on impedance of system
- 4) Regulated for specific load
- 5) Series or parallel resonance
- 6) Affected by aging

Parameters were obtained via experiment already. In this paper, Frog and Chaos algorithms was used for obtaining the optimum quantity of L and C and reducing THD[2].

III. Shuffled frog-leaping algorithm

The SFLA is a meta-heuristic optimization method that mimics the memetic evolution of a group of frogs when seeking for the location that has the maximum amount of available food. The algorithm contains elements of local search and global information exchange. The SFLA involves a population of possible solutions defined by a set of virtual frogs that is partitioned into subsets referred to as memeplexes. Within each memeplex, the individual frog holds ideas that can be influenced by the ideas of other frogs, and the ideas can evolve through a process of memetic evolution. The Frog-Leaping performs simultaneously an independent local search in each memeplex using a particle swarm optimization like method. To ensure global exploration, after a defined number of memeplex evolution steps (i.e. local search iterations), the virtual frogs are shuffled and reorganized into new memeplexes in a technique similar to that used in the shuffled complex evolution algorithm. In addition, to provide the opportunity for random generation of improved information, random virtual frogs are generated and substituted in the population if the local search cannot find better solutions. The local searches and the shuffling processes continue until defined convergence criteria are satisfied. The flowchart of the SFLA is illustrated in Fig. 1. The Frog-Leaping is described in details as follows: First, an initial population of N frogs $P=\{X_1, X_2, \dots, X_N\}$ is created randomly. For S -dimensional problems (S variables), the position of a frog i th in the search space is represented as X_i . A fitness function is defined to evaluate the frog's position. For minimization problems, the frog's fitness can be defined as:

$$fitness = 1/[f(X) + C] \quad (1)$$

and for maximization problem, the frog's fitness can be simply defined as:

$$fitness = f(X) + C \quad (2)$$

where $f(X)$ is the objective function to be optimized, and C is a constant chosen to ensure that fitness value is positive. Afterwards, the frogs are sorted in a descending order according to their fitness. Then, the entire population is divided into m memeplexes, each containing n frogs (i.e. $N = m \times n$), in such a way that the first frog goes to the first memeplex, the second frog goes to the second memeplex, the m th frog goes to the m th memeplex, and the $(m+1)$ th frog goes back to the first memeplex, etc. Let M_k is the set of frogs in the k th memeplex, this dividing process can be described by the following expression:

$$M_k = \{X_{k+m(l-1)} \mid 1 \leq l \leq n\}, (1 \leq k \leq m) \quad (3)$$

Within each memeplex, the frogs with the best and the worst fitness are identified as X_b and X_w , respectively. Also, the frog with the global best fitness is identified as X_g . During memeplex evolution, the worst frog X_w leaps toward the best frog X_b . According to the original frog leaping rule, the position of the worst frog is updated as follows:

$$D = r \cdot (X_b - X_w), \quad (4)$$

$$X_w(new) = X_w + D, (||D|| < D_{max}), \quad (5)$$

where r is a random number between 0 and 1; and D_{max} is the maximum allowed change of frog's position in one jump. Fig.2 demonstrates the original Frog-Leaping rule. If this leaping produces a better solution, it replaces the worst frog. Otherwise, the calculations in (4) and (5) are repeated but respect to the global best frog (i.e. X_g replaces X_b). If improvement becomes impossible in this case, the worst frog is deleted and a new frog is randomly generated to replace it.

The calculations continue for a predefined number of memetic evolutionary steps within each memeplex, and then the whole population is mixed together in the shuffling process. The local evolution and global shuffling continue until convergence criteria are satisfied. Usually, the convergence criteria can be defined as follows:

- 1) The relative change in the fitness of the best frog within a number of consecutive shuffling iterations is less than a pre-specified tolerance;
- 2) The maximum user-specified number shuffling iterations is reached. The SFLA will stop when one of the above criteria is arrived First[8].

In problem of design of filters, achieving to minimum THD and obtaining of parameters is most objective. So in optimization, we should obtain quantity of L and C filters and achieve to minimum of THD with optimized L,C. Our objective function in this paper is equal to:

$$O.F = THD_a(\text{end}) + THD_b(\text{end}) + THD_c(\text{end}) \quad (6)$$

THD_a , THD_b and THD_c is harmonic distortion of phase voltages a, b and c respectively.

IV. CHAOS ALGORITHM

This algorithm is a new random search, that has essential different with other evolutionary algorithms. It could be defined that turbulence is a random production with a simple defined system. This algorithm doesn't entail from minimum local points with acceptance bad answers basis specific probability, but searches with basis order in turbulence motion, and could entail from turbulence motion[4]. Variable of turbulence: Process of Chaos optimization algorithm is basis of production random numbers basis chaos theory. For a function with n variables, per member was produced according one turbulence variable(X). On the other hand, turbulence variables(n) should be used. Variables of turbulence were produced with Logistic map function:

$$\gamma_i(k) = \mu \gamma_i(k-1) (1 - \mu \gamma_i(k-1)) \quad (7)$$

In this formula, μ is a control parameter and equal to 4, and also $0 < \gamma_i(0) < 1$. Unlike simplicity of this formula, wide variety will seen in output answers behaviorally, that didn't repeat any value from $\gamma_i(k)$. This problem will result from

sensibility of system from initial condition, that come from turbulence basis property. The values shouldn't be select from (0, 0.25, 0.5, 0.75,1) as initial values. This value is as constant points, and with select this values as initial values won't be produce new values. After production of turbulence variant, X_i could be produce from following:

$$X_i(k) = X_i^* + \alpha_i(2\gamma_i(k) - 1) \quad (8)$$

X_i^* is a optimization variant according to final optimized point that obtained. α_i is neighborhood radius[9].

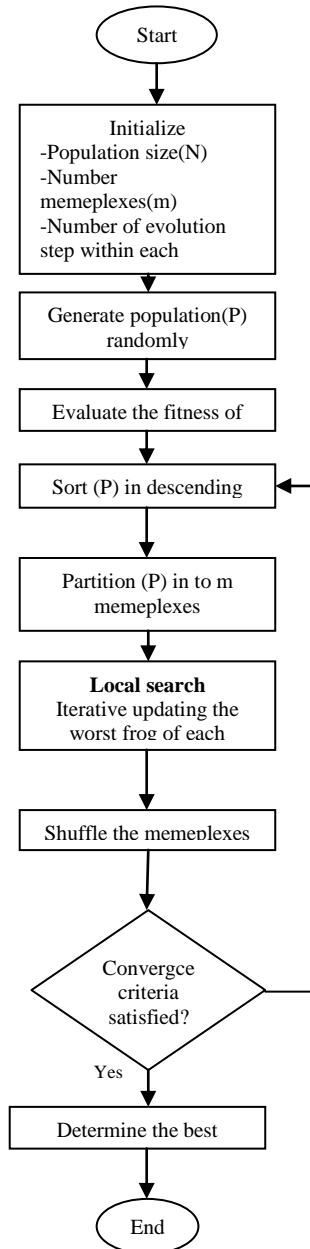

Fig. 1. Flowchart of SFLA

V.case study

Configuration of system was presented in Table I.Also $L_a=1.4H$ and $L_b=2.8H$.The iteration for both algorithm is 100.Circuit of system without compensation is shown in Fig.2.Schematic of System under study was shown in Fig.2 and PSCAD software was used for simulation.

Table I-General information

S	150MVA	230KV	$R_s=5\Omega$	$R_p=1\Omega$	$L_p=0.1H$
B	$T_p=1.5s$	open			
T	160MVA	Δ/Y	3 Φ	$X_l=0.1p.u$	13.7kv/230kv
C	V =7.91KV	I=7.08KA	$T_m=0$	f=60Hz	Q=100MVA

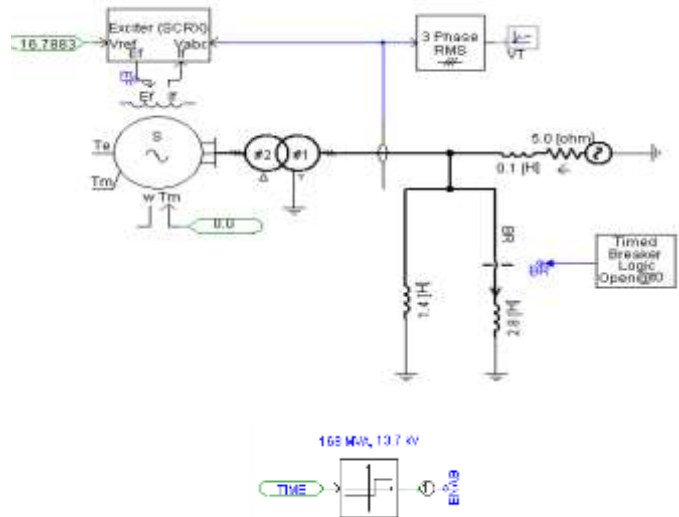

Figure.2.System Under Study

VI. result (before compensation)

It could be spot three functions for P and Q. Gain of transfer function (G) equal to 168.Time assumed 0.3 second. In per stage pole or zero or both was changed. Also before using compensator THD equal 8%.In Table 1,S is synchronous generator, B is breaker, T is transformer and C is condenser.

A. one pole

In this section diagrams of active and reactive power and excited voltage of Synchronous Condenser and terminal voltage of Synchronous Condenser were shown in Fig.3.

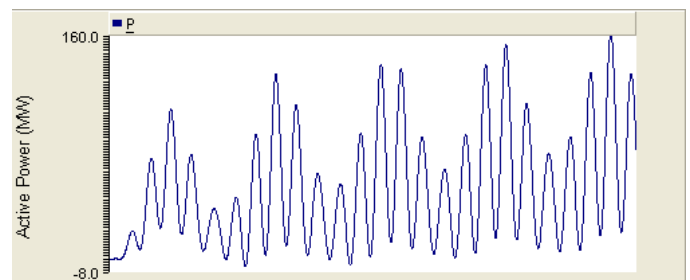
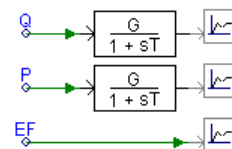

(a)Diagram of line active power

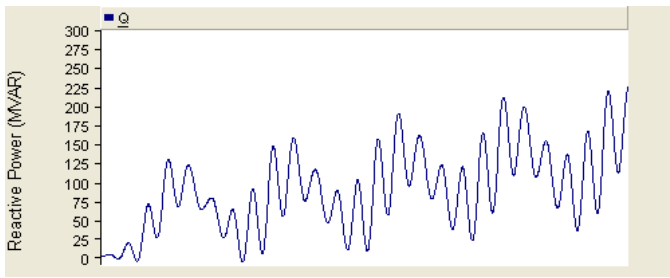

(b) Diagram of line reactive power

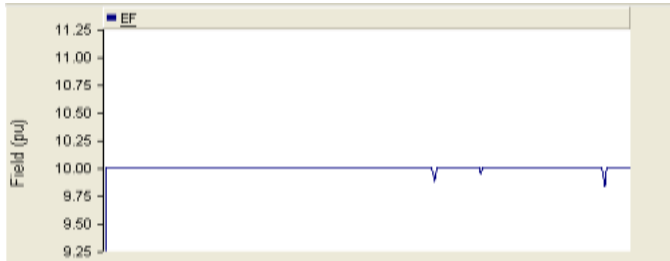

(c) Excited voltage of Synchronous Condenser



(d) Terminal voltage of Synchronous Condenser

Figure.3.Diagrams of A status

B. Adding zero(z=0)

In this section, one zero is added.diagrams of active and reactive power were shown in Figure.4.

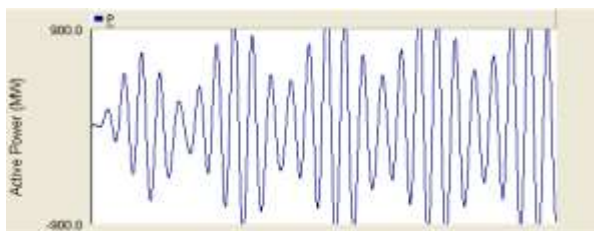
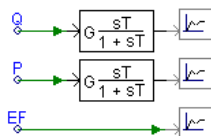

(a) Diagram of line active power

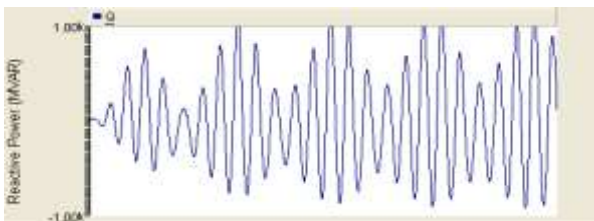

(b) Diagram of line reactive power

Figure.4.Diagrams of B status

C. adding zero and pole

In this status T1=0.05s;T2=0.005s and position of pole and zero were changed.

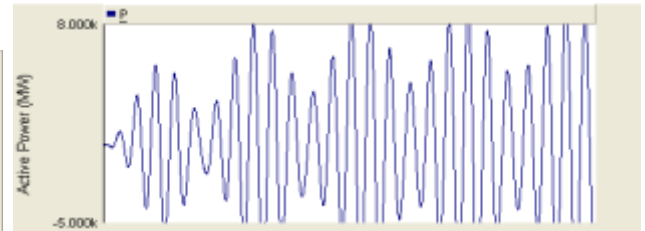
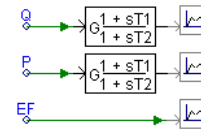

(a) Diagram of line active power

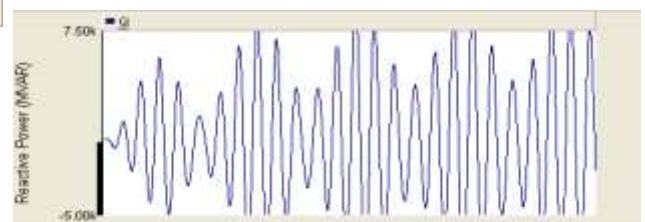

(b) Diagram of line reactive power

Figure.5.Diagrams of C status

VII. Test result(after compensation)

In this stage, passive filter (LCL) was used, that quantity of parameters is presented in Fig.6.After compensation, THD will be 3%.Quantity of inductors is equal with other. It should be mentioned that damping resistor wasn't used. With regarding to frames, in transient status, power has swings, that depends on transfer function. Other aim should be high speed passage from this swings that could affect on operation of system.L1=L2=0.0031[H] and C=0.0711[uF].In Figure.7, diagrams of excited voltage of Synchronous Condenser and terminal voltage of Synchronous Condenser were shown.For optimization of L and C in Passive Filter with Frog-Leaping and Chaos algorithms, transfer function has one pole.

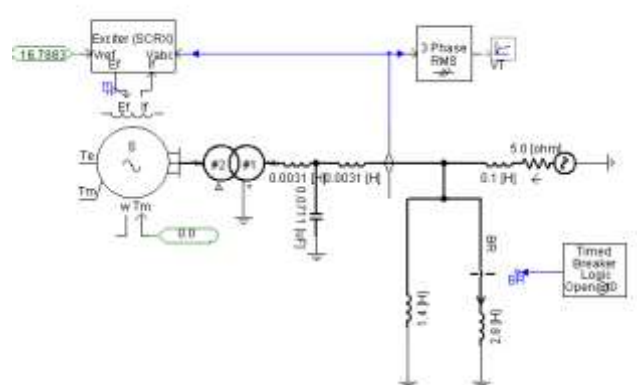
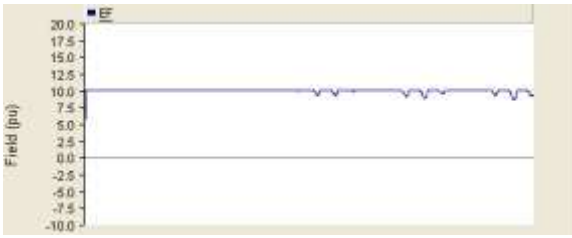
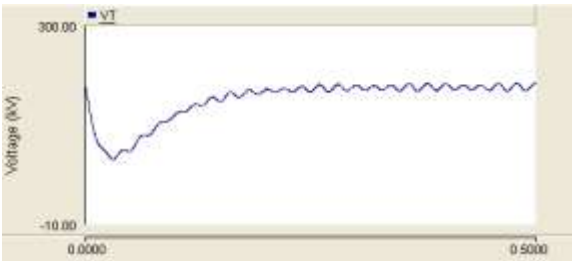

Figure.6. System Under Study(after compensation)



(a) Diagram of excited voltage of Synchronous Condenser



(b) Diagram of terminal voltage of Synchronous Condenser

Figure.7. Diagrams after compensation

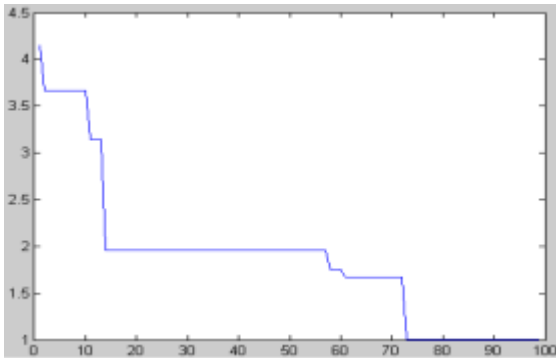

(a) Frog-Leaping

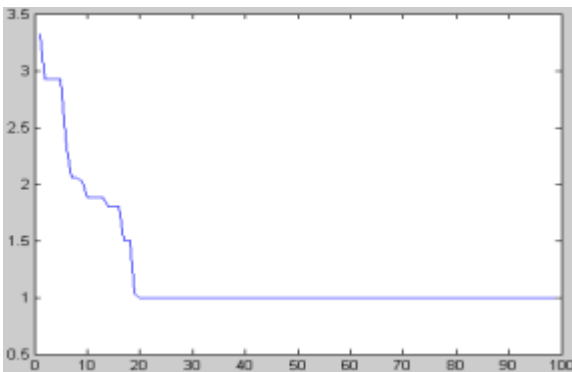

(b) Chaos

Figure.8. Results of algorithm's convergence

Convergence diagram of Frog-Leaping and Chaos algorithm were shown in Fig.8. Chaos algorithm has a higher speed in convergence than Frog-Leaping algorithm, but accuracy of Frog-Leaping algorithm is more than Chaos algorithm.

VIII.conclusion

LCL filter has a high cost and high efficiency in compensation. Obtaining L and C is hard experimentally. Therefore Chaos and Frog-Leaping algorithms were used that Chaos algorithm has a better operation and higher speed

than Frog-Leaping algorithm, but accuracy of Frog-Leaping is more than Chaos. Via Chaos and Frog-Leaping optimum parameters of passive filter were obtained and THD was changed from 8% to 3%.

References

- [1] D. E. Goldberg, Genetic Algorithms in Search, Optimization and Machine Learning, Addison Wesley Publishing Company, Ind USA, January 1989.
- [2] M. Liserre, F. Blaabjerg, S. Hansen, Design and control of an LCL-filter based three-phase active rectifiers, IEEE Transactions on Industry Applications 41(2005) 1281–1291.
- [3] Y. Lang, D. Xu, H.S. Handranamrei, H. Ma, A novel design method of LCL type utility interface for three-phase voltage source rectifier, in: Proceedings of the IEEE PESC'05, vol. 1, 2005, pp. 313–317.
- [4] E. Elbeltagi, T. Hegazy, and D. Grierson, Comparison among five evolutionary-based optimization algorithms, Advanced Engineering Informatics, vol. 19, no. 1, pp.43–53, 2005.
- [5] M. Ghiasi, V. Rashtchi, and S.H. Hoseini Optimum location and sizing of passive filters in distribution networks using genetic algorithm, In: Proceedings of the IEEE, 2008 International Conference on Emerging Technologies.
- [6] Tain-Syh Luor, Influence of Load Characteristics on the Applications of Passive and Active Harmonic Filters, Proceedings of the IEEE, 2000.
- [7] Yonghai Xu, Xiangning Xiao, Hao Liu, Hong Wang, Parallel operation of hybrid active power filter with passive power filter or capacitors, 2005 IEEE/PES Transmission and Distribution Conference & Exhibition: Asia and Pacific Dalian, China.
- [8] Thai-Hoang Huynh, A Modified Shuffled Frog Leaping Algorithm for Optimal Tuning of Multivariable PID Controllers, Proceedings of the IEEE, 2008.
- [9] V. Rashtchi, H.fotoh abadi, E.rahimpour, Identity of parameters RLCM of transformer with use of Chaos theory, International power system conference 22nd.PSC(2007).



Saeid Jalizadeh was born in 1962. He received his B.Sc. and M.Sc. degree both in electrical engineering from Tabriz University in 1986 and 1989, respectively. He received Ph.D. degree in electrical engineering from Iran University of Science & Technology in 2005. Currently, he is an Associated Professor at electrical Engineering Department of Zanjan University, Zanjan, Iran. Saeid is the author of more than 70 journal and conference papers. His research interests are dynamic stability, power market, and renewable energy in power system, power system contingency analysis and power system planning.