

BetterNet: A Decision Support System for Chlorination of Water Distribution Systems

Mustafa Kemal Pektürk, Hürevren Kılıç and SELÇUK SOYUPAK

Abstract— One of the challenging problems of water supply engineers is to provide safe water at the consumers' tap. Chlorine is a widely utilized disinfectant in water distribution systems to provide such safety. Utilization of booster stations can be a remedy to keep free residual of chlorine levels within desirable limits and to satisfy acceptable low variability. In this research, a decision support system for chlorination of water distribution systems what we call BetterNet is developed. The system provides an effective tool for the decision makers and improves the quality of the WDS design process. More importantly, it reduces possible unnecessary expenditures due to wrong decisions about boosting station number, location and amount of chlorine to be used. With its tunable parameters and support to different objective functions, user can operate the system and obtain the decision support via easy-to-use graphical user interface.

Keywords— *decision support system, water distribution system chlorination, scheduling, genetic algorithms, extended period simulation.*

I. Introduction

Chlorine is a widely utilized disinfectant in water distribution systems (WDS) to provide safety. However, it is well-known fact that chlorine reacts with natural organic matter within bulk water and with pipe material and films that causes decays during its transport and distribution. This brings the problem of high variability of the free residual chlorine (FRC) levels within WDSs supplied only from a single source and with single chlorine dosing station. Even further, some consumers may get water with FRC concentrations higher than desirable maximum levels while some consumers may not have minimum levels to ensure safety against water-borne diseases. The desirable minimum level is given as 0.2 ppm at consumer's tap for treated surface waters [1]. Usually the water quality standards for water consumption do not set any limit for the maximum levels of FRC. Regulations concerning waters intended for human consumption suggest a maximum level of 0.5 ppm [2].

Mustaf Kemal Pektürk, MSc.
HAVELSAN A.Ş., 06510, Çankaya, Ankara, TURKEY

Hürevren Kılıç, PhD
Computer Engineering Department, Engineering and Architecture Faculty,
Gediz University , Menemen, Izmir, TURKEY

Selçuk Soyupak, PhD
Civil Engineering Department, Engineering Faculty,
KTO Karatay University , 42020, Konya, TURKEY

Such a level reduces the risk of trihalomethane (THM) formation. The levels as close as possible to the lower limit minimize the formation of THMs.

We know that the utilization of booster stations can be a remedy to keep FRC levels within desirable limits and also to satisfy acceptable low variability. On the other hand, before developing any boosting plan for any WDS, we need to answer the following questions: 1) How many booster stations should we install and operate? 2) Where should we locate these stations? 3) What should be the chlorine dosing for these boosters? 4) How can we keep chlorine utilization at required levels? 5) Can we reduce the chlorine levels to lower values at the exit of main sources? Clearly, these practical concerns of WDS planning and operation impose the need for a decision support system.

Location selection for optimal chlorination for disinfection purpose itself is a known problem in literature [3,4]. Booster-based optimum chlorination scheduling research considers linear or nonlinear kinetic decay with a single objective function [5,6]. An alternative study proposes a pareto-based multi-objective approach for the problem [7]. The use of GA with a single objective function for solving the problem has been proposed in [8]. Two other GA based approaches for finding optimum location and number of booster stations have been introduced in [9,10], independently.

The system developed within the scope of this research aims to be a decision support solution that answers the above questions for any WDS of concern. Different from alternative GA based approaches; it provides not only the advantage of intelligent GA search mechanism but also realistic deterministic modeling of WDS under study via its wrapped EPANET software [11]. Support of five different alternative objective functions and user configurable GA and water distribution network parameters are considerable properties of the system. The existing extended period simulation (EPS) capability of the EPANET tool grounds the BetterNet into more realistic system representation and dynamics.

In Section 2, we introduce both architecture and software implementation of the proposed solution including flexibilities provided by tunable GA and WDS domain parameters. An example use of BetterNet by a domain expert and obtained evaluation results are summarized and discussed in Section 3. The last section is the conclusions.

II. Materials and Methods

In this section, we describe the proposed solution and its implementation together with its developed and used components.

A. Proposed Solution

The BetterNet solution can be positioned as an offline decision support tool for optimum chlorination of water distribution systems. In this study, our answer for better representation is not based on a data-driven automated modeling (as in the use of neural networks [12]), but based on an expert-designed, equation-based deterministic models supported by open-source EPANET software. Simply, the proposed solution is nothing but a plug-in level search/optimization component that can elaborate on different water network optimization criteria.

In order to solve the location and dosing amount selection problem for FRC level control in WDS, we coupled a nature inspired computing solution namely Genetic Algorithms [13] with EPANET based deterministic modeling solution. Intelligent search mechanism provided by GA and realistic modeling via the adopted deterministic approach were two basic building blocks of the proposed solution. Two units execute together in the form of a wrapper depicted in Figure 1. During BetterNet execution, the GA component searches for the best dosing location and amount that tries to keep FRC levels as much as possible in acceptable ranges in terms of public health concerns. The model responses are obtained by the end of extended period simulations that are executed on the deterministic network model. The responses are considered as the fitness results for the current dosing strategy.

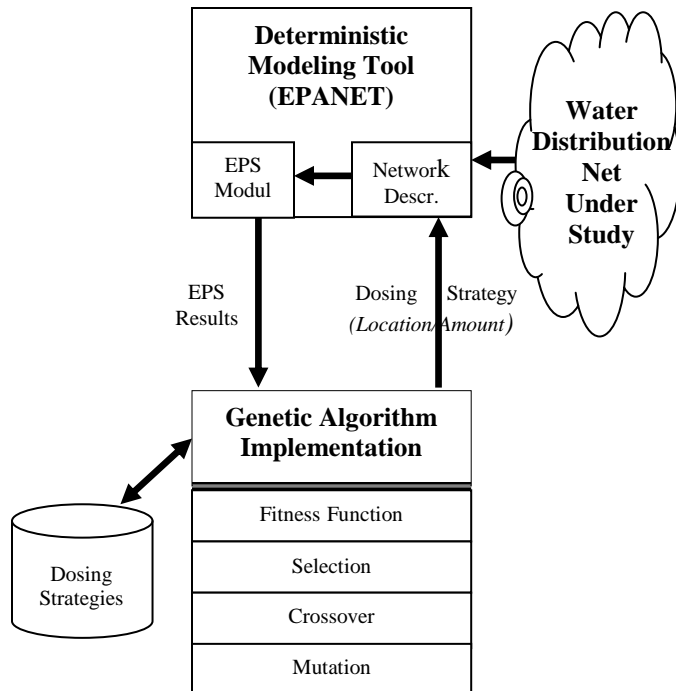
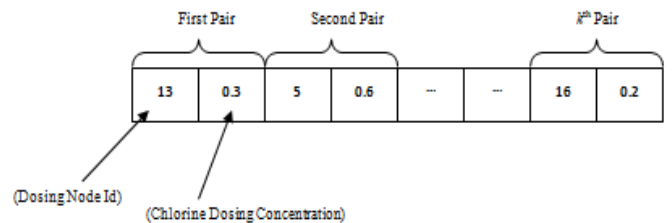

Figure 1. Architecture of the solution.

We represent the genotypes (i.e. individuals or chromosomes) as dosing strategy patterns (see Figure 2-a). Patterns correspond to candidate solutions to the problem. Each candidate solution is constituted by a vector of node-id and chlorine-dosing-concentration pairs. Suppose that we have m number of potential candidate dosing locations among which k of them will be selected. Further suppose, we have n different candidate chlorine concentration values per location that can be chosen during dosing. So, the size of the search space is:

$$Space_Size = \binom{m}{k} n^k \quad (1)$$

Search space size increases exponentially. Fitness score of an individual is related to its dosing success that achieves the objective function under study. BetterNet implements roulette wheel selection algorithm for individual selection. Crossover operator is implemented as a single point (see Figure 2-b). Search randomness (or variation) is provided by a single location or a single dosing amount mutation. All other GA parameters are user-definable and they are listed in subsection 3.2.



(a) Representation of an individual.

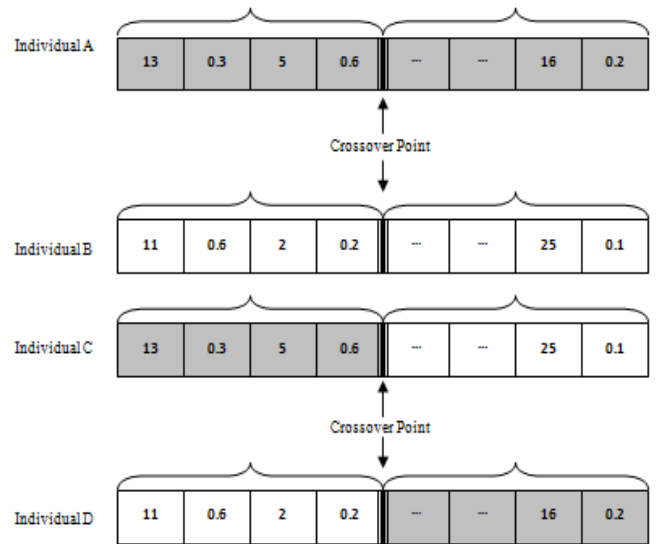

(b) Old (A and B) and new (C and D) individuals obtained after crossover operation.

Figure 2. Individual representation (a) and single-point crossed individuals (b).

B. Implementation Details

BetterNet is developed as a stand-alone application written in C/C++ programming language. The program calls EPANET Dynamic Link Library (DLL) functions using which developers can customize EPANET's computational engine for their needs. The functions can be embedded into 32-bit Windows applications for any language that can call them within the DLL. The program evaluates models by performing extended period simulation (EPS) of hydraulic and water quality behavior within networks. BetterNet also uses available Interop.dll to give some graphical view to user. The software is implemented as a collection of five components (see Figure 3). Graphical user interface provides user an interface to enter model parameter, GA parameter and the model itself to the system. It also shows a screen for watching progress status of the program. Briefly, this component is a bridge between user and GA component. GA component includes genetic operators: Selection, crossover, mutation, fitness functions, etc. It calls EPANET DLL to computing fitness values of individuals within network model. Firstly, it solves hydraulic behavior of water distribution systems, and then it analyzes water quality behavior of the network with each individual one by one. EPANET performs EPS for hydraulic and water qualities of pressurized pipe networks. A network may be built up from pipes, nodes (pipe junctions), valves, pumps and storage tanks/reservoirs. Using EPANET one can track water flow in each pipe, nodal pressures, water height in each tank, and chemical species concentrations throughout the network in multi-time period simulations. Besides from chemical species, water age and source tracing can be simulated, also.

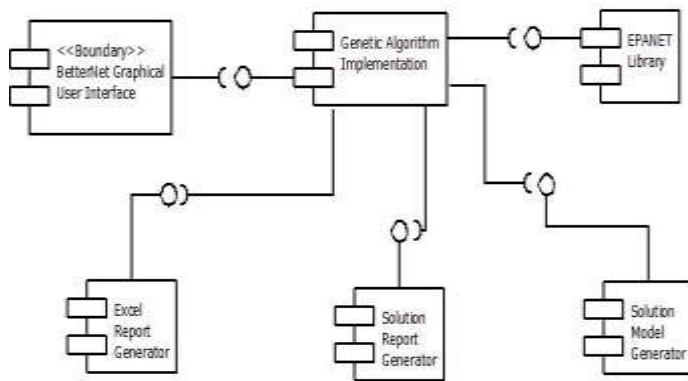

Figure 3. Component based description of the BetterNet solution.

BetterNet can generate a solution report within solution report generator component. This report includes model path, solution date, all parameters and fitness values of all fitness functions for each generation and the solution. The program gives a table for following each generation and corresponding fitness value via generation tracking component. It provides a chart with generation number and fitness value for understanding solution graphically. Finally, after the program finds the solution, solution model generator component

prepares a model with booster stations which are determined by GA component. User can open this model within EPANET, directly.

BetterNet supports two types of tunable system parameters: GA parameters and WDS parameters. User can execute different water distribution network chlorination candidate applications on the model under study by trying alternative scenarios, automatically. All system parameters can be saved for later experimentation and can be reloaded from a file. User can observe/report/pause/continue or stop the search process at any time during execution. The following two subsections introduce capabilities of the BetterNet provided via the tunable system parameters.

There are eight GA parameters/switches that can be set by the user (see Figure 4). Population Size (PS) defines the current scope of the search process. Higher PS value increases the probability of better quality individuals to be encountered at the cost of overall processing time. Initial Population (IP) can be set either “randomly” via program or by entering them “manually”. The advantage of manual entry is to allow good candidate solutions decided by the domain expert to appear in the initial search set. The crossover is the basic mechanism for new individuals to be constructed however the risk is to ignore nearby better solutions residing at the search space. Therefore, BetterNet provides its user a control over the Crossover Probability (CP). Mutation on the other hand is nothing but to permit random modifications over an individual’s description that may lead to possible backward movements in the search space. So, like CP, user can define the Mutation Probability (MP) that facilitates the control over amount of individual’s randomization. Higher MP values turn the so claimed intelligent search process into a random walk over the landscape.



Figure 4. User screen for tunable genetic algorithm parameters.

Keeping relatively good solutions at hand (or simply in memory) may facilitate the search process and may provide a kind of momentum throughout the search process. The control over its amount is provided by Elitism Percentage (EP) parameter indicating the ratio of the best solutions coming from the previous generation and kept in the current generation. Execution of BetterNet can be visualized and stopped at any time by its user (see Figure 5). The Stopping

Criterion (SC) can either be a Fixed Number of Generations (FNG) set by the user or a small constant threshold value Epsilon (E) showing the amount of improvement in the objective function value. The search process continues as long as the change between current and the previous objective function value is greater than a desirable satisfactory minimum value pre-set by the user.

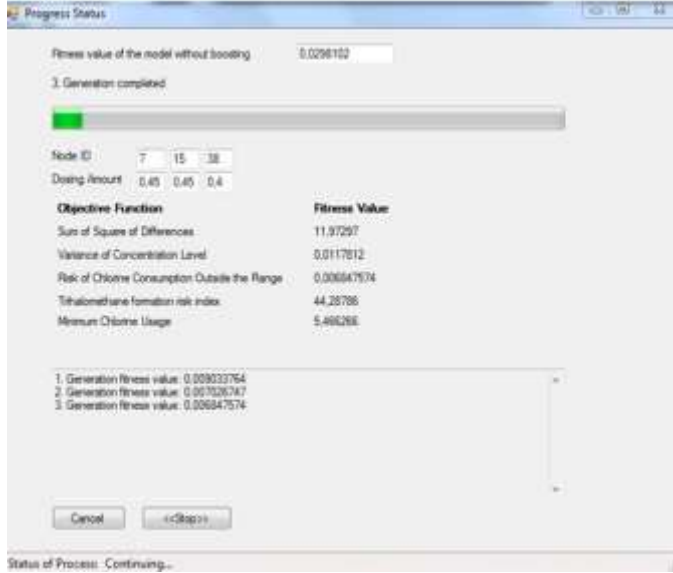

Figure 5. User screen to follow up search process progress.

There are twelve WDS parameters/switches that can be set by the user (see Figure 6). Different from GA parameters, WDS parameters provide domain specific preferences to be specified. User can set any one of five different domain specific objective (or fitness) functions decided by domain expert. Their calculations are mainly based on the amount of feedback concentrations taken from the junction points (i.e. nodes) that are obtained by the end of EPANET software extended period simulation. The upper and lower threshold values for concentrations are allowed to change between 0.20 (c_{min}) and 0.50 (c_{max}) ppm. Note that current version of the BetterNet does not support multi-objective decision making. However, in addition to a selected objective function, user can observe changes of other non-selected objective function values attained throughout the search process. Below, we list the supported fitness/objective functions.

For all objective function applications the algorithm works in such a way that we try to keep ($c_{min} \leq c \leq c_{max}$) for any node and for any time. The objective functions 1 and 2 are alternative objective functions to reduce variability of FRC levels within any WDS.

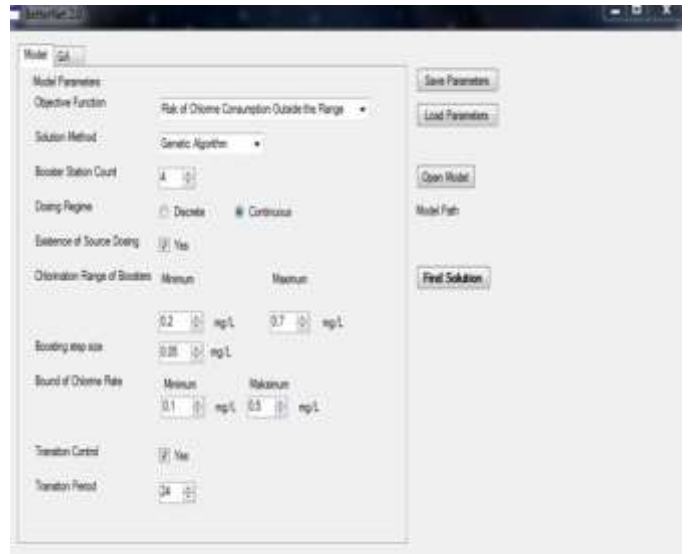

Figure 6. User screen for tunable water distribution system model parameters.

1. Centralization of FRC levels:

$$Min(SSD) = \sum_{i=1}^m \sum_{j=1}^T |c(i,j) - c_{median}|^2 \quad (2)$$

where

$SSD(m, T)$: The sum of square of differences between FRC concentration levels and desirable average FRC concentration value (median of maximum and minimum allowable concentrations) throughout the EPS process,

m : Total number of nodes,

T : EPS duration excluding the starting transition period,

i, j : Indices for the nodes and time steps,

$c(i,j)$: Calculated FRC concentration level at i^{th} node for the j^{th} time step,

$$c_{median} = \frac{c_{max} - c_{min}}{2}$$

c_{min} : Minimum allowable FRC concentration level within WDS,

c_{max} : Maximum allowable FRC concentration level within WDS,

$$\text{Allowable range: } (c_{min} \leq c_{i,j} \leq c_{max})$$

2. Minimization of variance of FRC levels within WDS:

$$Min \sigma^2 = \frac{\sum_{j=1}^T \sum_{i=1}^K (c_{i,j} - \bar{c})^2}{N - 1} \quad (3)$$

where

$c_{i,j}$: FRC concentration level of node i in time j ,

σ^2 : Variance of concentrations,

i : The index of a node,

K : Total number of nodes,

T : EPS duration excluding the starting transition period,

\bar{c} : Average of the calculated concentrations,

N : $T * K$

3. Minimization of risk of occurrence probability of FRC concentration values outside of the allowable range:

The purpose of this objective function is to minimize the risk level of consumption of water with FRC concentrations outside the allowable range. The minimum and maximum risk levels that can be calculated are 0 and 1 respectively.

$$\text{Min}(R = \text{risk of consumption of water FRC levels outside of allowable range} = \left(1 - \frac{\sum_{j=1}^T \sum_{i=1}^{KP} Q_{i,j} c_{i,j}}{\sum_{j=1}^T \sum_{i=1}^{NN} Q_{i,j} c_{i,j}}\right) \quad (4)$$

where

$c_{i,j}$: Chlorine concentration level of node i in time j ,

$Q_{i,j}$: The amount of flow demand at node i in time j ,

KP : Total number of nodes having concentration levels within allowable range where $(c_{min} \leq c_{i,j} \leq c_{max})$

NN : Total number of nodes,

T : EPS duration excluding the starting transition period,

4. Minimization of trihalomethane formation risk index:

This objective function has been selected to minimize **system specific** trihalomethane formation risk index (TFRI) by keeping FRC level as low as possible. There is no universal limit for upper TFRI levels. The values might vary and the **relative magnitudes** should be compared under different proposed solutions for the same WDS.

$$\text{Min}(SSD = \text{TFRI} = \sum_{i=1}^{NN} \sum_{j=1}^T |c(i,j) - c_{min}|^2) \quad (5)$$

where

SSD : The sum of square of differences between FRC concentration levels and permitted lowest concentration values throughout the EPS process,

NN : Total number of nodes,

T : EPS duration excluding the starting transition period,

i, j : Indices for the nodes and time steps,

$c(i, j)$: FRC concentration level at node i in time step j ,

5. Minimization of total FRC that reaches to consumers:

This objective function is to minimize total FRC that reaches to consumers while trying to keep keeping FRC levels within allowable limits $(c_{min} \leq c_{i,j} \leq c_{max})$

$$\text{Min}(\text{Total FRC that reaches to consumers} = \sum_{i=1}^{NN} \sum_{j=1}^T Q_{i,j} c_{i,j}) \quad (6)$$

where

NN : Total number of nodes,

T : EPS duration excluding the starting transition period,

i, j : Indices for the nodes and time steps,

$c_{i,j}$: Measured chlorine concentration level at node i in time step j ,

$Q_{i,j}$: The amount of water demand at node i in time j .

It must be noted here that some of these objectives might be conflicting with others. This is the reason why BetterNet was not intended to have multi-objective optimization capabilities. However, the software can be activated for each objective function independently while the magnitudes of the other objective function can be monitored in parallel quantitatively under each optimization selection. A simultaneous evaluation of the results by experts is a must after each application.

For smaller m , n and k values application of GA may become obsolete. In such cases, simple exhaustive search of the search space guarantees to find an optimal solution in acceptable execution times. Therefore, in BetterNet user can set Method of Solution (MS) variable either to GA Search or Exhaustive Search.

Chlorination done at common reservoir (or source) site is mostly a natural choice for effective and efficient WDS chlorination. However, existence/nonexistence of “source dosing” throughout the search process is provided as a choice to the user (Existence of Source Dosing - ESD variable). In addition to the source, the number of other dosing locations can be set via variable Number of Additional Dosing Location (NADL). For an acceptable time performance, the upper limit for NADL is supposed to be 35 locations.

Dosing Regime (DR) can either be applied continuous or discrete time steps. The Range of Additional Chlorine Concentration (RACC) amount can be set by user. The unit of concentration is mg/L. The number of alternative dosing amount depends on the Step Size (SS) variable decided by user. The target range of FRC in nodes can be determined by entering related minimum and maximum values. As an initial stage of EPS one can specify a transition period (in hours) by the end of which the network is supposed to enter a cyclic time series and becomes stable. The FRC results obtained during transition period should be ignored in objective function calculation.

III. Results and Discussions

In order to evaluate the BetterNet software, we developed independent optimization studies based on supported objective functions. A hypothetical network (Figure 7) has been designed to exploit the optimization capabilities of BetterNet.

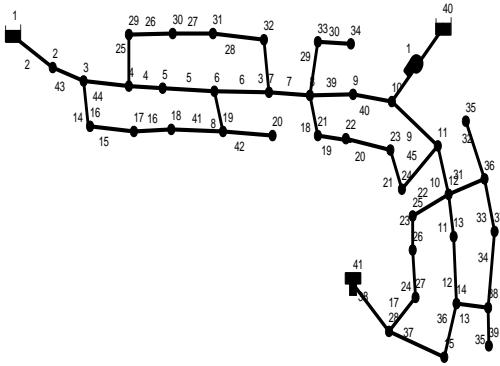

Figure 7. The designed synthetic network.

Table 1 summarizes the major physical characteristics of the network under study. The designed network is considerably complex with 2 supply reservoirs with source chlorination and there is a pump in the system. There is a balancing reservoir. The base demand is almost sufficient for an equivalent 100,000 population assuming 200 l/cap/day consumption. Total of pipe lengths is 43.2 km.

TABLE I. MAJOR PHYSICAL CHARACTERISTICS OF THE TEST NETWORK

# of Nodes	# of Src. Rsvr.	# of Tanks	# of Pumps	# of Pipes	# of Pipe Len. (km)	Total Base Nodal Dmnd. (cmh)	Diamtr Range (mm)
39	2	1	1	45	43.2	754	200-400

The assumed diurnal demand pattern is periodic with 24 hour intervals and summarized by Figure 8. The hydraulic and decay kinetics are assumed to be pre-calibrated in order to simplify the presentation. The supply reservoirs feed chlorine with a constant concentration level of 0.5 ppm for the first four objective functions. The chlorine dosing levels at reservoirs are the optimization outputs for the fifth objective function.

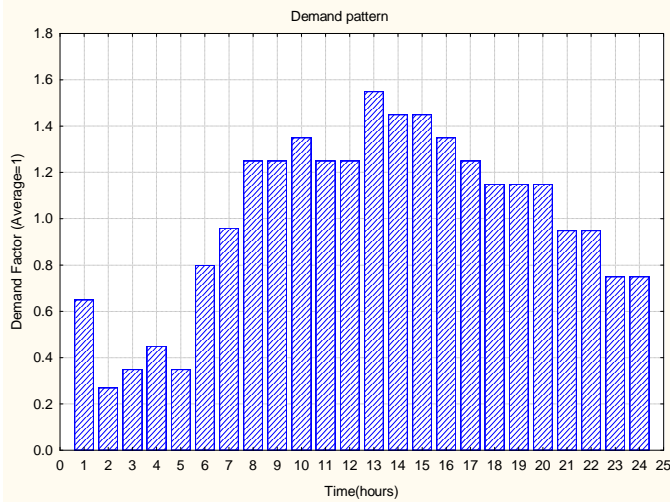

Figure 8. Demand pattern.

In order to see the capabilities and limitations of the developed software, 4 separate categories of optimization study, have been performed. Each study category corresponds to an individual objective function. Chlorine boosting range was set to 0.2-0.5 ppm. The number of boosters was selected to be 2, 3 and 4 for each study category. An incremental increase of 0.05 ppm was utilized in finding out the desirable boosting level. Minimum and maximum allowable FRC concentrations were set to be 0.2 and 0.5 ppm respectively. The transition stage was set as 24 hours. An incremental change of 0.1 % between subsequent iterations was used as stopping criteria for any search. Throughout the experiments, PS is set to 125 individuals and initial population is constituted, randomly. CP and MP values are fixed to 0.85 and 0.01. The search operation is continued until a quality described by Epsilon value of 0.001 is attained. EP is taken as 40%. The results are interpreted as an example considering the properties of the studied pilot system. The interpretations would be system-specific. The results of the optimization are summarized in Tables 2, 3 and 4 in which the values for the magnitudes of objective functions when 2 or 3 or 4 boosters are employed under each objective function activation, respectively.

TABLE II. SUMMARY OF THE RESULTS FROM 4 OPTIMIZATION APPLICATIONS

Rules of optimization: Chlorine boosting range: 0.2-0.5ppm; Number of boosting station: 2; Step size = 0.05 ppm; $C_{min}=0.2$ ppm; $C_{max}=0.5$ ppm; Transition duration= 24 hours; $\epsilon=0.001$

The Objective Function for which optimization was performed →	OF 1	OF 2	OF3	OF4
SSD	53.13094	53.13094	55.39666	62.53932
σ^2	0.006985444	0.006985444	0.007466498	0.008502934
R	0.07868975	0.07868975	0.07042821	0.0946767
THM Formation Risk Index	79.54392	79.54392	81.71689	68.07214
Total FRC rate to consumers (Kg/day)	4.877527	4.877527	4.835087	4.637402

The Objective Function for which optimization was performed →	OF 1	OF 2	OF3	OF4
Nodes →	28 → 0.4	6 → 0.45	28 → 0.45	20 → 0.2
Dosages	6 → 0.45	28 → 0.4	38 → 0.45	28 → 0.2

TABLE III. SUMMARY OF THE RESULTS FROM 4 OPTIMIZATION APPLICATIONS

Rules of optimization: Chlorine boosting range: 0.2-0.5ppm; Number of boosting station: 3; Step size = 0.05 ppm; $C_{min}=0.2$ ppm; $C_{max}=0.5$ ppm; Transition duration= 24 hours; $\epsilon=0.001$

The Objective Function for which optimization was performed →	OF 1	OF 2	OF3	OF4
The calculated values for different objectives ↓				
SSD	49.1786	46.20634	49.32713	62.95487
σ^2	0.006724329	0.007021678	0.007396653	0.007991223
R	0.07445573	0.06346099	0.05307391	0.09525094
THM Formation Risk Index	83.30531	85.50296	87.5571	68.66227
Total chlorine consumption	4.91784 Kg/day	4.969582 Kg/day	4.999735 Kg/day	4.635449 Kg/day

The Objective Function for which optimization was performed →	OF 1	OF 2	OF3	OF4
Nodes → Dosages	38 → 0.4 6 → 0.45 15 → 0.4	38 → 0.45 28 → 0.4 6 → 0.45	7 → 0.45 38 → 0.45 28 → 0.45	28 → 0.2 18 → 0.25 12 → 0.35

TABLE IV. SUMMARY OF THE RESULTS FROM 4 OPTIMIZATION APPLICATIONS

Rules of optimization: Chlorine boosting range: 0.2-0.5.0 ppm; Number of boosting station: 4; Step size = 0.05 ppm; $C_{min}=0.2$ ppm; $C_{max}=0.5$ ppm; Transition duration= 24 hours; $\epsilon=0.001$

The Objective Function for which optimization was performed →	OF 1	OF 2	OF3	OF4
The calculated values for different objectives ↓				
SSD	42.20801	42.20801	46.57488	58.73776
σ^2	0.007041431	0.007041431	0.007240229	0.009021726
R	0.04558521	0.04558521	0.0463766	0.07322767

THM Formation Risk Index	85.36046	85.36046	93.76543	66.70158
Total chlorine consumption	5.053405 Kg/day	5.053405 Kg/day	5.157116 Kg/day	4.644409 Kg/day

The Objective Function for which optimization was performed →	OF 1	OF 2	OF3	OF4
Nodes → Dosages	7 → 0.4 38 → 0.45 28 → 0.4 19 → 0.4	7 → 0.4 28 → 0.4 19 → 0.4 38 → 0.45	7 → 0.45 33 → 0.45 28 → 0.45 19 → 0.45	34 → 0.2 32 → 0.2 28 → 0.2 19 → 0.2

If only 2 boosters are planned and if the minimum risk of exposure is the activated objective function then minimum attainable risk is about 7 % while you have place the boosters at nodes 28 and 38 with boosting level of 0.45 ppm (Table 2). Under these operation conditions, SSD will be 55.39, variance would be 0.0074 ppm, TFRI would be 81.71 and total FRC rate to consumers (in Kg/day) would be 4.83. A similar quantitative assessment is possible for each objective, under each activation and with any selected number of boosters.

If the prime objective is uniformity of the FRC levels within distribution system, the best combinations would be the utilization of 4 pumps with following booster locations of nodes 7, 19 and 28 with 0.4 ppm boosting level; and node 38 with 0.45 ppm boosting level (see Tables 2, 3 and 4). These boosting applications also ensures approximately 4.55 % risk of exposure and very high uniformity of 0.007 ppm variance. The total FRC rate to consumers (in Kg/day) would be 5.03. TFRI would be 85.36.

Figure 9 shows if objective is to minimize SSD, the increase in booster number may help to improve the variability about median. However, if the objective is to minimize variance increase in booster number does not help (Figure 10). As it is clear from Figure 11, utilization of maximum number of boosters is essential to minimize the risk of exposure. It is interesting to note here that similar risk levels are attainable if SSD or variance minimization is activated. The minimum attainable TFRI levels also are insensitive to number of boosters (see Figure 12).

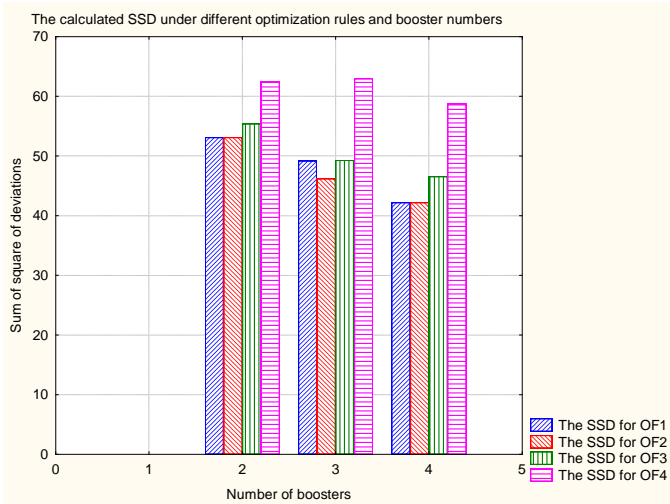

Figure 9. The calculated SSD under different optimization rules and booster numbers.

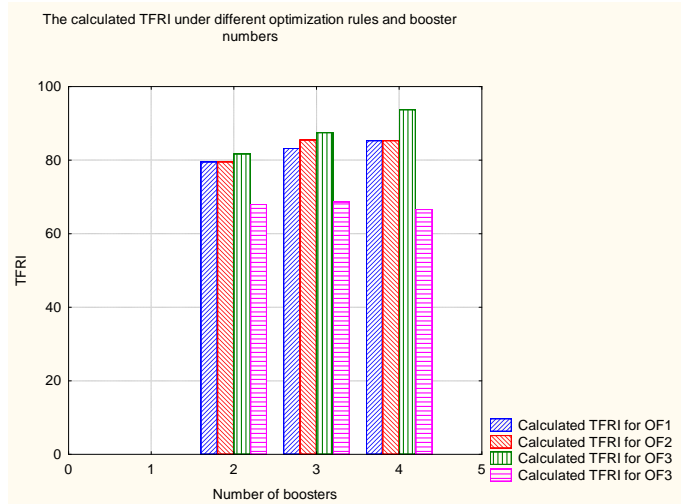

Figure 12. The calculated TFRI under different optimization rules and booster numbers.

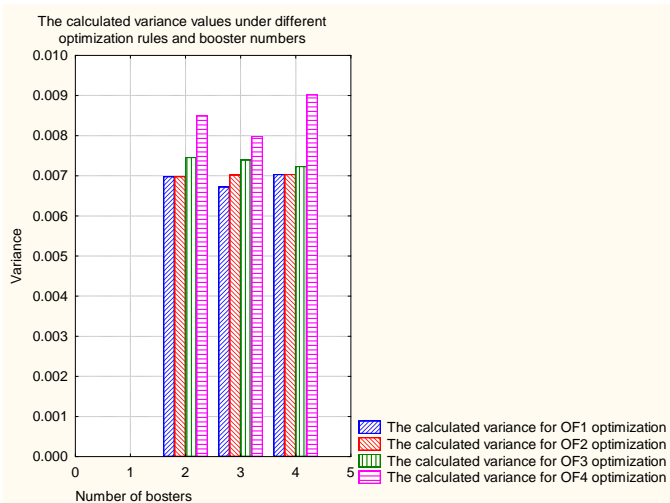

Figure 10. The calculated variance values under different optimization rules and booster numbers.

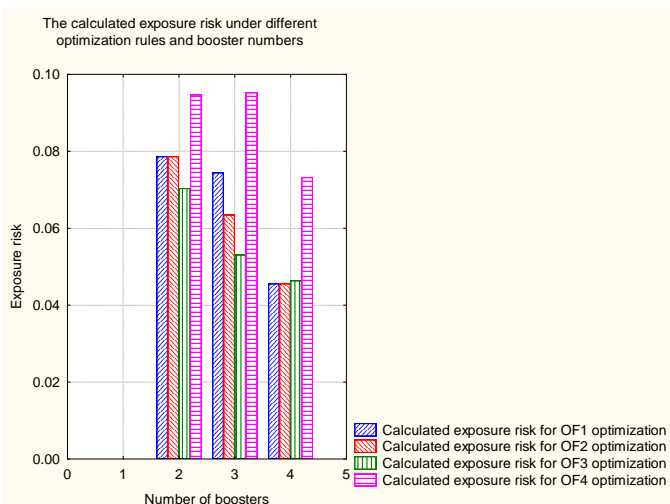

Figure 11. The calculated exposure risk under different optimization rules and booster numbers.

IV. CONCLUSIONS

Decision support software for water distribution system chlorination is developed. The software can be used to answer basic domain questions about: the number, location and dosing regime for booster stations; keeping chlorine utilization at minimum levels in order to minimize system specific trihalomethane formation risk index and reducing the chlorine levels to lower values at the exit of main sources. As a case study, the software is used by domain expert on a hypothetical water distribution network and remarkable results are taken. In practice, using BetterNet improves and speeds up WDS design process. More importantly, it reduces possible unnecessary expenditures due to wrong decisions about boosting station number, location and amount of chlorine to be used. Finally, note that using BetterNet requires a domain expertise in water distribution network design and analysis. Besides from basic knowledge of GA based optimization, the user is still supposed to be able to do hydraulics modeling, calibration and water quality modeling.

Acknowledgments

This research has been supported by The Scientific and Technological Research Council of Turkey, TÜBİTAK (Project No. 107G088), Antalya Water and Wastewater Administration (ASAT) of Antalya Metropolitan Municipality and Akdeniz University, Antalya, Turkey. The authors express their appreciations to the contributing staff members of ASAT with special thanks to Engineers İsmail Demirel, İbrahim Palancı and Tuğba Özden who give valuable feedback for the improvement of the system also to Atılım University during the related thesis works.

References

- [1] T.M. Walski, D.V. Chase, D.A. Savic, W. Grayman, S. Beckwith, E. Koelle, Advanced Water Distribution and Modelling, Heastad Methods, First Edition, Waterbury, USA, 2003.
- [2] Ministry of Health of Turkey, Regulation Concerning Waters Intended for Human Consumption, 2005.
- [3] Y. Levi, J. Mallevalle, Global strategy and new tools for maintaining water quality in distribution system, Proc. of the China Water Supply Association, Safety of Water Supply in Transmission and Distribution Systems, Shanghai, China , 1995.
- [4] J.G. Uber, R.S. Summers, D.C. Boccelli, M.T. Koechling, M.E. Tryby, L.A. Rossman, Booster Chlorination, Proc. of the AWWA Annual Conference, June 23-27, Toronto, Ontario, Canada, Vol D, 1996, pp. 197-202.
- [5] D.L. Boccelli, M.E. Tryby, J.G. Uber, L.A. Rossman, M.L. Zierolf, M.M. Polycarpou, Optimal scheduling of booster disinfection in water distribution systems, Journal of Water Resources Planning and Management, 124(2), 1998, pp. 99-111.
- [6] A. Nace, P. Harmant, P. Villon, Optimization of location and chlorine dosage of the booster chlorination in water distribution network, Proc of the World Water & Environmental Resource Congress, May 20-24, Orlando, Florida. In Phelps and G.Sehlke (eds), Bridging the Gap: Meeting the World's Water and Environmental Resources Challenges, 2001.
- [7] C.J. Rouhiainen, M.O. Tade, G. West, Multi-objective genetic algorithm for optimal scheduling of chlorine dosing in water distribution systems, In Advances in Water Supply Management, (ed. C. Maksimovic, D. Butler & F.A. Memon), Balkema, Rotterdam, 2003a, pp. 459-469.
- [8] C.J. Rouhiainen, M.O. Tade, G. West, Genetic algorithms for optimal scheduling of chlorine dosing in water distribution systems, Proc. of the 20th Convention of the Australian Water Association, 6-10 April, 2003, Perth, Australia, 2003b, pp. 1-16.
- [9] M.E. Ucaner, O.N. Ozdemir, Application of genetic algorithms for booster chlorination in water supply networks, World Water & Environmental Resources Congress and Related Symposia, 2003.
- [10] N. Issam, F. Lebdi, Genetic algorithm for optimal choice of chlorine booster stations in drinking water networks - Algorithmes Genetique (AG) Pour Le Choix Optimal Des Stations D'appoint De Chlorine Sur Les Reseaux D'eau Potable, Revue des Sciences de l'eau, no:1, 2006, pp. 47-55.
- [11] EPANET Programmer's Toolkit, 2000.
- [12] <http://www.epa.gov>, Last accessed in August, 2015.
- [13] M.S. Gibbs, N. Morgan, H.R. Maier, G.C. Dandy, J.B. Nixon, M. Holmes, Investigation into the relationship between chlorine decay and water distribution parameters using data-driven methods, Mathematical and Computer Methods, 44, 2006, pp. 485-489.



Hürevren Kılıç is an Associate Professor of Computer Engineering at Gediz University, Izmir, Turkey. He received his B.Sc., M.Sc. and PhD degrees all in Computer Engineering from Middle East Technical University, Ankara, Turkey, in 1989, 1992 and 1998, respectively. He is an author/co-author of nearly 50 journal and/or conference publications. His research interests include Artificial Intelligence, Multi-Agent Systems and its applications to fields including Water Distribution Networks, Search-Based Software Engineering and Energy Markets.



Selçuk Soyupak is a full-professor of Civil Engineering at KTO Karatay University, Konya, Turkey. He received his B.Sc. from Civil Engineering Department of Middle East Technical University, Ankara, Turkey in 1971; his M.Eng Degree from Civil Engineering Department of McMaster University, Hamilton, Ontario, Canada, in 1976 and his PhD degree from Civil Engineering Department of University of Waterloo, Ontario, Canada, in 1979. He is an author/co-author of about 75 journal and/or conference publications. His current research interests include application of ANN methods in water resources modelling and management problems; water distribution systems modelling and control; and eco-informatics.

About Authors:



Mustafa Kemal Pektürk received his B.Sc. and M.Sc. degrees in Computer Engineering both from Atilim University, Ankara, Turkey in 2008 and 2010, respectively. He is a PhD Student at Computer Engineering Department of Gazi University, Ankara, Turkey. His main expertise/interest areas include Cloud Computing, Decision Support Systems and Software Development.