

# Neural Network Predictive Control of UPFC for Enhancing Transient Stability Performance of a Single Machine Infinite Bus System

Sheela Tiwari

Department of Instrumentation and Control Engineering  
Dr. B. R. Ambedkar National Institute of Technology  
Jalandhar, India

R. Naresh

Department of Electrical Engineering  
National Institute of Technology  
Hamirpur, India

R. Jha

IET Bhaddal Technical Campus  
Ropar, India

**Abstract**— With an increase in power transfer, transient stability is increasingly becoming important for secure operation. With the advent of FACTS devices, the problem of transient stability is being addressed and efforts are under way to utilize the systems to their full capacity. The focus of this work is a neural network predictive controller for a versatile FACTS device, Unified Power Flow Controller, which can be utilized to improve the transient stability performance of the system. A single machine infinite bus system subjected to a 3-phase short circuit fault is used to demonstrate the superior damping performance of the proposed controller in comparison to the conventional PI controller.

**Keywords**—transient stability, neural network, predictive control, UPFC

## I. Introduction

In today's deregulated electric service environment, widely interconnected power supply systems extending from the connections inside utilities' own territories to inter-utility, inter-regional and international connections have become the order of the day. This is resulting into a power system that is increasingly becoming complex to operate and at the same time is also becoming less secure. Such a stressed system is continuously under threat of losing stability following a disturbance. To overcome this problem, the power system planners, engineers and operators have been continuously under-utilizing the existing network by providing greater operating margins and redundancies. In recent times, the availability of high power semiconductor devices for power system applications have led to technologies such as Flexible AC Transmission Systems (FACTS) for secure loading, power flow control and damping of power system oscillations. Of all the FACTS devices, the unified power flow controller (UPFC) is the most versatile and capable of providing stability to the system subjected to transient disturbances due to its ability to control, simultaneously or selectively, all the parameters affecting power flow in the transmission line i.e. voltage, impedance and phase angle [1].

A number of control strategies have been reported for using the UPFC effectively. The most commonly employed controllers for the UPFC have been of the PID (Proportional +Integral+ Derivative) type because of their simplicity and ease in design. However, these controllers suffer from a serious drawback in the form of deterioration in the performance when the system is made to operate under widely ranging operating conditions and subjected to transients. Neural networks have an inherent capability to learn and store information regarding the non-linearities of the system and provide this information whenever required. This renders the neural networks suitable for system identification and control applications [2-7].

This paper presents a neural network predictive controller for the series branch of the UPFC for improving the transient stability performance of a single machine infinite bus system (SMIB). The proposed controller uses a neural network to identify the system and employs predictive control for the system subjected to transients.

## II. UPFC: Principal Operation and Control

A simplified scheme of a UPFC is shown in Fig. 1. UPFC consists of a parallel and series branches, each one containing a transformer, power-electric converter with turn-off capable semiconductor devices and dc circuit.

Converter 2 is connected in series with the transmission line by series transformer. The real and reactive power flows in the transmission line can be quickly regulated by changing the magnitude and phase angle of the injected voltage produced by converter 2. The basic function of converter 1 is to supply the real power demanded by converter 2 through the common dc link. Converter 1 can also generate or absorb controllable reactive power.

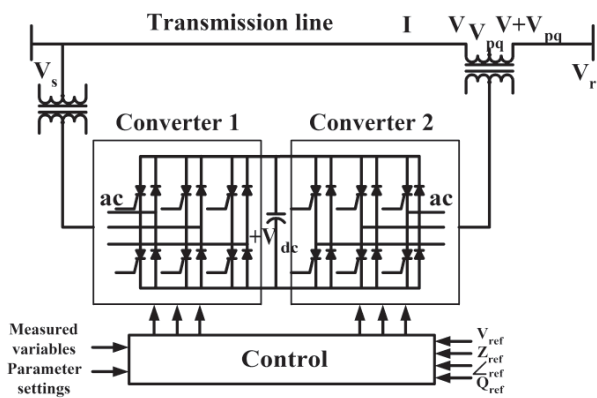

Figure 1. Circuit arrangement of the UPFC.

### III. Neural network predictive control: An overview

Generalized Predictive Control (GPC) was originally developed with linear plant predictor models [8]. For non linear plants, a reasonable model of the plant is required as the quality of the model affects the accuracy of the prediction. Neural networks have been proved to possess an inherent capability to capture the non linear dynamics of a plant. Therefore, the use of a neural network to model non-linear plants instead of using the standard modelling techniques will surely enhance the prediction capability of the GPC. A neural network predictive control (NNPC) system is shown in Fig. 2. An input signal  $r(n)$  is converted into  $y_r(n)$  which is fed to the Cost Function Minimization (CFM) block. Tentative control inputs for specified number of future time instants are first fed to the neural identifier by setting the switch S at position 2 to enable the CFM to use the response from the neural identifier to calculate the next control input. The best control input calculated by the CFM is then fed to the plant by setting the switch at position 1.

### IV. Test system

The system considered to investigate the transient performance of a single machine infinite bus system is as shown in Fig. 3.

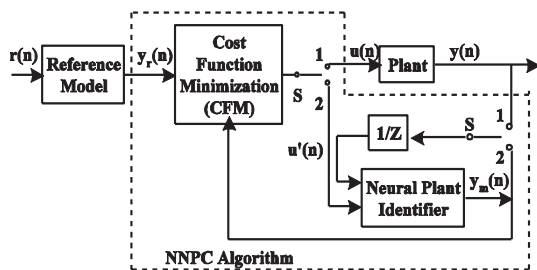

Figure 2. Block diagram of the NNPC system.

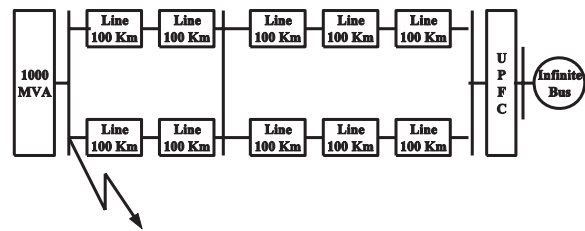

Figure 3. Block diagram of the test system.

The generator is of 1000-MVA, generating at 15.7KV. The transmission system comprises of 400-kV double lines 500 km long divided into two sections, 200 km and 300 km long. The UPFC is connected at the infinite bus. Therefore the voltage magnitude control by the shunt converter is not considered limiting its function to supply/absorption of real power at its dc terminals as demanded by the series converter. This system has been simulated using Matlab \Simulink.

### V. Neural network predictive control: Design and Algorithm

The proposed neural network predictive controller employs a neural network for identifying the non linear test system under consideration. The neural identifier in Fig. 4 that identifies the test system (including the UPFC) under consideration uses the current value and the value at three previous instants of the quadrature component of the series injected voltage  $V_q$  and the active output power  $P$  at four previous instants as inputs to predict the current value of the active output power. Hence, it is a two-layer feedforward neural network with 8 inputs, a single hidden layer with 15 sigmoidal neurons and one linear output neuron. The data required for training the network is generated from simulation of the operation of the test system under consideration by applying randomly generated values for  $V_q$  to the plant at regular intervals of 0.03125 second. The Backpropagation algorithm employing the Levenberg-Marquardt algorithm for faster convergence is used to train the neural network shown in Fig. 4 to identify the plant.

The proposed neural network predictive controller is based on the receding horizon technique. As the rotor angle oscillations are to be damped by controlling the active power  $P$  effectively to the steady state level, the controller minimizes the difference between the actual value of the active power and its steady state value over some specified future time horizon. It also minimizes the deviation in the control action making it smooth and ensuring its steady state behavior. The actual value of the active power at future time instants corresponding to the tentative control inputs are predicted by the neural identifier. The cost function used in this work employs the Integral Square Error (ISE) criterion. It consists of squared deviations between the reference and predicted active power values and the weighted square of the change in control input over successive future time instants given as:

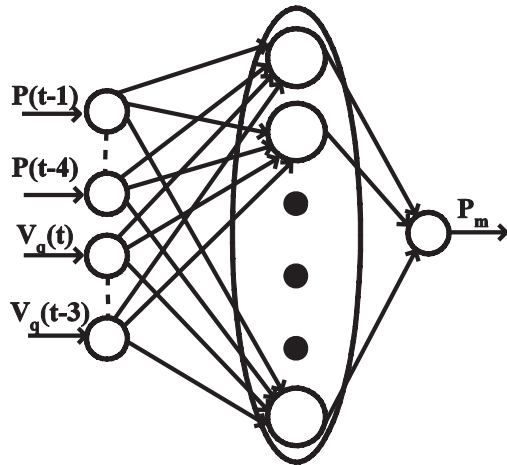

Figure 4. Structure of the neural network identifier.

$$C = \sum_{j=N_1}^{N_2} (P_{oref}(t+j) - P_m(t+j))^2 + \rho \sum_{j=1}^{N_3} (V_q'(t+j-1) - V_q'(t+j-2))^2 \quad (1)$$

where  $P_m$  is given by the neural identifier,  $V_q'$  is the tentative control input and the active power reference  $P_{oref}$  is obtained from the steady-state power flow requirements by simulating the test system in MATLAB / SIMULINK. The cost function stated above (1) is minimized using the damped Gauss-Newton method [9], an optimization technique meant for the non linear squares problems.

## VI. Simulation Results and Discussion

The system under consideration is simulated under different operating conditions to investigate its transient stability performance and to demonstrate the effectiveness of the proposed controller. The contingency under consideration is a three phase fault at the sending end of one of the transmission lines when the generator is operating at different power levels. The fault is considered to occur between  $t=0.2s$  and  $t=0.4s$ . The fault is cleared with the operation of transmission line reclosure. The following case studies were undertaken to make the assessments:

1) *Case 1:* The SMIB system under consideration was simulated without UPFC at 40% and 55% of the rated capacity and was subjected to the said transient. The transient stability performance of the system is satisfactory at these power levels as shown in Fig. 5 and 6 even without the UPFC in the system.

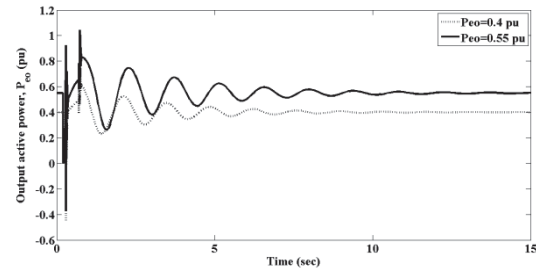

Figure 5. Electrical power output oscillations at different power levels.

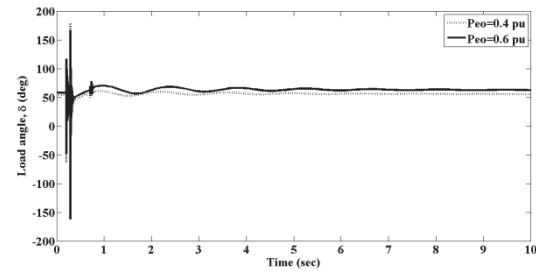

Figure 6. Load angle oscillations at different power levels.

2) *Case 2:* The system under investigation is operated at 65% of the rated capacity without UPFC. The response of the system without the UPFC is as shown in Fig.7 and 8. The system is found to be unstable with undamped electrical power and rotor angle oscillations. Additional control is required to stabilize the system.

3) *Case 3:* The system under investigation is again operated at 65% of the rated capacity but with a UPFC employed for improving transient stability performance of the system. Fig. 9 and 10 show the electrical power output and rotor angle oscillations for this case. These figures provide a comparison between the performance of the conventional PI controller and the proposed controller. The PI controller is tuned manually to reduce the overshoot during transient at this operating point. The value of the quadrature component of the series injected voltage for both the controllers is shown in Fig.11. The proposed controller requires smaller voltage values ( $< 0.45 pu$ ) for  $V_q$  as compared to the PI controller, which injects  $V_q$  equal to  $0.6 pu$  for stabilizing the system.

4) *Case 4:* The UPFC equipped system under consideration is simulated at 70% of the rated capacity and subjected to the same transient. The electrical power output and rotor angle oscillations are shown in Fig. 12 and 13. The PI controller tuned for case 3 fails to stabilize the same system, when operated at a slightly higher power level. However, the proposed neural network predictive controller continues to perform satisfactorily. The quadrature component of the series injected voltage is shown in Fig 14. The value of  $V_q$  injected by the proposed controller to stabilize the system is still less than  $0.45 pu$ .

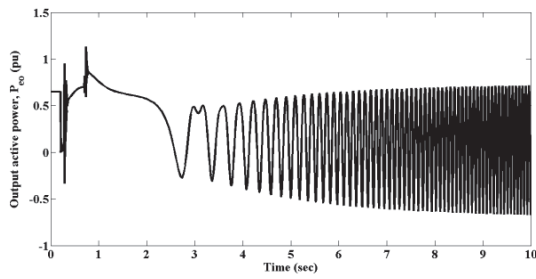

Figure 7. Electrical power output oscillations at  $P_{eo} = 0.65$  pu.

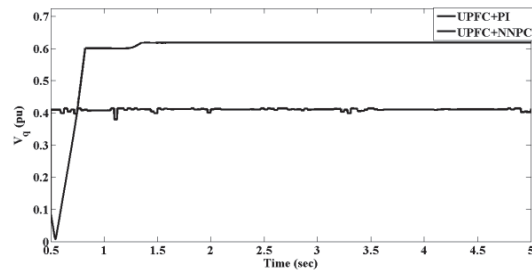

Figure 11. DC capacitor voltage characteristics at  $P_{eo} = 0.65$  pu for different control schemes.

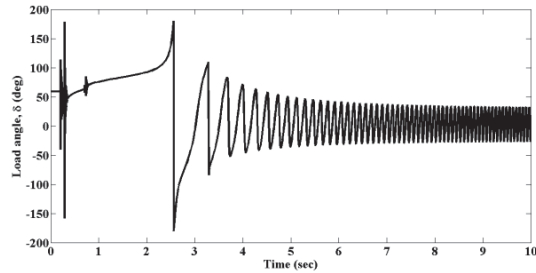

Figure 8. Load angle oscillations at  $P_{eo} = 0.65$  pu.

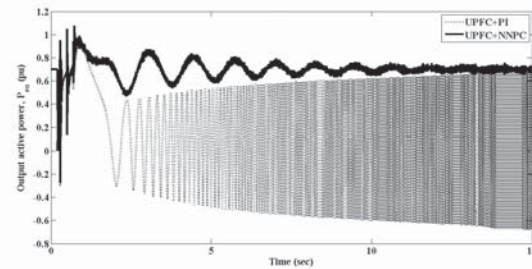

Figure 12. Electrical power output oscillations at  $P_{eo} = 0.70$  pu for different control schemes.

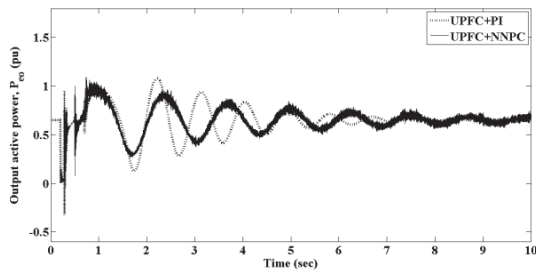

Figure 9. Electrical power output oscillations at  $P_{eo} = 0.65$  pu for different control schemes.

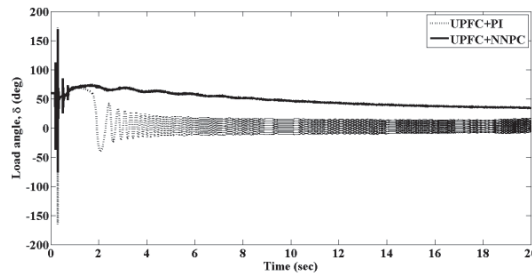

Figure 13. Load angle oscillations at  $P_{eo} = 0.70$  pu for different control schemes.

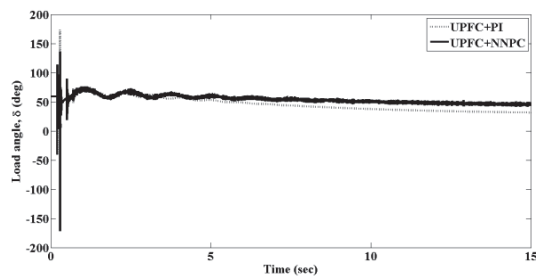

Figure 10. Load angle oscillations at  $P_{eo} = 0.65$  pu for different control schemes.

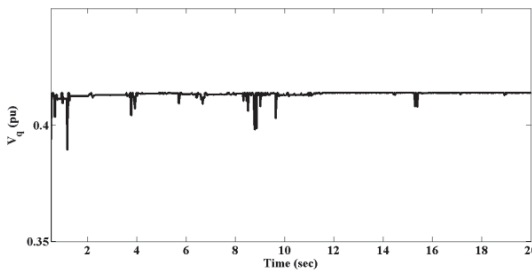

Figure 14. DC capacitor voltage characteristics at  $P_{eo} = 0.70$  pu

## VII. Conclusion

The system under consideration exhibited improved transient stability performance at higher power levels after being equipped with the UPFC. The performance of the proposed controller is investigated in the system under consideration. This controller damps the electrical power output and rotor angle oscillations in the system very effectively. It performs satisfactorily even at those operating points where the PI controller fails to stabilize the system. The proposed neural network predictive controller hence, provides a significant improvement in the transient stability performance of the system under consideration over a wide range of operating conditions.

### APPENDIX

*UPFC ratings:* Series converter = 160 MVA  
Shunt converter = 160 MVA

$V_{dcbase} = 126kV$   $C_{dc} = 120.94\mu F$

*Neural network predictive controller data:*

$N_1=1$   $N_2=5$   $N_u=5$  Control weighting factor,  $\rho = 0.3$

## References

- [1] N.G. Hingorani, L. Gyugyi, Understanding FACTS: Concepts and Technology of Flexible AC Transmission Systems, first ed., IEEE Press, Delhi, 2000.
- [2] C.C. Chu, H.C. Tsai, Application of Lyapunov-based adaptive neural network UPFC damping controllers for transient stability enhancement, in: Proceedings of IEEE Power and Energy Society General Meeting- Conversion and Delivery of Electrical Energy in the 21st century, 2008, pp. 1-6.
- [3] P.K. Dash, S. Mishra, G. Panda, A radial basis function neural network controller for UPFC, IEEE Trans. Power Syst. 15 (November(4)) (2000) 1293-1299.
- [4] G.K. Venyagamoorthy, R.P. Kalyani, Two separate continually online-trained neurocontrollers for a unified power flow controller, IEEE Trans. Ind. Appl. 41 (July/August(4)) (2005) 906-916.
- [5] S. Mishra, Neural network based adaptive UPFC for improving transient stability performance of power system, IEEE Trans. Neural Netw. 17 (March (2)) (2006) 461-470.
- [6] V. K. Chandrakar, A. G. Kothari, Comparison of RBFN based STATCOM, SSSC and UPFC controllers for transient stability improvement, in: Proceedings of IEEE Power Engineering Society Power Systems Conference and Exposition ( PSCE) Atlanta, USA, October 29-November1, 2006, pp. 784-791.
- [7] Sheela, Tiwari, Ram, Naresh, R. Jha, Neural network predictive control of UPFC for improving transient stability performance of power system, Applied Soft Computing 11 (2011) pp.4581-4590.
- [8] D. Soloway, P.J. Haley, Neural generalized predictive control- A Newton-Raphson implementation, in: Proceedings of IEEE International Symposium on Intelligent Control, Michigan, USA, September 15-18, 1996, pp. 277-282.
- [9] J.E. Dennis, R.B. Schnabel, Numerical Methods for Unconstrained Optimization and Nonlinear Equations, SIAM, Philadelphia, 1996.