

Designing and Performing of Serum Flow Rate by Microcontroller

[Sabri KOCER , M. Rahmi CANAL, Fecir DURAN, Meral Ozarslan YATAK, Serdal GUVENC]

Abstract—Drug injection together with serum to vessel of patient is one of drug treatment (medication) methods. In this method it is necessary that drug must be given on the certain frequencies and within certain dosages during treatment to patient. Therefore serum should be injected to patient by very sensitive systems. In performed study control of serum flow rate was carried out by drop counting method without using another addition piece apart from standard serum sets. Because of control process of flow rate was performed the that way, automatically compressing and losing by engine of serum hose, any physical interference which would be made to serum system was blocked. Hereby more sterile treatment environment was created. Additionally there was provided possibility for more sensitive treatment while user inform is performed by LCD screen which is placed on it.

Key words: Microcontroller, drug treatment, drop counting method, serum flow rate.

I. Introduction

For in-patients drug injection through vessel is one from vital treatment methods. During this treatment it may be necessary that drug injection must be given on the very often intervals and at the very low dosage from vessel. Particularly it may be necessary that intravenous (IV) chemotherapy drugs should be given on the variable times from half an hour up to several hours and even to several days. Infusion pumps have been considerable common used at cases that drug must be given for long time period especially at the chemotherapy treatment [1, 2].

Many different types of infusion devices are available in the market. Each has its own characteristics and serves some special applications. In general, infusion devices can be divided into two main groups: gravity flow infusion devices and infusion pumps. A gravity flow infusion device relies on the gravitational force exerted by a liquid column to push the fluid via a venous access into the patient's bloodstream, whereas an infusion pump has a motorized pumping mechanism to generate the positive pressure. Within the gravitation group are the manual gravity flow sets and the infusion controllers. There are two types of pumps in the infusion pump group: volumetric and syringe. Within the volumetric pump group are three different pumping mechanisms: piston cylinder, diaphragm, and peristaltic pumping mechanisms [3-5].

Major developments in the new infusion pumps have happen in parallel with technological development. In the previously methods due to mistakes and breakdowns of its pump mechanism, uncontrolled drug administration to patients might cause lethal results. Together with technological developments this risk has been nearly removed and infusion pumps have been brought to more reliable status. Besides other important properties of new infusion pumps are advanced control system, easiness of their system using and being portable [1-4].

Whereas in the designed and performed system, natural period which is at the serum injection to patient has been controlled. During this control period drops with constant volume which are dropping to serum canister was countered and serum flow rate was controlled by means of compressing and losing by required process of serum hose. System elementarily consists of three main parts. These are drop counter, keyboard (key pad) and microcontroller and finally DC extrusion engine

II. Material and Method

Infusion pump (drip-feeding pump) doses fluids or medication into a patient's circulatory system. The advantages of controlled perfusion (in time and in liquid temperature) become very important in treatment and recovery of many diseases. Such devices can perform different programs, in ways that would be impractically expensive or unreliable if performed manually by nursing staff: they can administer very small quantities per hour (too small for a drip), injections every minute, or fluids whose volumes vary by the time of day. These systems require high-performance electronics for a precise control [6-8].

An infusion controller overcomes the problem of flow rate variation by automatically adjusting the regulating clamp. Fig. 1 shows the setup of an infusion controller. Performed system consists of drop counter sensor, comparator, microcontroller, motor drive, DC extrusion engine with redactor, imaging unit, keyboard and alert parts with audible and light.

An infusion controller monitors the flow rate by counting the drops in the drip chamber. A typical drop sensor consist of an infrared (IR) light emitting diode (LED) and an infrared light sensitive transistor, each located on the opposite side of the drip chamber.

Sabri KOCER,
Necmettin Erbakan University, Faculty of Engineering, Computer
Engineering Meram/KONYA TURKEY
To whom correspondence should be addressed

M. Rahmi CANAL, Fecir DURAN, Meral Ozarslan YATAK, Serdal GUVENC
Faculty of Technical Education, Gazi University Faculty of Technology,
Computer Engineering Teknikokullar, ANKARA, TURKEY.

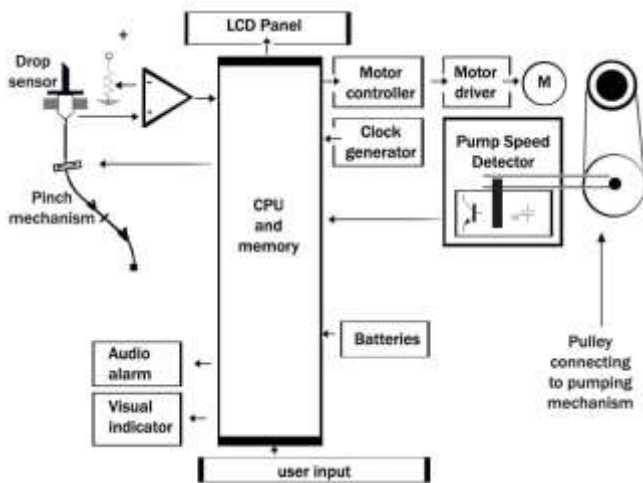

Figure 1. Functional Block Diagram of Volumetric Infusion Pump

A fluid drop from the solution bag interrupts the optical path and produces an electrical pulse. The flow rate is computed from the drop rate and the drop size. The calculated flow rate is then compared to the settings. If it is lower than the setting, the pinching force of the pinch mechanism will be released to allow more fluid to flow through. If it is higher, it will increase the pinching force to reduce the flow. Such a feedback mechanism maintains a constant flow rate equal to the setting. Although it automatically regulates the fluid flow rate, an infusion controller still relies on gravitational force to generate the infusion. If there is some restriction in the infusion line, the gravity pressure created by the liquid column may not be sufficient to produce the desired flow rate [4, 9-11].

This study is performed by PIC16F877. This microcontroller with 40 legs having a flash program memory of 8Kx16 word and a CPU speed which can be elevated to 20 Mhz is the reason of it to be preferred.

Infrared receiver and transmitter are used within the system as drop counter. Drop counting operation is performed as these detectors being attached on the chamber over the serum set. When the drop passes among the receiver and transmitter detectors it cuts the transmission in between and changes the light amount reflected on the base of receiver photo transistor. And this causes a small amount of increase at the potential on the output of the drop counter. Signals with small amplitude from the drop detector is compared at the comparator with the required reference value and thus increased at the output to the level that can be processed in the microcontroller. Signals from the drop detector at the input of the comparator and signal composed at the output of the comparator are shown in Fig. 2.

The first signal is the one with low amplitude from the drop counter. The first peak signal composed is the signal composed when the drop enters in between the detectors and the second peak signal is the signal composed when the drop exits from the detectors. The wave from below indicates the wave form of the signal composed at the output of the comparator.

The magnitude of this signal is a small one and it is converted to logic 1(+5V) and logic 0 (0V) levels as being compared by the reference value determined at the

comparator in order to be detected at the microcontroller. An impact is composed at the output of the comparator for each drop dropping in the chamber of the serum set and the counting operation is performed as this impact being sent to the microcontroller

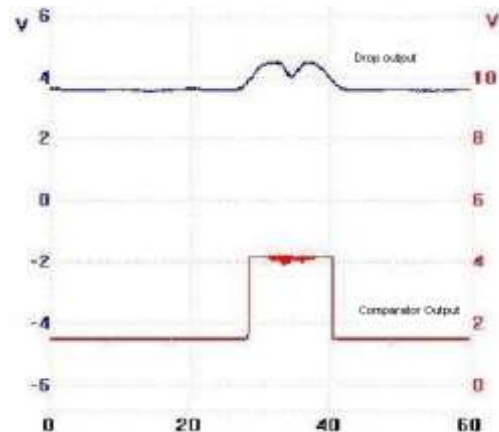

Figure 2 Input and output wave figures belong to comparator

An infusion pump contains a motor-driven pumping mechanism to produce a net positive pressure on the fluid inside the infusion line. With the pumping mechanism, infusion pumps produce a more controlled and consistent flow than infusion controllers [4, 9-11]. DC engine with reducer is used for the control of serum flow within the system. This engine which can perform 50 rotations at 5V voltage can adjust the flow amount depending on the condition by tightening and loosening the serum hose. Engine drive circuit providing the engine control is composed of 4 units of transistors connected as H Bridge. The signal transmitted from the microcontroller to engine drive is transferred to the DC engine as being processed. As a result of these signals the liquid flow amount at the serum set is adjusted by the serum hose being tightened and loosened as required by a shaft adhered to the DC engine with reducer.

III. Software of the Circuit

When the system is started the selection of one of the serum sets is expected from the user by the "select set" key on the keypad. There are differences at standard serum sets in respect of flow amount. In these sets 15 drops, 20 drops or 60 drops are equal to 1ml depending on its type. The set selection at start can be observed from the warning led's on the right of the keypad and from the LCD display. Another key on the keypad is the "open/close" key. As the serum set will be directly connected to the system DA tightening engine is let free by the "open/close" key and thus the hose of serum set is placed in its slot. By pressing the same key again the tightening engine to tighten the hose in provided and thus the serum flow is prevented. In the same manner, if there remained any air within the serum it shall be extracted by this key. "Limit key" provides to enter the limit value to the system which does not occur at start. The serum amount required in a minute is adjusted by the up-down direction keys. When total serum amount injected into the system reached the limit value the serum flow is cut by the tightening engine tightening the serum hose.

The operation is approved when the required adjustments regarding the system are performed and “enter” key is pressed. Now all the adjustments are performed and the serum being injected to the required value is ensured by pressing the “start” key. On the right upper edge of the keypad there exists “clean-up” key. The duty of this key is to provide the reset of the total serum amount while the program is on the main menu.

System tests itself at start as it is observed by the flow chart in Fig. 3. This test is composed of three stages. On the first stage the engine whether letting loose the serum hose or not, on the second stage the engine whether tightening the serum hose as required or not, and on the third stage the drop counter whether operating properly or not and the communication between the receiver and transmitter are observed. When the system succeeds in this test program passes to the main menu screen. When the test fails the system gives audio warning and the source of error is displayed on the screen. When the error is removed and the enter key is pressed system tests itself again and when no error occurs it passes to the main menu screen.

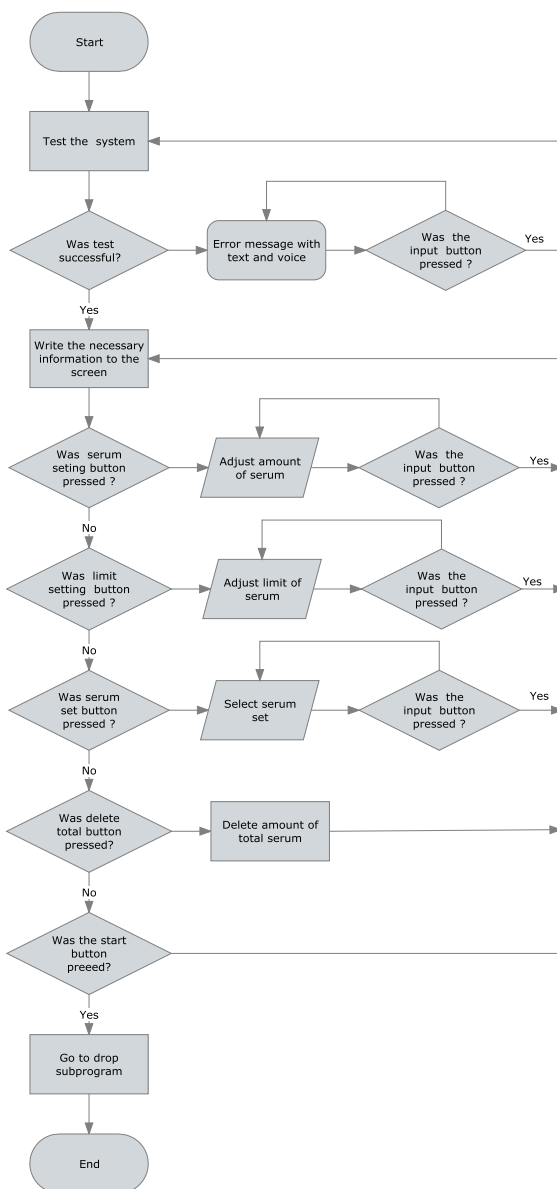

Figure 3 System tests itself at start as it is observed by the flow chart

On the main menu screen the user is expected to select the required serum adjustments. On this menu the serum amount required, total serum amount, serum limit and type of the used serum set are indicated. When all the adjustments are entered by the keypad the system will be ready to control the flow of the serum. When the “Start” key is pressed drop counters will be activated and drop counting operation starts. Drop counting operation repeats at each cycle and the engine to tighten and loose the serum hose is provided according to the values entered by the keypad. Thus the total serum amount is indicated on the screen at the end of each cycle. If the serum limit value is not entered then there is no limit. If a limit value is entered total serum amount injected within each cycle is compared by the limit value and when the total value reaches the limit value the injection of serum is concluded by an audible warning.

IV. Test Results and Examination

On the researches made the models of the infusion pumps, their utilization and operation form are examined. By the obtained information, a system is designed and performed which controls the serum flow in the direction of determined values. The method used in order to measure the flow rate of serum is drop counting method. The relation between the drop counter and drop volume is examined considering each drop having a specific volume. After various calculations performed at the microcontroller various tests are performed in order to determine the system result. In these tests the serum amount required in a minute is entered into system by the user and the precision of the system on measurement is determined by comparing this value entered and the value measured by oscilloscope. On the first test serum amount per minute is considered as 3ml, on the second as 10ml and on the third as 20ml. Limit value is not adjusted on all the three tests. On the serum set used 20 drops are equal to 1ml. On Fig. 4, Fig. 5 and Fig. 6 the results of the measurements performed are shown.

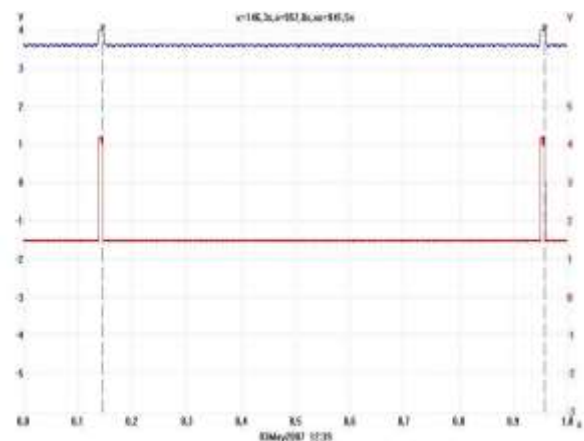

Figure 4. The results of the measurements, while serum amount per minute is 3ml

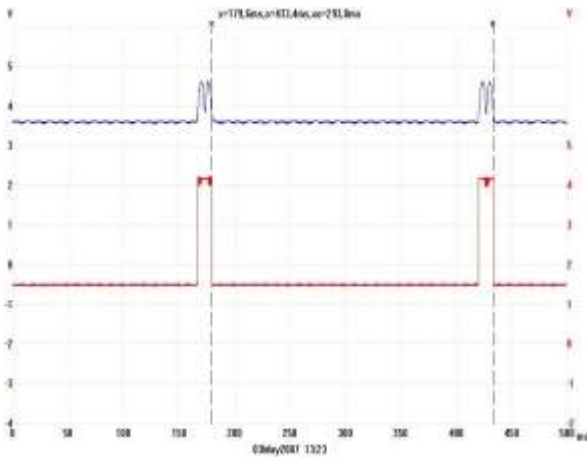

Figure 5. The results of the measurements, while serum amount per minute is 10ml

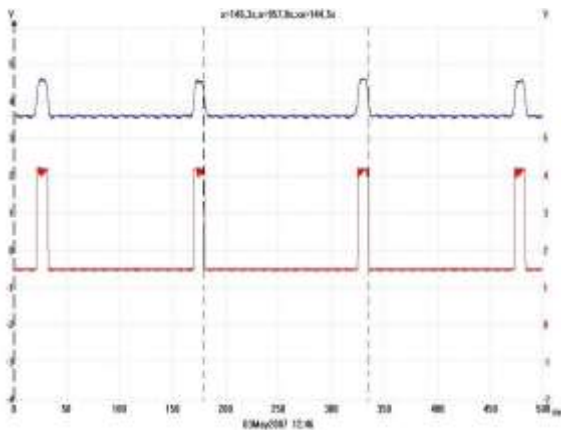

Figure 6. The results of the measurements, while serum amount per minute is 20ml

As it is observed from the test results in Table 1, when the serum amount required per minute decreases the rate of error increases. The reasons of this unnecessary condition are losses at calculations performed within the program and DC engine used not being at the required precision. Another problem arising from the engine not having sufficient precision and power is the leakage of serum when it is required to be cut-off completely. The usage of an engine with a lower rotation and being more powerful can resolve these errors.

TABLE 1 SYSTEM TEST RESULTS

| | Time measurement between two drop (ms) | Necessary ml/dk value | Measure ment value (ml) | Difference between two value (ml) | % Error |
|-------|----------------------------------------|-----------------------|-------------------------|-----------------------------------|---------|
| Test1 | 941ms | 3 | 3.18 | 0.18 | 6 |
| Test2 | 293ms | 10 | 10.2 | 0.6 | 2 |
| Test3 | 144ms | 20 | 20.3 | 0.3 | 1.5 |

And in another test performed on the system the total serum amount whether being equal to the required serum amount or not is examined (Table 2). In here it is observed that when the serum amount flowing per minute increases, it is observed that difference between the entered and measured total serum decreases.

TABLE 2 SYSTEM TEST RESULTS

| | Entered total serum (ml) | Measured total serum (ml) | Difference between two serum value | % Error |
|-----------------|--------------------------|---------------------------|------------------------------------|---------|
| Test1 (3ml/dk) | 150 | 160 | 10 | 6.6 |
| Test2 (10ml/dk) | 150 | 155 | 5 | 3.3 |
| Test3 (20ml/dk) | 150 | 153 | 3 | 2 |

v. Results and Recommendation

The importance for human health increases each day. Thus the systems used at health institutions shall be secure as not to endanger human health; fast as to ensure saving from time and easy to use.

Modern infusion pumps improve medical activity in any hospital. The use of electronics brings new features like infusion of very small quantities per hour (too small for a drip) or infusion of fluids whose volumes vary by the time of day. Modern system-on-chip microcontrollers allows on-chip solutions for infusion pumps and offer enough processing and memory reserves for further improvements

In this study, a system is performed where the serum flow amount is calculated by the method of counting drops and which controls the flow rate. The system is made flexible by the utilization of PIC 16F877 microcontroller so that the next changes required to be made can be performed easily. Drop counting system is performed by a small cost in respect of electronic and mechanic pieces used. Thus the practicability of the system is increased. In this system the serum amount is controlled and delivery of required amount of serum to the patient is ensured. The system is designed as to close itself when the serum flow amount reaches the predetermined limit value; and designed as to give an audible warning when a problem occurs within this process.

It is possible to increase the precision of the system by developing the system designed. Furthermore the peristaltic pump or peristaltic finger pump addition to be made on the system can be improved. But in this form the pressure at the output of the pump shall be continuously measured. A system made more useful by decreasing the dimensions and adding battery is always a reason of preference.

References

- [1] "Safe Intravenous Infusion Systems", <http://www.coesafety.bwh.harvard.edu/linkPages/projectsPages/project4.htm> (18.03.2007).
- [2] Leor, R.; Rabinowitz, B.; Kaplinsky, E., 1989, "A system for the measurement of drop volume of intravenous solutions," Computers in Cardiology, Proceedings. , vol., no., pp.405-406..

- [3] RhindII, A. W. Anjanappa M., 1999, Microcontroller-based sensor to measure serum column height, *Mechatronics*, Volume 9, Issue 4, Pages 329-348.
- [4] Chan A. Y. 2008, *Biomedical Device Technology Principles and Design*, Charles Thomas Publisher.
- [5] Velichkov I.V., Drobin V.M., 1990, Capacitance level meters for cryogenic liquids with continuous read- out. *Cryogenics*; 30(6):538±44.
- [6] Drumea, A.; Vasile, A.; Vulpe, V.; Svasta, P., 2007, "Remote Control Module for Infusion Pump Medical Device," *Electronics Technology*, 30th International Spring Seminar on , vol., no., pp.517-520.
- [7] Drumea, A.; Vasile, A., 2006, "Infusion pump medical system controlled with modern system on chip devices," *Electronics Technology*, 2006. ISSE '06. 29th International Spring Seminar on , vol., no., pp.382-385.
- [8] JMS Co., Ltd., OT-701 Infusion Pump, Operator's Manual.
- [9] T. Heruth ve K. 1998, "Medtronic SynchroMed Infusion System", *Electronically Controlled Drug Delivery*, CRC Pres, London, 175-180.
- [10] Ranade V., Hollinger M., "Drug Delivery Systems", 2003, CRC Pres, London, 117-122.
- [11] Dorman, F.D.; Wigness, B.D.; Rohde, T.D.; Beling, W.L.; Buchwald, H., 1989, "A new spring-driven implantable drug infusion pump," *Engineering in Medicine and Biology Society, Images of the Twenty-First Century.*, Proceedings of the Annual International Conference of the IEEE Engineering in , vol., no., pp.1538-1539, vol.5.



He graduated from the Faculty of Technical Education, Electronic Computer Education, Department of Gazi University. He completed his graduate in Gazi University. Electronics and biomedical studies in the area.



He graduated from the Electrical Engineering Department of Selcuk University. He completed his graduate and his doctorate in Gazi University. Currently, Necmettin Erbakan University, Faculty of Engineering, Computer Engineering is working. Electronics, Computer, Telecommunication and biomedical studies in the area.

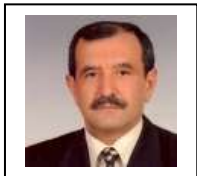

He graduated from the Faculty of Technical Education, Electronic Computer Education, Department of Gazi University. He completed his graduate and his doctorate in Gazi University. Currently, Gazi University Faculty of Technology, Computer Engineering is working. Electronics and biomedical studies in the area.



He graduated from the Faculty of Technical Education, Electronic Computer Education, Department of Gazi University. He completed his graduate and his doctorate in Gazi University. Currently, Gazi University Faculty of Technology, Computer Engineering is working. Electronics and Microcontroller studies in the area.



She graduated from the Faculty of Technical Education, Electronic Computer Education, Department of Gazi University. She completed his graduate and his doctorate in Gazi University. Currently, Gazi University Faculty of Technology, Computer Engineering is working. Power Electronics, DSP and Control studies in the area.