

Biomimetic Flapping Wing Aerial Vehicle

Nishant Jain, Isha Atreja

UG Student, Deptt. of Aeronautical & Automobile Engg.
Manipal Institute of Technology, Manipal University
Manipal-576104, Karnataka, India

Dr. Satish Shenoy B.

Associate Prof., Deptt. of Aeronautical & Automobile Engg.
Manipal Institute of Technology, Manipal University
Manipal-576104, Karnataka, India

Abstract— The aim of the project is to develop a flapping wing aerial vehicle (FWAV) designed using a biomimetic approach; replicating the flying patterns of birds. The development of FWAV is complicated and it involves light weight design, power transmission design, flight controls, low Reynolds number flight, energy supply, etc. An angle of attack is generated during each wing stroke by a spatial mechanism that is driven by a rotary actuator. A 129g, 927mm span two wing prototype has been developed. It is capable of producing required lift and thrust. The FWAV prototype produces a symmetric and steady flapping motion.

Keywords— Aerial vehicles, biomimetic, flapping wing aerial vehicle (FWAV), non-autonomous, spatial mechanism, unmanned aerial vehicles.

I. INTRODUCTION

Unmanned aerial vehicles (UAVs) have a range of applications like military, surveillance, search-and-rescue, etc. Current research interest across the world is focused on developing miniature aerial vehicles (AVs) modeled on the aerodynamics of birds and insects. Many hand-launched AVs demonstrating forward flight have been developed like the Microbat [1] and Delfly [2]. Flapping wing aerial vehicles (FWAVs) have substantial advantages over traditional vehicles: low noise signature, high efficiency at smaller scales, low Reynolds's number, survivable and robust. The analysis of flapping wing motions of natural fliers is crucial as they provide clues to design better flying machines at smaller scales [3].

The flapping patterns of flying creatures consist of a flap or stroke and rotation or twisting of the wing which can be divided into two types of flapping wing mechanisms: active and passive. An active mechanism is one in which wing rotation is generated by actively rotating the wing to generate an angle of attack during each stroke [3, 4, 5, 6, 7, 8]. A passive mechanism uses aerodynamic drag and the flexibility of the wing to generate wing rotation [1, 2, 3, 9].

A. Classification of UAVs

- Fixed wing
- Rotary wing
- Ornithopter
- Entomopter

Fig. 1 shows the types of UAVs.

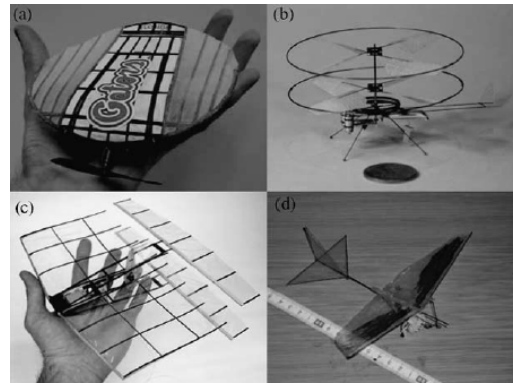

Figure 1. MAVs: (a) flexible fixed wing [10] (b) rotary wing [11] (c) hybrid flapping-fixed wing, with the fixed wing used for lift and the flapping wing for thrust [12] and (d) flapping wing for both lift and thrust [13]-[14].

Biological wings are elastic structures which deform under aerodynamic loads. The wing structure is composed of a thick and heavy leading edge and light wing surface made up of thin veins embedded in membrane as shown in Fig. 2. The complex wing motion can be decomposed into flapping and rotation. We have focused on flapping motion. In birds the flapping motion is brought about by the thorax muscles and involves transverse elastic bending near the wing base [15].

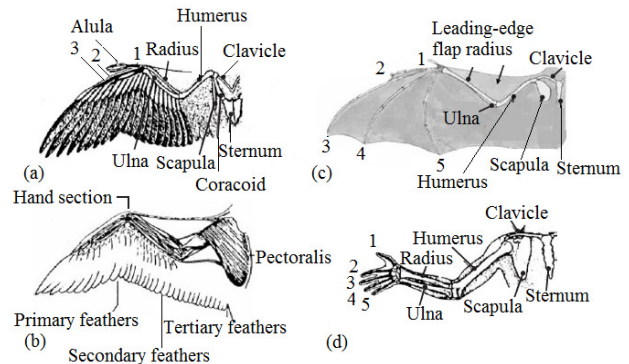

Figure 2. Schematics of (a), (b) a bird wing, (c) a bat wing, and (d) a human arm. For birds, the upper arm, the "humerus," is proportionately shorter; the "wrist" and "palm" bones are fused together for greater strength in supporting the primary flight feather. (a), (b) and (d) are modified from [16]; (c) is adopted from [17]-[14].

Motivated from this study, we have designed a flapping mechanism which is a simplified variant of the complex biological wing. The wing consists of a stiff circular leading edge spar (3 x 2mm carbon fiber rod) attached to a light flexible wing surface [15].

B. Design Procedure

The design goal is to generate enough lift ‘L’ to support the weight ‘mg’ of the FWAV from the available actuator output power ‘P_o’ [15]. Fig. 3 outlines the adapted design procedure.

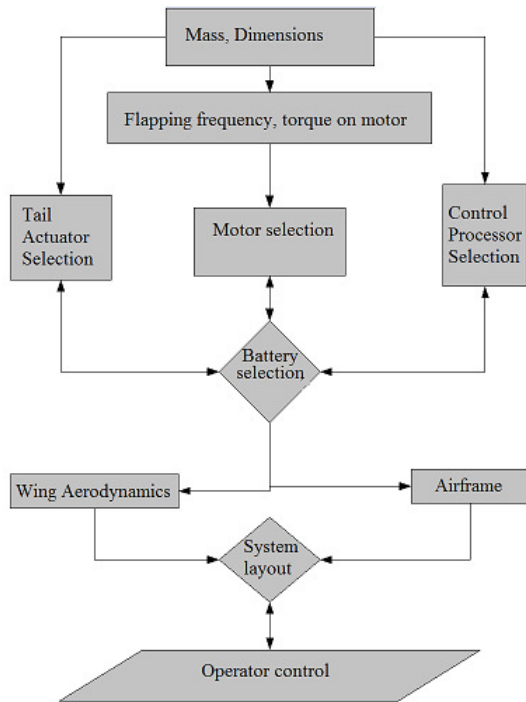

Figure 3. Design flowchart [18]

C. Spatial mechanism

A symmetric angle of attack during upward and downward strokes is generated through the schematic diagrams shown in Figs. 4 – 7. Here the actuator generates flapping motion. This mechanism will be beneficial in building a light and miniature aerial vehicle [3].

II. PROTOTYPE

A. Design

The weight distribution of the prototype is laterally symmetrical. The motor, LiPo (lithium polymer) battery and electronic speed controller (ESC) are placed as low as possible to impart a low center of gravity: passive stabilization. The wing comprises of a stiff circular leading edge (LE) spar attached to a light wing surface. Flexible wing has been designed as it provides extra lift force. The prototype has been built using carbon fiber (CF) rods and plates. Table 1 and 2

summarize the details of components and the prototype respectively.

TABLE I. COMPONENT DETAILS

Component	Specification
Motor	25g, 1400kV, DC Brushless
Electronic speed controller	9g, 10A Brushless ESC
Servo	2 sub-micro servos, 2.5g
Battery	16.94g, LiPo, 7.4V, 250mAh
Receiver	15.167g, 2.4 GHz 6-Channel
CF plate	1mm thick
CF rods	3 x 2mm, 2mm

TABLE II. PROTOTYPE DETAILS

Type	Parameter
Dimensions	927mm x 50mm x 392mm (span x height x length)
Gross weight	129g
Wing Area	1220.75cm ²
Fuselage Length	180mm
Angle of attack	5°
Aspect ratio	7.039
Flapping Frequency	4 Hz
Passive stabilization	Lower center of gravity
Flight Duration	2.5 min

B. Components

- Brushless Motor
- ESC
- Sub-micro Servos
- LiPo Battery
- Plastic gears
- Radio System (Tx + Rx)
- CF plates and rods
- Miscellaneous (tools, assembly equipment, adhesives, etc.)

C. Subsystems

- Flapping wing Subsystem
- Tail Subsystem
- Battery Subsystem
- Flight Control Subsystem
 - Tx & Rx
 - 3-Degree of freedom control (DOF)

D. Flapping mechanism design

The high carbon steel (HCS) step shaft is used for the intermediate gears. A pinion gear is fixed onto the shaft (side

with smaller diameter). From the other side the larger gear is fixed such that one of its sides touches the pinion. In the Fig. 4 and 5 CF refers to carbon fiber and GP refers to gear plate respectively.

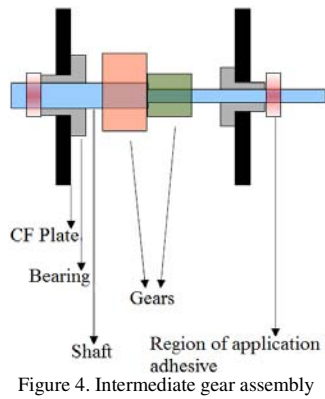

Figure 4. Intermediate gear assembly

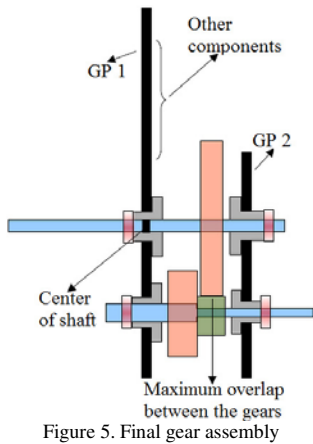

Figure 5. Final gear assembly

Fig. 6 shows the crank made up of high carbon steel. There are two holes in the crank, H1 and H2. H1 is slightly smaller than the outside diameter of the final shaft and H2 is of 3mm. A 3mm allen screw is placed in H2 as shown in Fig. 7.

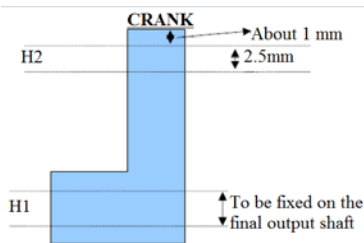

Figure 6. Crank

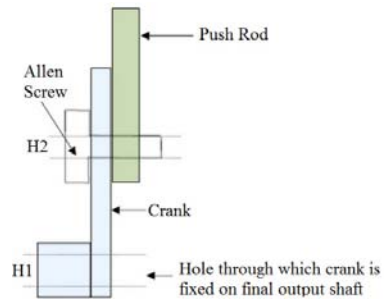

Figure 7. Linkage between crank and push rod

E. Wing

The wings are symmetrical about the longitudinal axis and their profile is shown in Fig. 8. The front hinge is rotated to 4-5° as shown. The wing hinges are made of ASTM 228 (standard spring wire). Fig. 9 shows the wing dimensions.

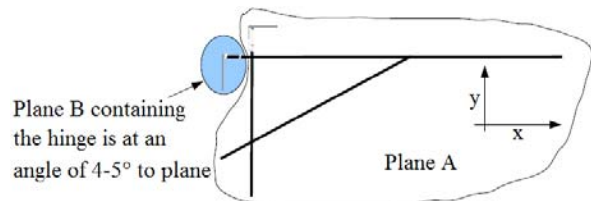

Figure 8. Wing profile

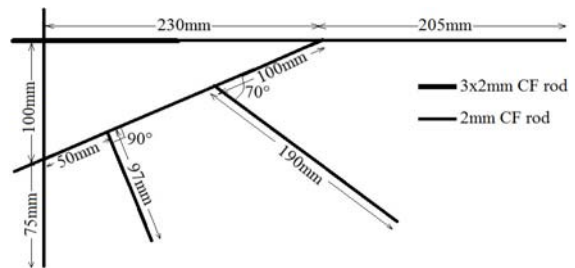

Figure 9. Dimensions of the wing

F. Tail Assembly

For the consideration of control sensitivity, the general style has been chosen and designed as shown in Fig. 10. The general style tail consists of horizontal and vertical tail.

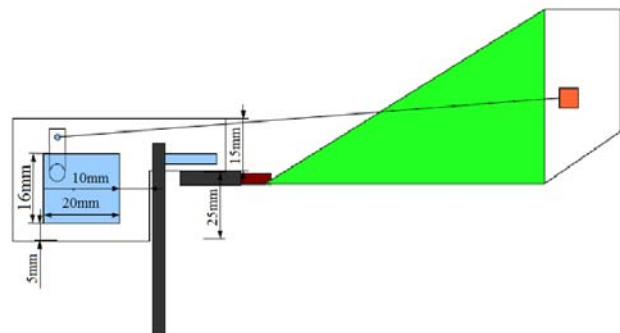

Figure 10. Tail

G. Connections

Fig. 11 shows the connections of the control system.

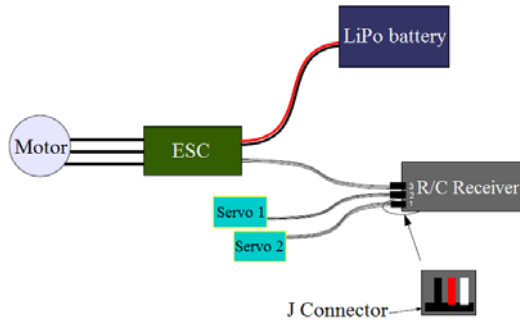

Figure 11. Connections

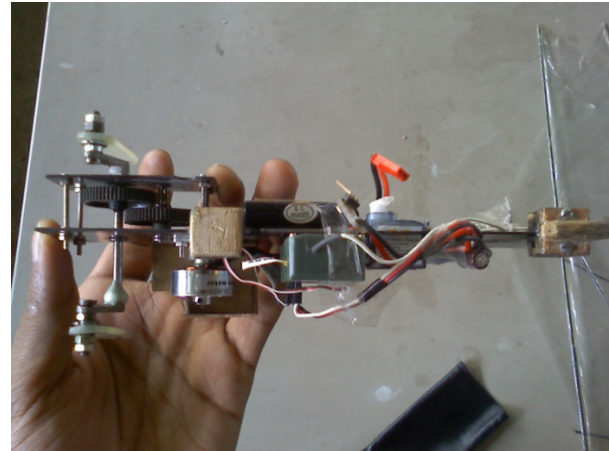

Figure 13. Fuselage with flight controls

H. Weight budget

The pie chart in Fig. 12 shows the weight distribution of the prototype. Here all the values shown are in grams. The gross weight of the prototype is 129g.

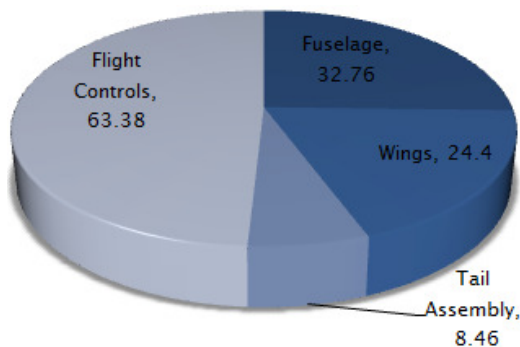

Figure 12. Weight distribution



Figure 14. Final prototype

I. Torque and power calculation

$$F_{Lift} = (0.129kg)9.8\frac{m}{s^2} \quad (1)$$

$$d_{Lift} = 0.06m \quad (2)$$

$$T = F_{Lift}d_{Lift} = 0.0758Nm \quad (3)$$

$$P = 2\pi Tf = 1.904W \quad (4)$$

Here 'F' denotes the lift force for level flight, 'd' is the distance between aerodynamic center and the longitudinal axis, 'T' stands for torque generated, 'P' for power and 'f' is the flapping frequency. Here no mechanical loss is assumed.

J. Prototype

The prototype consists of mechanisms of gear reduction, dc brushless motor, LiPo battery, ESC, receiver, sub-micro servos, CF chassis, fiber reinforced plastic (FRP) pushing rods, etc. According to the flapping mechanism, wing and tail design; the finally fabricated FWAV is as shown in Fig. 13 and 14.

III. ADVANTAGES

- Maneuverability
- Aerial reconnaissance
- Low noise signature
- Electric motors over IC engines
 - Better propulsive efficiency
 - More power
 - Quieter
 - More convenient

IV. APPLICATION

- Aerial photography
- Inspection of pollution
- Search for survivors
- Pipeline inspection
- High risk indoor inspection
- Silent and inconspicuous surveillance

V. CHALLENGES

The basic challenge involved in the development of FWAV is lack of thorough understanding of flow physics of very small A/C flying at low speeds and low Reynolds number. Also maintaining required AR is another important consideration.

VI. EXPERIMENTAL LAYOUT AND RESULTS

Some experiments were performed to optimize the flapping and wing design of AV. These are described here.

A. Wing Size

Several design stages were involved in designing the wing. The first set of triangular wings produced almost no thrust after we tried flapping them for the first time. Then the wing frame was redesigned. Further experiments were performed using this set of wings as they produced much more thrust.

B. Amplitude

The throw of the wing is decided by the distance between the holes drilled in the FRP pushrod. Several experiments were performed with different amplitude to determine the advantages of each one of them. It was deduced that the small amplitude provided fast flaps, but not sufficient thrust whereas the large amplitude provided slower but higher thrust flaps. Moreover with larger amplitude more jerky flapping motion is associated. Hence it was decided to settle on amplitude approximately in the middle of the range in which experiments were performed.

VII. CONCLUSION AND SUMMARY

The FWAV developed is capable of producing sufficient lift and thrust with onboard power supply and control electronics. The vehicle is operated by a single rotary actuator. It generates flapping pattern similar to that of birds. It was found that flapping wings provide more lift per unit span. Smaller wings can carry different payloads and can lift the same weight as compared to fixed wing aircraft.

ACKNOWLEDGMENT

Sincere thanks to Dr. K. V. Srinivasan [Sc 'G', ADE, DRDO], Dr. Ramesha C. [Associate Director, Student Welfare, Manipal Institute of Technology, Manipal University], Dr. Manohara Pai M. M. [CEO, MUTBI and Associate Director, Innovation Center, Manipal University], Dr. B. Ramamohan Pai [Professor and HOD, Dept. of Aeronautical and Automobile Engineering, Manipal Institute of Technology, Manipal University], Mr. Balbir Singh, Mr. Manikandan M. [Assistant Professor, Dept. of Aeronautical and Automobile Engineering, Manipal Institute of Technology, Manipal University], Mr. Mallela Srikant, Mr. Dega Rohit Reddy and Mr. Karthik Nadimpalli Venkata [Graduate Student, Indian Institute of Technology, Madras

(IIT-M)] for their constant unending support throughout the work.

REFERENCES

- [1] T. Nick Pornsin-Sirirak, Yu-Chong Tai, Chih-Ming Ho and Matt Keenon, "Microbat-A palm-sized electrically powered ornithopter," NASA/JPL Workshop on Biomimetic Robotics, Pasadena, CA, August 14-17, 2001.
- [2] de Croon G.C.H.E., de Clercq K.M.E., Ruijsink R., Remes B. and de Wagter C., "Design, aerodynamics, and vision-based control of the Delfly," International Journal of Micro Air Vehicles, vol. 1, number 2, pp. 71 – 97, 2009.
- [3] Michael. A. A. Fenelon, "Biomimetic flapping wing aerial vehicle," IEEE International Conference on Robotics and Biomimetics, Bangkok, Thailand, February 21-26, 2009.
- [4] R.S. Fearing, K.H. Chiang, M. Pick Dickinson, M. D.L. Sitti, and J. Yan, "Wing transmission for a micromechanical flying insect," IEEE International Conference on Robotics and Automation, San Francisco, CA, pp. 1509-1516., 2000.
- [5] S.H. McIntosh, Z.A. Khan and S.K. Agrawal, "Design of a mechanism for biaxial rotation of a wing for a hovering vehicle," IEEE/ASME Transactions on Mechatronics, vol. 11, No. 2, pp. 145-153., 2006.
- [6] C. Galinski and R. Zbikowski, "Insect-like flapping wing mechanism based on a double spherical scotch yoke," Journal of the Royal Society: Interface, vol. 2, no. 3, pp. 223-235, 2005.
- [7] R. Zbikowski, C. Galinski, and C. B. Pedersen, "Fourbar linkage mechanism for insect-like flapping wings in hover: Concept and an outline of its realisation," Transactions of the ASME: Journal of Mechanical Design, vol. 127, no. 4, pp. 817-824, 2005.
- [8] Michael. A. A. Fenelon, Tomonari Furukawa, "Design of an active flapping wing mechanism and a micro aerial vehicle using a rotary actuator," Mechanism and Machine Theory, vol. 45, issue 2, pp. 137-146, 2010.
- [9] R. Madangopal, Z.A. Khan, S.K. Agrawal, "Biologically inspired design of small flapping wing air vehicles using four bar mechanisms and quasi steady aerodynamics", Journal of Mechanical Design, vol. 127, pp. 809-816, July 2005.
- [10] P.G. Ifju, A. D. Jenkins, S. Ettingers, Y. Lian and W. Shyy, "Flexible-wing-based micro air vehicles," AIAA Paper 2002-0705, 2002.
- [11] <http://www.proxflyer.com>
- [12] K.D. Jones, C. M. Dohring and F. M. Platzer, "Experimental and computational investigation of the Knoller-Betz effect," AIAA Journal 36, 1240-6, 1998.
- [13] Y. Kawamura, S. Souda and C. P. Ellington, "Quasi-hovering flight of a flapping MAV with large angle of attack," The Third International Symposium on Aero Aqua Bio-Mechanisms, Okinawa Convention Center, Ginowan, Okinawa, Japan, 2006.
- [14] Wei Shyy, Yongsheng Lian, Jian Tang, Dragos Vieru and Hao Liu., Aerodynamics of low Reynolds number flyers, Kinder edition, Cambridge Aerospace Series, 2007, Chapter 1.
- [15] Zaeem A. Khan and Sunil K. Agrawal, "Design and optimization of a biologically inspired flapping mechanism for flapping wing micro air vehicles," IEEE International Conference on Robotics and Automation, Roma, Italy, April 10-14, 2007.
- [16] S. Dhawan, "Bird flight," Sadhana – Academy Proceedings in Engineering Sciences 16, 275-352, 1991.
- [17] J. B. Anders, "Biomimetic flow control," AIAA Paper 2000-2543, 2000.
- [18] <http://my.fit.edu/~dkirk/4291/Team%20Page/Mid%20Term%20Presentations/MAV%20Juggernaut.ppt>