

Development of Multi-Movement Mobile Robot

[Abd Kadir Mahamad, Sharifah Saon, and Jayne Juking]

Abstract— This project involves the design and development of an autonomous mobile robot that can move in various motions using Mecanum wheels. The Mecanum wheels developed consist of fifteen rollers made from abacus beads. All Mecanum wheels are independently powered using four units of DC motors and gearbox system. The aim of this project is to build a robot, which is autonomous, and move according to what have been programmed. The functions are forward, reverse, right slide, left slide, diagonal, rotation and obstacles avoidance. All these functions are set up by using MPLAB IDE software. This robot is controlled by microcontroller PIC16F877A which use as the brain to control the robot movement. This robot has obstacles avoidance capability which the robot will avoid obstacles like walls and boxes. It is equipped with three IR sensors on the left, right and in front of the robot to detect any obstacles.

Keywords—Autonomous Mobile Robot, Mecanum wheels, PIC16F877A.

I. Introduction

Multi-Movement Mobile Robot using Mecanum Wheels is an autonomous robot using four custom-made Mecanum wheels, which provide multi directional movement without needing a conventional steering system. The Mecanum wheels are built by using fifteen rollers made from abacus beads. The Mecanum wheels are also independently powered using four units of precision gear DC motors and the wheels assemblies were mounted directly to the robot chassis which is made from Perspex. This robot is controlled by a microcontroller type PIC16F877A as a brain of robots and supported by integrated circuit as a driver and other electronic components. Finally, the robot is equipped with three unit infrared sensors (IR) to detect obstacles.

In recent years, current mobile robot use conventional wheels to move. One of the requirements of an autonomous mobile robot is its ability to move through the working space, avoiding obstacles and finding its way to the next location, in order to perform its task. In order to know the destination, the robot must have accurate knowledge of its current location. It means it should use several sensors in order to move in tight areas and avoid obstacles. These capabilities mainly depend on the wheel design. Mecanum wheels are sometimes employed in vehicles in order to solve the problem. Using four Mecanum wheels, multi directional movement can be accomplished for a vehicle without needing a conventional steering system. Because of its mobility, it will have many applications either in home, industrial or other area.

II. Literature Review

A. Mecanum Robot

The utilization of the Mecanum wheel in the robot design was pioneered in 1973 by Mecanum AB's Bengt Ilon. Mecanum wheel is allowing the principle of a central wheel with a number of rollers placed at an angled around the periphery of the wheel. The angled peripheral roller transforms a portion of the force in the rotational direction of the wheel to produce force normal to the wheel directional. For each individual wheel direction and speed, the output combination of all these forces generate a total force vector in any desired direction as a result allowing the platform to move freely in direction of resulting force vector, without varying the direction of the wheel. Fig. 1 shows a traditional Mecanum wheel design by Ilon with the peripheral roller with 45° degree slope held in place from the outside. Using four Mecanum wheels provides multi directional movement for a vehicle without needing a conventional steering system [1].

Throughout the literature review [1]-[3], it shows that special wheel designs are based on a concept that achieves traction in one direction and permit passive motion to another, consequently allowing greater flexibility in heaving environments. Currently, used designs are based on Ilon's original concept. Most of the omni-wheel robots consist of a triangular and three wheels [2][3]. With a three-wheel design, it is impossible to get 100% efficiency from its wheels. But with four-wheel, two wheels can move at 100% efficiency, meanwhile the other two remain idle. The design of this project also cheaper because all the Mecanum wheels are made from plastic modified abacus beads and the chassis is made from Perspex.

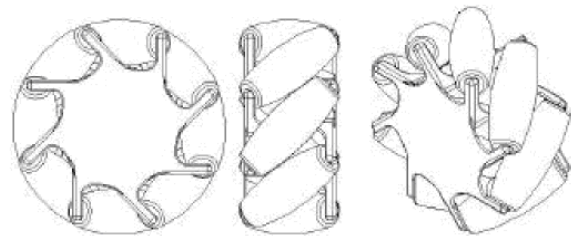

Figure 1. Mecanum wheel based on Ilon's concept

III. Methodology

A. Robot Development

Fig. 2 shows the steps taken to develop the Multi-Movement Mobile Robot using Mecanum Wheels. The first step is to design the main circuit of this project. The circuit is designed by using Proteus software. Later the software part is started whereby the assembly language is written in MPLAB IDE software. The next step is to design and implement mechanical structure of the mobile robot base. The design includes the base, Mecanum wheels and the DC geared motor. Continuous adaptation and improvement will be made alongside the step. The following step is the most important stage which is the integration between the hardware and software. The validity and feasibility of the programs codes are tested and evaluated by trial-and-error method. Finally, the system is upgraded and improved to better the overall performance of this project.

B. Hardware Design

The main chassis of the robot is made from Perspex. This transparent plastic board has been chosen as the chassis because it is light and easy to cut. The Mecanum robot is designed based on two-layer structure as shown in Fig. 3. At the bottom layer, the motors and gearboxes are placed at the rear and front of the chassis. The left and right motors are controlled separately. The IR sensors will be placed in the middle layer. This is to ensure the sensors will give a good result when detecting the obstacle. The top layer mainly contains the electronic circuitry and the microcontroller. The major components in this project are DC motor [4], gearbox, Mecanum wheel, IR sensor, motor driver (L293D) and PIC16F877A [5].

C. Mecanum Wheel

The Mecanum wheels developed in this project consist of fifteen rollers. All rollers are made from plastic modified form abacus beads. The roller was hold by roller holder made by stainless steel (bolt and nut) and each holder has three rollers. Fig. 4 shows the components used to develop the Mecanum wheels. All Mecanum wheels are independently powered using four units of precision gear DC motor and the wheel assemblies were mounted directly to the robot chassis.

D. Circuit Design

This project uses PIC16F877A as the main controlling and DC geared motor to drive the Mecanum wheels individually. As the input, IR sensors and mode switches are used. To control the DC geared motor, motor driver L293D is used. Fig. 5 shows the completed circuit design of the Multi-Movement Mobile Robot using Mecanum Wheels.

E. Microcontroller

Microcontroller plays a very important role in controlling the robot's movement [5]. After some in depth studies and survey, and taking into consideration its suitability and the project's requirement, it is discovered that Microchip PIC16F877A will be the most suitable choice for this project. Table 1 show an input and output connection to the microcontroller.

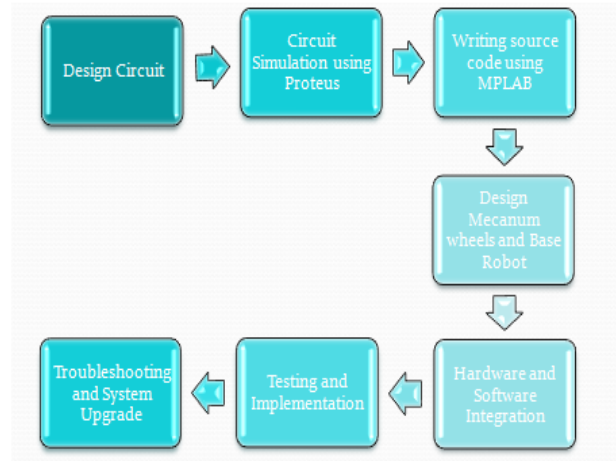

Figure 2. Flow of methodology

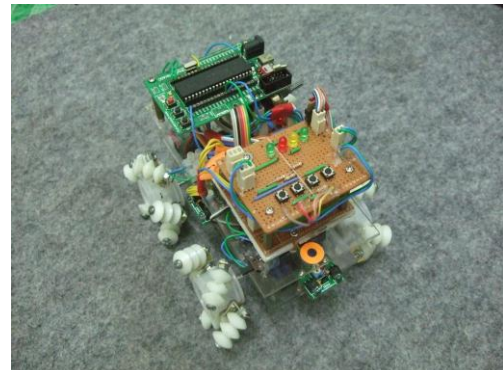

Figure 3. Multi-Movement Mobile Robot using Mecanum Wheels

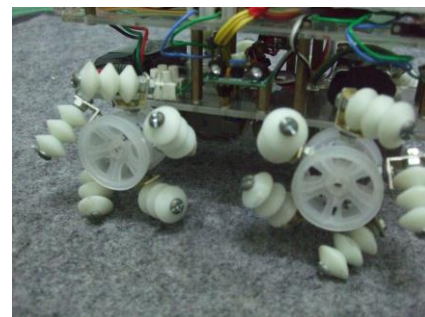

Figure 4. Mecanum Wheels using Abacus Beads

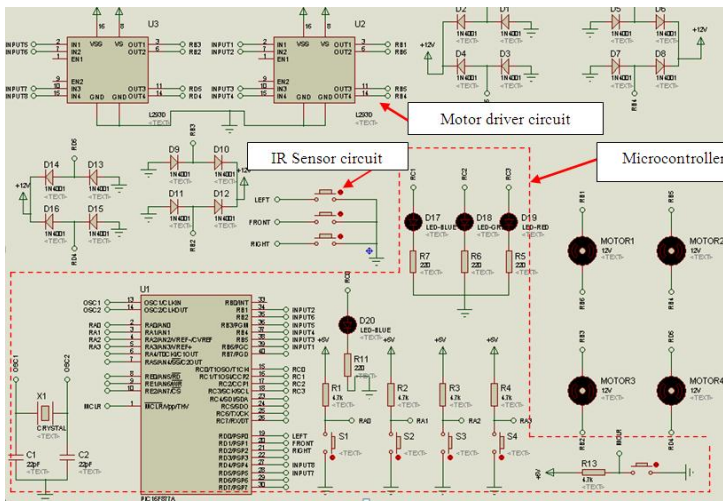

Figure 5. Circuit design of the Multi-Movement Mobile Robot using Mecanum Wheels

TABLE 1. INPUT/OUTPUT CONNECTION TO THE MICROCONTROLLER

Port Microcontroller	Input/output
RB4 and RB3	Motor 1
RB2 and RB1	Motor 2
RD7 and RD6	Motor 3
RD5 and RD4	Motor 4
RD0	Left Sensor
RD1	Front Sensor
RD2	Right Sensor
RA0	Switch 1 (Autonomous)
RA1	Switch 2 (Slide)
RA2	Switch 3 ((Diagonal)
RA3	Switch 4 (Rotational)
RC0	LED1 (Autonomous)
RC1	LED2 (Slide)
RC2	LED3 ((Diagonal)
RC3	LED4 (Rotational)

F. Software Design

The programming design of the robot is to control its movement in multi directional. The algorithm applied is in the type of flow chart as shown in Fig. 6 and 7. The Assembly Language Programming is used to program the PIC16F877A by using MPLAB Integrated Development Environment (IDE) software. This robot has four switches and it has different modes. The first mode is for autonomous mode that can move everywhere automatically and it able to avoid obstacles. Obstacle will detect by IR sensor and the robot will move to another way. There are three special movement of the Mecanum robot. The special movement of the Mecanum robot are slide movement, rotational movement and diagonal movement.

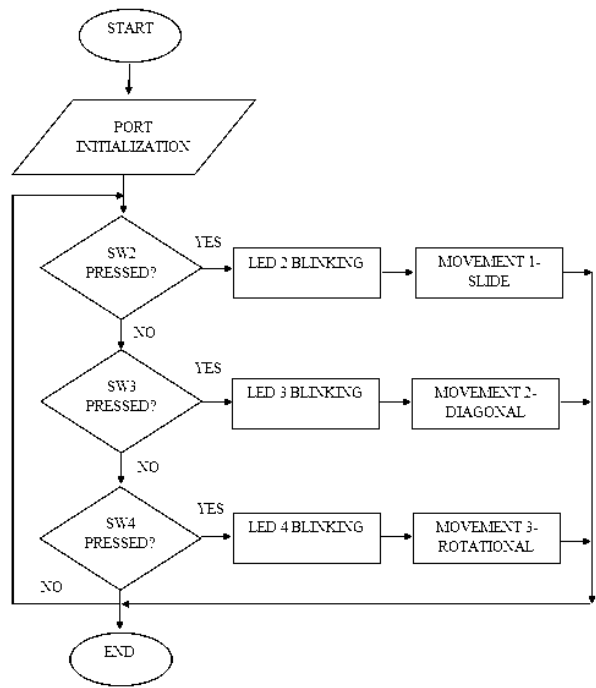

Figure 6. Flowchart for special movement mode

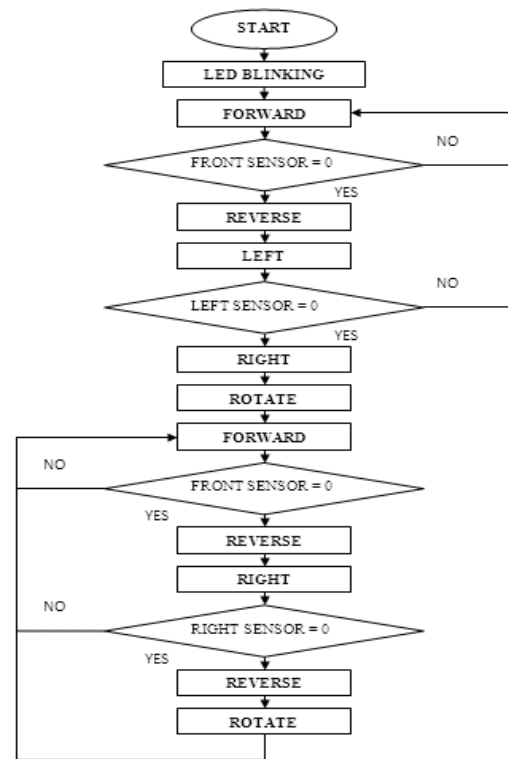

Figure 7. Flowchart for autonomous mode

IV. Result and Analysis

A. The Characteristic of Multi Movement Mobile Robot using Mecanum Wheels

The first step in the analysis process is to identify the characteristic of the robot. Analysis conducted based on the primary objectives of this project, which is to design and construct a mobile robot that can move in multi-directions such as forward, slide left, slide right, reverse, diagonal, rotation using Mecanum wheels and manage to avoid obstacles. A set of algorithm for every movement needs to be set at the beginning. The subroutine for the program is written based on the algorithm. This analysis was conducted based on the secondary objectives of this project which is to develop the software to be programmed into the microcontroller which going to control the movement of the mobile robot. The analysis process is then carried out based on the third objectives which is to examine the robot can move smoothly and stable to achieve successful and reliable multi-directional mobile robot using Mecanum wheels based on the ordinary mobile robot as in Table 2.

B. Robot's Abilities

Once the robot characteristics have been identified, the next step is to analysis and to identify the strengths and weaknesses of robot. Robot is tested by moving it on flat surface, sandy surface, grass surface and grumble surface tests the robot. From experiments conducted, robot was able to move perfectly on flat, sandy and grumbled surfaces. However, difficulties occurred when the robot tried to move on grassed surface and slippery floor. The robot was still able to move, but the direction will be missed. Fig. 8 shows the results of the robot movement.

TABLE 2. MECANUM WHEELS MOVEMENT ON DIFFERENT SURFACE MEASUREMENT

Movement	Duration (s)	Smooth Surface Distance (cm)	Rough Surface Distance (cm)
Forward	5	33	27
Reverse	5	33	26
Right Slide	3	22	19
Left Slide	3	22	17
Right Diagonal	5	18	10
Left Diagonal	5	18	10
Rotational clockwise	1.5	180 degree	150 degree
Rotational anti-clockwise	1.5	180 degree	150 degree

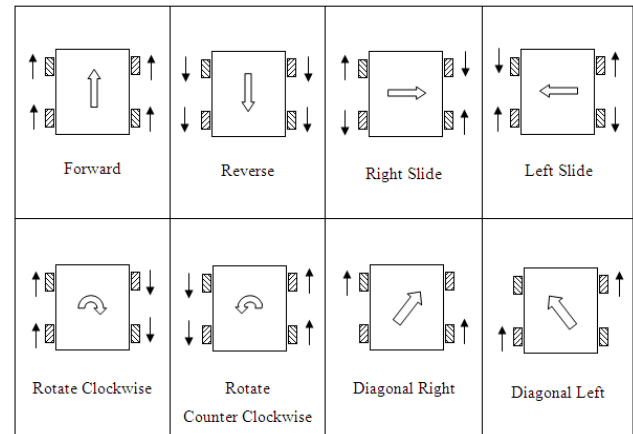

Figure 8. Multi movement of Mecanum robot

V. Conclusion

This paper discusses about the development of Multi Movement Mobile Robot using Mecanum Wheels actuated by four separated DC motors and gearbox system. This project is implemented using PIC16F877A, which was programmed using the assembly language to control the robot. The robot was successfully built and tested as specified by the objective. Through the development of the project, many skills have been acquired. The skills are designing mechanical structure, circuit design and interfacing hardware and software in computer. As a conclusion, this project is successfully designed, implemented and tested. Hopefully this robot can be reconstructed with some modification to improve the abilities and to provide benefits in future.

Acknowledgment

The financial support received from the Exploratory Research Grant Scheme (ERGS), (Vot No: E036), Office for Research, Innovation, Commercialization and Consultancy Management (ORICC), University Tun Hussein Onn Malaysia is gratefully acknowledged.

References

- [1] Olaf Diegal, Apama Badve, Johan Potgieter, Sylvester Tiale (2002). *Improved Mecanum Wheel for Omni-directional Robots*. Massey University, Auckland.
- [2] Jefri Efendi Mohd Salih, Mohamed Rizon, Sazali Yaacob, Abdul Hamid Adom and Mohd Rozailan Mamat (2006). *Designing Omni-Directional Mobile Robot with Mecanum Wheel*. Kolej Universiti Kejuruteraan Utara Malaysia.
- [3] Hasril Izham B. Ismail @ Abu Hassan (2011). *Omni Directional Line Following Mobile Robot*. Universiti Teknologi Malaysia: Thesis B. Electrical Engineering (Mechatronics).
- [4] Mabuchi FA-130 Datasheet, 2010
- [5] PIC16F877A Microcontroller User Manual, 2010

About Author (s):



Abd Kadir Mahamad received his B.E. and M.S. in Electrical Engineering from Universiti Tun Hussein Onn, Malaysia and PhD in Electrical Engineering from Kumamoto University, Japan. He is currently a Senior Lecturer at Faculty of Electrical and Electronic Engineering, Universiti Tun Hussein Onn Malaysia. His research interests include intelligent systems application, fault diagnosis and prognosis especially for electrical rotating machinery.



Sharifah Saon received her B.E. and M.S. in Electrical Engineering from Universiti Tun Hussein Onn, Malaysia. She is currently a Lecturer at Faculty of Electrical and Electronic Engineering, Universiti Tun Hussein Onn Malaysia. Her research interests mainly on signal processing.



Jayne Juking received her B.E in Electrical Engineering from Universiti Tun Hussein Onn, Malaysia. She is currently an engineer at Sabah Electricity Sdn Bhd, Malaysia.