

Design and fabrication of a high power S band LDMOS amplifier for microwave power transmission and wireless communication

Doan Huu Chuc, Bach Gia Duong

Abstract—In this paper, we introduce an overview of wireless power transmission for Solar Power Satellite. Specially, We present the study, design and fabrication of a 355W multi stage S – band solid – state power amplifier to be used for Solar Power Satellite. The power amplifier module with 45W peak output power is used as the basic cell of the amplification. Combining 8 of these modules, we achieve 355W. The design and simulated results were carried out by the microwave engineering professional design software, known as ADS2009 package. All simulations and experimental results will be reported.

Keywords— *microwave power transmission, power amplifier, wilkinson divider/combiner.*

I. Introduction

Wireless power transmission (WPT) can be subdivided into either near-field inductive-based WPT or far-field WPT. MPT comprises the microwave-frequency based subset of far-field WPT. In an MPT scenario, significant amounts of power are transferred from one location to another. MPT research has been driven primarily by the desire to remotely power unmanned aerial vehicles (UAVs) and by the concept of space solar power (SSP) first conceived by Dr. Peter Glaser of the Arthur D. Little Company in 1968. Most MPT breakthroughs have occurred under the umbrella of SSP. The SSP idea calls for a constellation of solar power satellites (SPSs) to be placed in geosynchronous orbit (36 800 km above Earth) in order to capture the sun's energy using arrays of solar cells. The satellites, each measuring several miles across, would be located in geo to keep them in view of the sun 99% of the time. This sun exposure is twice that of terrestrial solar cells. This means that power can be readily generated and distributed at night, especially during the evening hours when power consumption peaks. This is of particular importance given that power storage still has severe limitations. In addition, the closer the satellites are placed to the sun, the larger their effective collection area is, since light intensity decreases by the inverse square of distance [1].

Solar Power Satellite is a concept to collect solar power in space and then transport it to the surface by microwave beam, where it is converted into electrical power for terrestrial use. The SPS systems are considered one of the most promising

renewable energy sources. Since the solar power density in the side of the earthfacing the sun is 1.37 KW/m², which is almost stable, an area of 4 km² receives 5.5 million KW of solar power. Supposing a 50% solar-cell efficiency from solar power to DC, a 70% microwave power amplifier efficiency from DC to microwave power, and a 70% rectenna efficiency from microwave power to DC power, the total power transmission efficiency is roughly estimated to be 25%. This value makes a 1 million–KW-class power plant feasible, which is almost equivalent to a single nuclear power plant [2,3].

We need more efficient and higher quality and more economical MPT system for the SPS. Block diagram of the MPT system is shown in Figure 1. However, there was no commercial MPT system and there were only some elemental and experimental MPT systems in the world. There are some reasons. One is frequency regulation problem. The other is shortage of effective and economical MPT applications. The SPS is expected to realize around 2030. Before the realization of the SPS, we can consider the other application of the MPT. The potential applications of the MPT include charging of mobile phones and laptops, radio-frequency identification (RFID), electrically charged vehicles, biomedical sensors, etc.

The transmitter of the MPT system is especially important. It could be seen as the key to successful implementation of the MPT system. The block diagram of the transmitter unit used for MPT is shown in Figure 2. In the case, high power and efficient power amplifiers are requested. Regarding applications of the high power microwave, the use of semiconductor high power amplifiers is extended in the field of energy. Recently, semiconductor devices as a main high power amplifier are widely used beyond the S-band. Solid-state power amplifiers (SSPAs) have many advantages over microwave tubes including availability, reliability, graceful degradation and ease of maintenance. Solid-state amplifiers are also capable of operating by low voltage power supplies, suppressing need for high voltage modulators and eliminating possible X-ray emission [4,5].

In this paper, we present the design and fabrication of the 45W S band SSPA over range of 2.4 GHz to 2.7 GHz and 8 – way divider/combiner for microwave power transmission, as well as for wireless communication. Further, the structure and design method of the 355W – class power combiner unit with power amplifier will be described.

Doan Huu Chuc
Hai Phong Private University
Vietnam

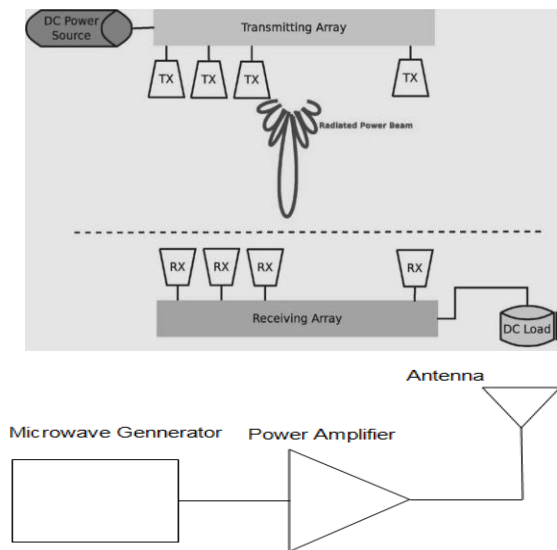

Figure 1. The block diagram of transmitter unit of Wireless power transmission system.

II. General block diagram of the amplifier

The SSPA high power equipment was operated at 2.4GHz – 2.7GHz band and consists of three parts, a driver amplifier, 45W-class power amplifier units and a Wilkinson combiner. The block diagram of the proposed SSPA is shown in Figure 3.

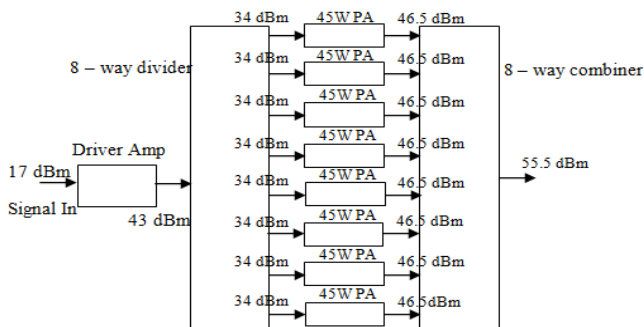

Figure 2. Block diagram of the proposed SSPA.

The input signal of the SSPA is a CW RF signal with the frequency between 2.4GHz to 2.7GHz and 17dBm. This signal is fed to the input port of the Driver Amplifier (Driver Amp). The first block of the Driver is a amplifier, which has output power 1W as described in Figure 4. The second stage amplifies the RF signal up to 20W. This signal is fed to the input port of the 8 – way Wilkinson divider. The divider splits RF signal into eight in phase, equal power signals. Each of the outputs has 34dBm, enough to drive an PA. The next phase, there are eight 45W amplifier modules, same as the power amplifier module at the second stage of the Driver Amp. Finally, a 8:1combiner combines the outputs of

amplifiers and produces a 355W signal at the output of the combiner. All of the 45W power amplifier modules used in the Driver Amp and PAs are identical. Also all of the 8:1 combiners and 1:8 divider have similar structures.

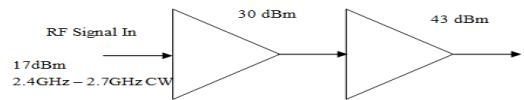

Figure 3. Block diagram of the Driver Amp.

III. Design and fabrication of the amplifier

A single-stage microwave transistor amplifier can be modeled by the circuit of Figure 5, where matching networks are used on both sides of the transistor to transform the input and output impedance Z_0 to the source and load impedances Z_S and Z_L . In the microwave field, standard circuit theory generally cannot be used directly to solve microwave network problems. In a sense, standard circuit theory is an approximation or special use of broader theory of electromagnetics as described by Maxwell's equations [6]. This means that the procedure for microwave design absolutely differs from the one at lower frequencies. This is so-called impedance matching technique. In general, there are many based-on-Smith-chart matching approaches introduced in detail in [6] such as, lumped matching network, micro-strip matching network, etc. The advantages of CAD software supported by Agilent Technology make it easier to design, optimize, and lower the cost. Maximum gain will be realized when the input and output matching section provide a conjugate match between the amplifier source or load impedance and the transistor [6,7].

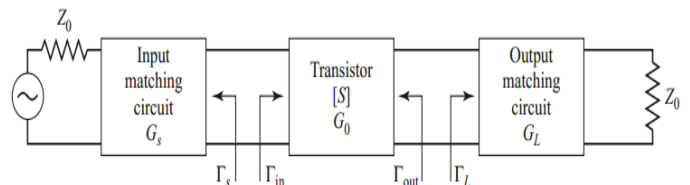

Figure 4. The general transistor amplifier circuit.

In this paper, the high power PTF240451E was selected to design and fabrication the power amplifier module to be used for microwave power transmission system. This is a 45W LDMOS FET power amplifier operating frequency ranging from 2.4GHz to 2.5GHz. All design and simulations are carried out by the microwave engineering professional design software, known as ADS2009 package.

The schematic of the power amplifier is shown in Figure 6. As shown in Figure 6, the two port network is applicable in design consisting of the input impedance matching, output impedance matching and DC biasing. DC power is supplied across quarter wavelength transmission line not to make interference the AC signals.

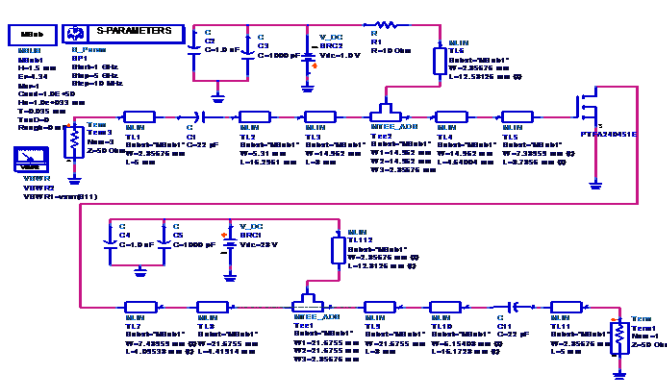

Figure 5. Schematic of the power amplifier.

The circuit is simulated in double-sided FR4 (Dielectric constant =4.34, Height =1.6mm, Thickness =0.035mm) and power supply 28VDC. Aftermaths, the layout of the circuit is designed and fabricated using the LPKF protomat C40 in Figure 7. The amplifier has a size of 12mm × 6mm. It is then made a test using the Vector Network Analyzer 37369D (40MHz – 40GHz). This step will help the designer analyze or even directly optimize the design. Another problem must be paid attention is that cooling for power transistor to guarantee the operating condition. In this design, it could be seen in Figure 7. Such an amplifier is working at 28VDC @500mA, class AB.

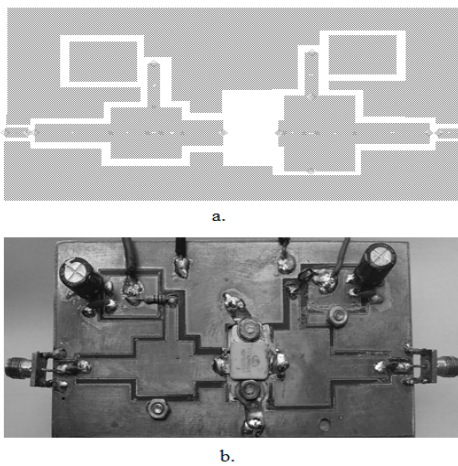

Figure 6. a. Layout of the power amplifier; b. The fabrication of the amplifier.

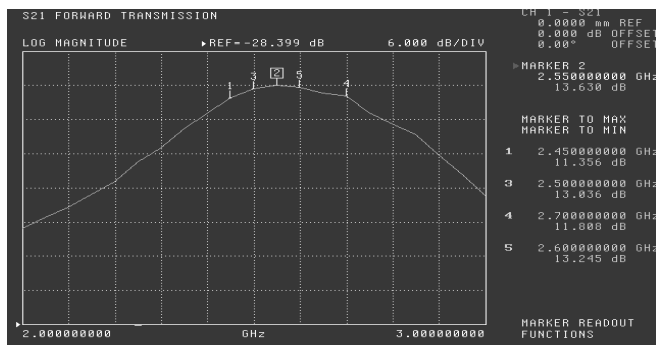

Figure 7. The amplitude of S21 in dB of the amplifier.

The value of S21 (gain of the power amplifier) is shown in Figure 7. The measured S21 is over 11dB operating at 2.4GHz -2.7GHz band. The gain of the amplifier is achieved peak gain 13.6dB at 2.5GHz. This is very well in comparison with the ideal value of PTFA240451E. The Figure 8 illustrates that the result of S12 is less than -30dB at 2.4 GHz – 2.7GHz band. Correspondingly, the power amplifier has high – isolator characteristic, which mean that the power amplifier can be achieved maximum gain. The input return loss is smaller 5dB for input matching requirement of the power amplifier as shown in Figure 9. The value of S11 is achieved -8.2dB at 2.5GHz, which means that the impedance matching is fairly well matching to 50Ω. The output return loss of the power amplifier is shown in Figure 10. The figure tells you that the S22 reaches to -25dB at 2.5GHz. Therefore, the output impedance matching is very good.

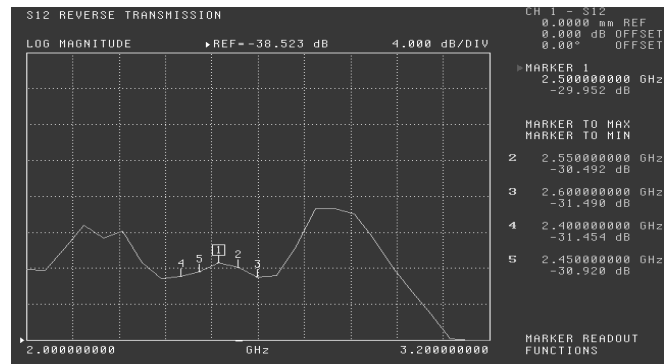

Figure 8. The measurement result of S12.

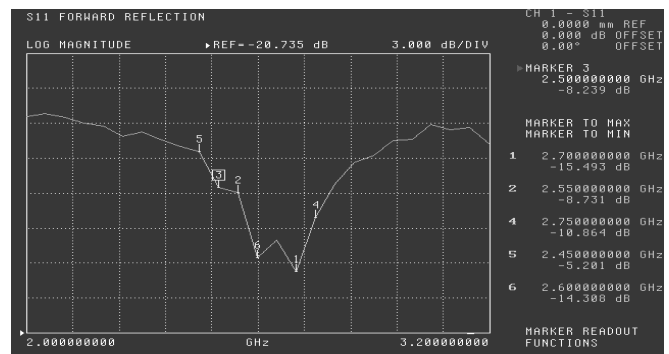

Figure 9. The value of S11.

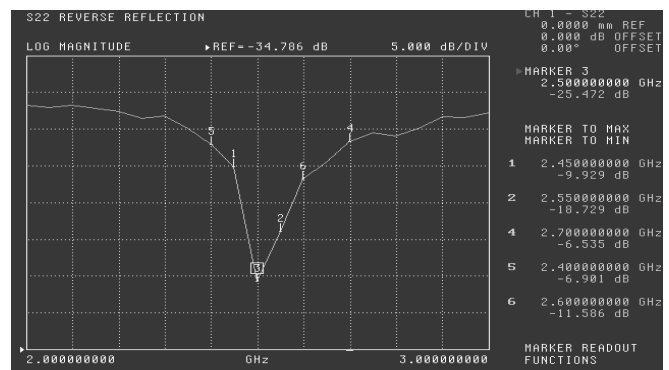

Figure 10. The value of S22.

According to the above results, the presented amplifier could absolutely satisfy the parameter in terms of a power amplifier.

iv. 8- way Wilkinson dividers and combiners

Since power combiner/dividers are reciprocal networks, a single design has been used for all of the 8:1 combiners and 1:8 dividers in the proposed SSPA. These combiners and dividers are the 1:8 divider at the output of the Driver Amp and combiner at the output of the SSPA. There are many types of N-way combiner/dividers that could be used as 8:1 combiner/divider, each of them having some benefits and some drawbacks. In this design for achieving high isolation between input ports and keeping the structure of design planar, cascade arrangement of 2:1 Wilkinson combiner/divider cells was used for implementation of the 8:1 combiner/divider.

The 2-way Wilkinson Power Divider (WPD) usually employs quarter-wavelength transmission line $\lambda/4$ section at the design center frequency and Wilkinson power consists of two quarter -wavelength line segments at the center frequency with characteristic impedance $\sqrt{2} * Z_0$, and a $2 * Z_0$ lumped resistor connected between the output ports. A popular basic configuration of the 2-way WPD is often made in micro-strip or strip-line form as depicted in Figure 11.a, and the corresponding transmission line circuit is given in Figure 11.b [8-10].

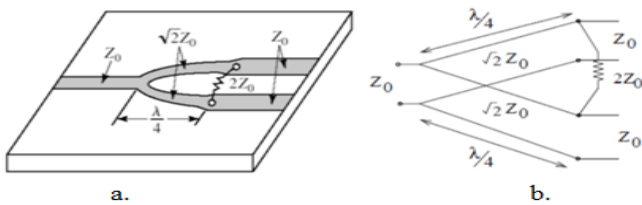

Figure 11. a. An equal-split WPD in microstrip form; b. Equivalent transmission line circuit.

In this part, a 8-way Wilkinson power divider with a center frequency of 2.45 GHz matched to 50-Ω transmission line was designed and fabricated. Schematic of 8 – way WPD is shown in Figure 12. The circuit was designed and optimized using Advance Design System (ADS), then fabricated using micro-strip lines with a FR4 substrate. The circuit was later observed with the Anritsu 37369D Vector Network Analyzer, and these experimental results were compared with the ADS simulation.

In the Figure 13, it could be figured out that the transmission coefficient is good matching being less than -64 dB over the center frequency. The simulated transmission coefficient's attenuation is equal to -9.03dB, being nearly close to the theoretical one. The achieved results totally satisfy the given criteria about loss, bandwidth, VSWR, and 50Ω matching requirement.

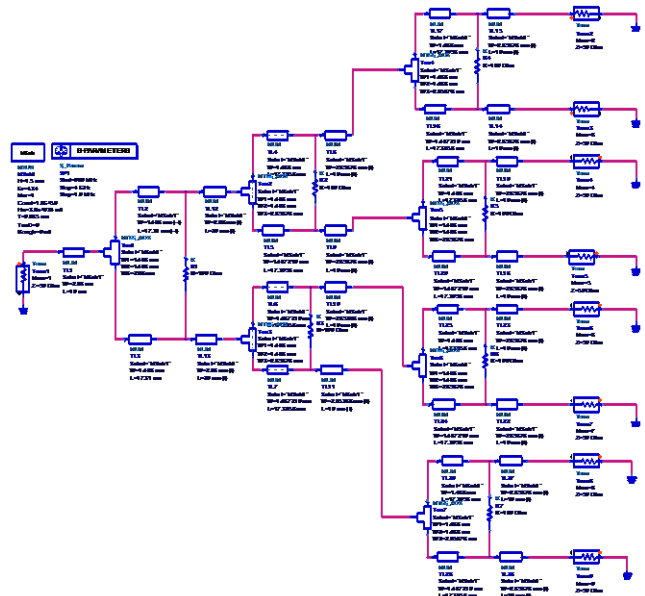

Figure 12. Schematic of 8 – way WPD.

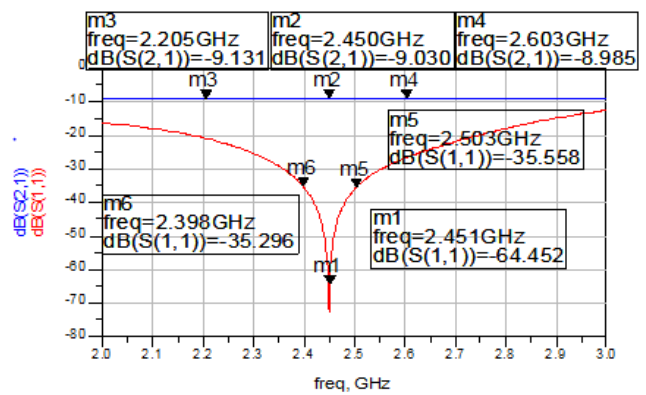

Figure 13. The simulated results.

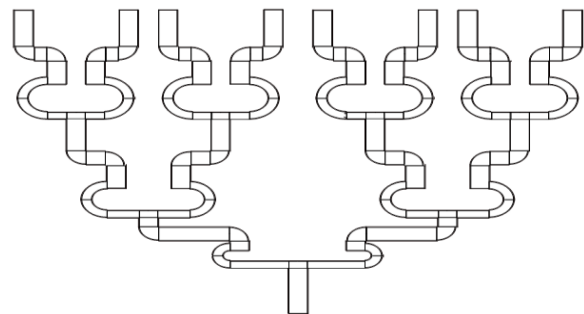

Figure 14. Layout of 8- way WPD.

The measured values S_{21} and S_{11} of Wilkinson power divider are given in Figure 15 and Figure 16, respectively. According to $S_{21} = -9$ dB in the range of 2.4 GHz to 2.5 GHz band, which is better than results with values obtained in the

simulation. Moreover, the value of S11 is less than -12 dB at 2.45 GHz frequency, which means that being fairly well matching to 50Ω.

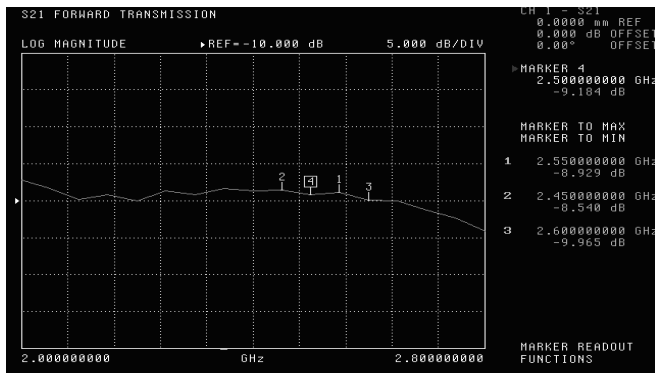

Figure 15. The experimental transmission coefficient.

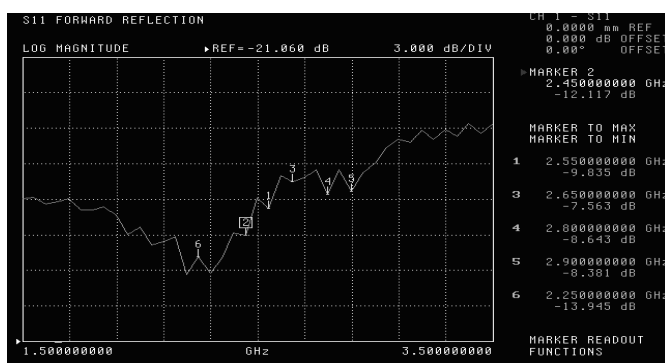

Figure 16. The value of S11 on the Network Analyzer.

The driver amplifier is used to amplify the input RF signal before being feeding into the Wilkinson power divider. Output ports of WPD are amplified by next PA modules as described in Figure 3. The gain of power amplifier module is over 11 dB operating at 2.4 GHz – 2.7GHz band. Other parameters are met for a signal generator circuit for in proposed configuration.

v. Conclusion

We have successfully designed and fabricated the power amplifier using 45 watt LDMOS FET and the 8 – way Wilkinson divider/combiner at a frequency band of 2.4GHz – 2.7GHz. In addition, combining 8 of power amplifier modules allows the output to be up to 355W. This technology can be applied to the high power amplifier in the power transmitter of the microwave power transmission and the wireless communication. Also, the research will be the breakthrough for the design of microwave power transmission system especially in Vietnam.

References

[1] Bernd Strassner and Kai Chang, “Microwave Power Transmission: Historical Milestones and System Components”, Proc. of the IEEE, pp. 1379-1396 Vol.101, No.6, June 2013.
 [2] S Sheik Mohammed, K Ramasamy and T Shanmuganatham, Wireless Power Transmission: A Next Generation Power Transmission for Solar

Power Satellite, International Journal of Computer Applications, pp. 100-103, February 2010.

[3] N. Shinohara, S. Kawasaki, “Recent Wireless Power Transmission Technologies in Japan for Space Solar Power Station/Satellite,” Proc. RWS’09, pp. 13-15, San Diego, US, January 2009.
 [4] H. Noji, Y. Shibuya, K. Isono, M. Hori, Y Kobayashi, T. Ishizaki, S. Furuta, Y. Moriguchi, Z. Yamamoto and S. Kawasaki, “A 1kW – class S – band compact waveguide combiner unit with GaN HPAs for WPT and space communication,” Proc. 41 st European Microwave Conference, Manchester, UK, pp. 234 -237, October 2011.
 [5] S Reza Motahari, H Pahlevaninezhad, D Shekari Beyragh, “Design and implementation of a high power S –band solid –state pulsed amplifier for LINAC,” Proc. of International Symposium on Signals, Systems and Electronics, Nanjing, China, pp.1-4, September 2010.
 [6] David M.Pozar, Microwave Engineering, John Wiley & Son, INC, 4th Edition, US, 2012.
 [7] I Boshnakov, A Wood, S Taylor, “RF and microwave solid-state power amplifiers design is a speciality,” Proc. of the Automated Radio Frequency and Microwave Measurement Society Conference, Oxfordshire, UK, April 2012.
 [8] E. J. Wilkinson, An N-way hybrid power divider, IRE Trans. Microwave Theory Tech., pp. 116-118, vol. MTT-8, 1960.
 [9] A. Wentzel, V. Subramanian, A. Sayed, and G. Boeck, Novel Broadband Wilkinson Power Combiner, Proc. 36th European Microwave Conference, Manchester, UK, pp. 212-215, September 2006.
 [10] Taufiqurrachman, Deni Permuna Kurniadi, Design and Realization Wilkinson Power Divider at Frequency 2400MHz for Radar S-Band, IOSR Journal of Electronics and Communication Engineering (IOSR-JECE), pp. 26 - 30, Volume 3, Issue 6, December 2012.



Doan Huu Chuc received the B.S. and M.S. degrees in engineering electronics from the Vietnam National University (VNU), Hanoi in 2000 and 2007, respectively. He is currently pursuing the Ph.D. degree in electronic engineering at VNU, where his dissertation is focused on microwave circuit designs for wireless power transmission and high power semiconductor amplifiers.



Assoc. Prof. Bach Gia Duong was born in Ha Dong Dist, Ha Noi, Viet Nam, in 1950. He received the B.S degree in radio physics in 1972 and the Ph.D. degree in wireless physics from University of Science, in 1988. Since 2006 He is a Lecturer and Head of Electronics and Telecommunication Center, University of Engineering and Technology, Vietnam National University. He is the author of three books and more than 80 articles. His research focuses on RF Analog Signal Processing, RF chip design, Radar Engineering and Technology, Automatic Control.