

# *Analysis Of Cold Expanded Fastener Holes- FEM Approach*

Sriranjini.K.S<sup>a</sup>, Paurav Sardeshmukh<sup>b</sup>, Maanasa Bhat<sup>c</sup>, Dr. Shanmukha Nagaraj<sup>d</sup>

<sup>b,c</sup>Student, Department of Mechanical Engineering, <sup>a</sup>Department of Computer Science Engineering, R.V College of Engineering, Mysore Road, Bangalore-560059, India  
<sup>d</sup>Professor, Department of Mechanical Engineering, R.V College of Engineering, Mysore Road, Bangalore-560059, India

**Abstract-** Pre Stressing is a process of introducing residual compressive stresses zone around fastener holes which minimizes adverse effects of cyclic tensile stresses and retards the growth of fatigue cracks originating from the material flaws or surface imperfections. The present investigation is aimed at optimizing the inter hole distance between two adjacent cold expanded holes on a plate, limiting deformation of the material between holes to the elastic range by applying stress below the compressive yield strength of the material. It is found that ratio of central distance between holes to diameter of the holes ( $C/D$ ) has a significant effect on the stress contours induced for a given percentage of expansion. The plate is modelled as a thick cylinder and equations are derived for radial stress. Graphs for these equations are plotted in MATLAB. ANSYS is used to conduct finite element analysis (FEA) of the cold expanded Mild Steel plate with two holes. To find the optimum centre distance between the two holes, the distance between the two holes was varied from  $2D$  to  $3.6D$  in steps of  $0.2D$  and its effects, studied. The stress patterns in the vicinity of the holes from the analytical and Finite Element Methods were found to be comparable, proving the correctness of the approach. The relationship between  $C/D$  and percentage of expansion is analyzed, thus, optimizing the percentage of expansion required for a given  $C/D$ .

## 1. Introduction

### 1.1 Pre-Stressing of Holes:

Pre stressing is the process of introducing residual compressive stress zone around a hole in order to move the material around the hole in radial direction beyond the limits of elastic deformation. This zone minimizes the adverse effects of cyclic tensile stresses and retards the growth of fatigue cracks originating from the material flow or surface imperfection. The process inhibits the growth of small fatigue crack in older structures, and is a highly effective hole rework technique. Since the process is carried out at room temperature it is also popularly known as the cold hole expansion process. The process is quick, easy and cost effective without causing changes in metallurgy, amount of

material and complexities in manufacturing and maintenance. In aerospace and automobile industries, fastener holes are considered as potential crack initiation sites in components subjected to cyclic loading. The cold expansion process introduces a compressive residual stress field in the material surrounding these holes, thus, enhancing the service life of these critical components.

### 1.2 Split Sleeve Process:

The primary method that we have employed is the Split Sleeve Process. In this technique a split sleeve is slipped over a steel mandrel attached to a hydraulic puller. The assembly is then inserted into an accurately sized hole and the mandrel is drawn through the sleeve. The sleeve ensures that shear of the material surrounding the hole is minimized and the expansion process is essentially radial. Plastic deformation of the material occurs as the mandrel moves through the sleeve; then as the mandrel is withdrawn some elastic recovery takes place, leaving a permanent enlargement of the hole and the desired compressive residual stress.

Although cold working can enhance the fatigue life of aerospace components with fastener holes, calculations of crack propagation do not usually include the beneficial effect produced by cold working. A major obstacle preventing the inclusion of the benefit of cold working in a fatigue life calculation has been an uncertainty in the precise level of compressive residual stress obtained.

Experimental measurements of residual stress are difficult to make in the small volumes of material around the fastener holes; validated by comparison with experimental results where measurements are possible. It has been found that predicted residual stresses are sensitive to the details of the process, particularly the material characteristics.

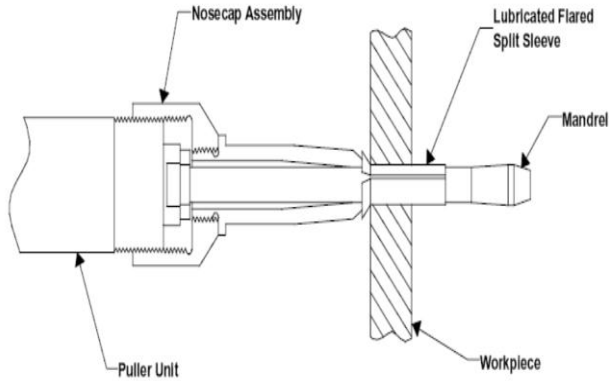

Figure 1. Split Sleeve -Cold Hole Expansion Process (FTI, 2002)

## 2. Scope of the Paper:

The present work is aimed at optimizing the inter hole distance between two holes limiting the deformation of the material at the centre of the plate to the elastic range. The trials are done for mild steel plate with a Young's modulus of 200GPa. The diameter of the chosen hole is 10mm and the thickness of the plate is 10mm.

The plate is modeled as a thick cylinder and equations are derived for radial stress. Graphs for these equations are plotted in MATLAB. ANSYS is used to conduct Finite Element Analysis (FEA) of the cold expanded Mild Steel plate with two holes. The trials are carried out for simultaneous cold expansion process. To find the optimum center distance between the two holes, the distance between the two holes was varied from 2D to 3.6D in steps of 0.2D and its effects, studied.

## 3. Mathematical Formulation

### 3.1 Equations for Radial Stress and Hoop Stress

Analysis is carried out by assuming the plate to be a thick cylinder. The basic concepts of the Strength of Materials are made use of for the mathematical formulation of the model. The Euler's equations are being made use of to mathematically calculate the C/D ratio. Several assumptions are made for the mathematical formulation.

The assumptions made for the mathematical formulation are:

- The material is isotropic and homogeneous.
- The effect of the plate edges is neglected.

- The plate assumed to be large enough for the model of thick cylinders to be valid
- The stress pattern for a single isolated hole is assumed to be uniformly distributed in radial direction along the circumference of the hole.
- It is assumed that only radial internal pressure is applied on the hole and the stresses in the other directions are neglected.

Nomenclature :

$\sigma_t$  = Hoop Stress (MPa)

$\sigma_r$  = Radial Stress (MPa)

$\epsilon_r$  = Radial Strain

$\epsilon_t$  = Circumferential Strain

$u$  = Radial Displacement (mm)

$r$  = Radial Distance (mm)

$\phi$  = Angle (in Radians)

$E$  = Young's Modulus (MPa)

$\mu$  = Poisson's Ratio

$P_i$  = Internal Pressure (MPa)

$P_o$  = External Pressure (MPa)

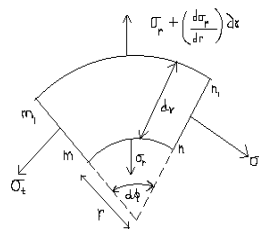

Figure 2.1a

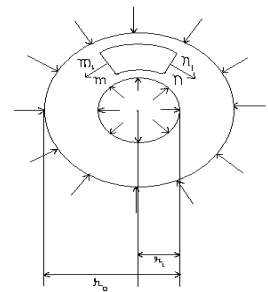

Figure 2.1b.

Consider an element in the cylinder as shown in the figure 2.1(a&b). The pressure acts only in the radial direction. Let the thickness of the cylinder considered be unity.

Equating the forces in the radial directions,

$$\left[ \sigma_r \cdot r \cdot d\phi \right] + \left[ \sigma_t \cdot dr \cdot d\phi \right] - \left[ \sigma_r + \left( \frac{d\sigma_r}{dr} \right) dr \right] \cdot (r + dr) \cdot d\phi = 0 \quad (1)$$

$$\sigma_t - \sigma_r - r \left( \frac{d\sigma_r}{dr} \right) = 0 \quad (2)$$

If  $u$  radial displacement at  $r$ , then  $u + \left( \frac{du}{dr} \right) \delta r$  is radial

displacement at  $r + \delta r$

$$\epsilon_r = \frac{du}{dr} \quad (3)$$

$$\varepsilon_r = \frac{u}{r} \quad C_1 = u/r \quad (4)$$

Expressing stresses in terms of Young's Modulus & Poisson's ratio,

$$\sigma_r = \left[ \frac{E}{(1-\mu^2)} \right] \left( \frac{du}{dr} + \frac{\mu u}{r} \right) \quad (5)$$

$$\sigma_t = \left[ \frac{E}{(1-\mu^2)} \right] \left( \mu \frac{du}{dr} + \frac{u}{r} \right) \quad (6)$$

Substituting for  $\sigma_r$  &  $\sigma_t$  in Eq.2

$$\left[ \frac{E}{(1-\mu^2)} \right] * \left[ \mu \frac{du}{dr} + \frac{u}{r} \right] - \left[ \frac{E r}{(1-\mu^2)} \right] * \left[ \frac{d}{dr} \left( \frac{du}{dr} + \mu \frac{u}{r} \right) \right] = 0 \quad (7)$$

$$\left[ \frac{E}{(1-\mu^2)} \right] * \left[ \frac{u}{r} (1-\mu) - \frac{du}{dr} (1-\mu) \right] - \left[ \frac{E r}{(1-\mu^2)} \right] * \left[ \frac{d^2 u}{dr^2} + \frac{\mu}{r^2} \left( r \frac{du}{dr} - \mu \right) \right] = 0 \quad (8)$$

$$\frac{d^2 u}{dr^2} + \frac{1}{r} \left( \frac{du}{dr} \right) - \frac{u}{r^2} = 0 \quad (9)$$

The general solution of this equation is:

$$u = (C_1 * r) + \left( \frac{C_2}{r} \right) \quad (10)$$

$C_1$  &  $C_2$  depends on the conditions at the inner and the outer surfaces of the cylinder.

Substituting from the Equation 10 in Equation 5 & 6,

$$\frac{du}{dr} = C_1 - \frac{C_2}{r^2}$$

$$\frac{u}{r} = C_1 + \frac{C_2}{r^2}$$

Therefore,

$$\sigma_r = \left[ \frac{E}{(1-\mu^2)} \right] * \left[ C_1 (1+\mu) - \frac{C_2 (1-\mu)}{r^2} \right] \quad (11)$$

$$\sigma_t = \left[ \frac{E}{(1-\mu^2)} \right] * \left[ C_1 (1+\mu) + \frac{C_2 (1-\mu)}{r^2} \right] \quad (12)$$

Applying Boundary Conditions, at

$$r = r_i, \quad \sigma_r = -P_i, \quad r = r_o, \quad \sigma_r = -P_o$$

Eliminating  $C_1$  &  $C_2$  from (11) & (12),

$$C_1 = \left[ \frac{(1-\mu)}{E} \right] * \left[ \frac{(r_i^2 * P_i) - (r_o^2 * P_o)}{(r_o^2 - r_i^2)} \right] \quad (13)$$

$$C_2 = \left[ \frac{(1+\mu)}{E} \right] * \left[ \frac{(r_i^2 * r_o^2) * (P_i - P_o)}{(r_o^2 - r_i^2)} \right] \quad (14)$$

Substituting in the equations of circumferential stress & radial stress

$$\sigma_r = \left[ \frac{(r_i^2 * P_i) - (r_o^2 * P_o)}{(r_o^2 - r_i^2)} \right] - \left[ \frac{(r_i^2 * r_o^2) * (P_i - P_o)}{r^2 (r_o^2 - r_i^2)} \right] \quad (15)$$

$$\sigma_t = \left[ \frac{(r_i^2 * P_i) - (r_o^2 * P_o)}{(r_o^2 - r_i^2)} \right] + \left[ \frac{(r_i^2 * r_o^2) * (P_i - P_o)}{r^2 (r_o^2 - r_i^2)} \right] \quad (16)$$

To optimize the distance between two cold expanded holes, the effect of stresses of one hole must be zero on the adjacent hole, Hence

$$\sigma_r = \left[ \frac{(r_i^2 * P_i)}{(r_o^2 - r_i^2)} \right] * \left[ 1 - \left( \frac{r_o}{r} \right)^2 \right] \quad (17)$$

$$\sigma_t = \left[ \frac{(r_i^2 * P_i)}{(r_o^2 - r_i^2)} \right] * \left[ 1 + \left( \frac{r_o}{r} \right)^2 \right] \quad (18)$$

Equations (17) and (18) give the values of radial and hoop stresses.

## 4. Finite Element Analysis

### 4.1 Methodology

Initially the system is modelled as a plate with two holes and the radial pressure is applied. The problem is solved by varying C/D ratio from 2 to 3.6 in steps of 0.2. The results and graphs are obtained for each case. The trials are repeated for 2%, 4% and 6% expansions. Limiting the stress in the centre of the plate to 1.5GPa, which is yield limit for mild steel in compression, the values of C/D are decided for each percentage of expansion. This prevents the plastic deformation of the material at the centre of the plate. The element type chosen is solid 185. 1, 2, 3,4,5,6 and I, J, K, L, M, N, O, and P in the Figure 4 represent the faces and nodes of the element respectively. The element type chosen is a 3D element with 3 degrees of freedom at each node. The features of this element

type are that it can be used for large deflections, large strain, stress stiffening, plasticity problem, creep and swelling. The elements must be refined around the holes

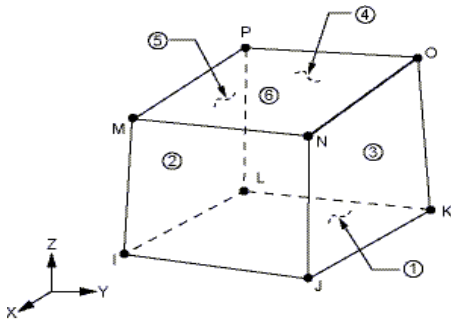

Figure 3. Schematic representation of SOLID 185 elements

To analyze small variations in the stress patterns. The Young's Modulus for the chosen material (mild steel) is 200GPa and the Poisons ratio is 0.3. The loads to be applied in each case are found out using trial and error method. Loads are changed for each trial until the displacement of a node at the edge of the hole corresponds to the desired percentage of expansion. The process consists of using a hardened, stainless-steel and internally lubricated split sleeve which is pulled over a tapered mandrel through the hole, causing very high radial pressures that expand the hole beyond the yield strength, resulting in a residual compressive stress after the mandrel removal. In the case of the 2D models the uniform hole expansion (radial interference) was defined as  $i = \left[ \left( \frac{D - d}{d} \right) * 100 \right]$  Where D is the diameter of the mandrel, d is the diameter of the hole and  $i = 2\%, 4\% \text{ and } 6\%$ .

## 4.2 2% EXPANSION

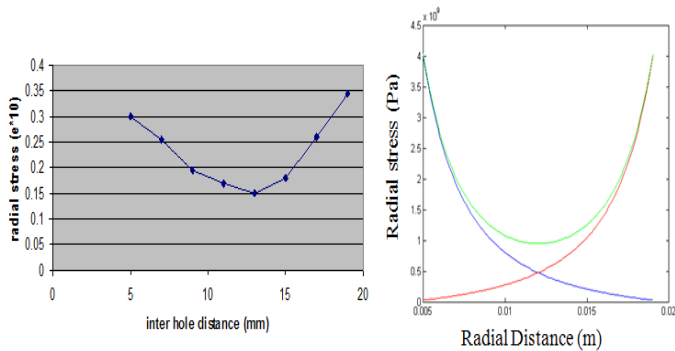

Figure 6 a. Variation of normal stress along the radial direction for C/D = 2.4 & 2% expansion

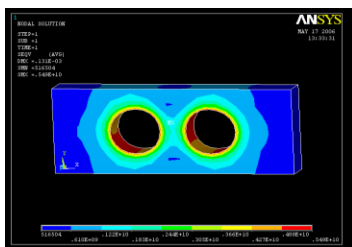

Figure 6 b. Von Mises Stress contour plot for C/D =2.4 (units in N/sq.m)

## 4.3 4% EXPANSION

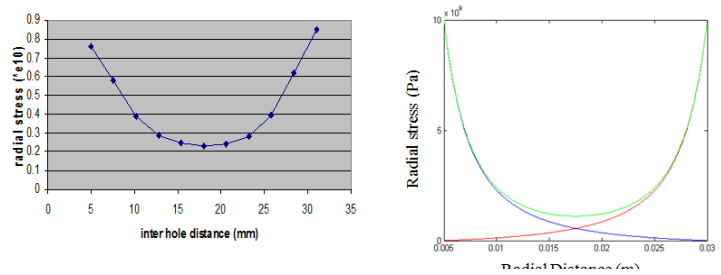

Figure 7 a. Variation of normal stress along the radial direction for C/D = 3.6 & 4% expansion

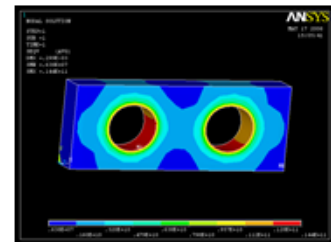

Figure 7 b. Von Mises Stress contour plot for C/D=3.6 (units in N/sq.m)

## 5. Conclusion

The designed model is found to be comparable with most of the common rivet holes application in automobile and

aircraft bodies, where the holes are along a straight line. We have studied the stress patterns in the vicinity of the holes and arrive at an approximate value of C/D. The stress patterns obtained from the analytical and Finite Element Methods were found to be in agreeable comparison which proves the correctness of the method followed.

The values of C/D ratios are noted for each percentage of expansion. A graph of limiting C/D v/s percentage of expansion is plotted. The graph is expected to follow an increasing trend. To obtain safe limits of percentages of expansion for a given C/D ratio, the values are either interpolated or extrapolated as required. The graph shown in Figure-8 represents the limiting values of percentages of expansion for mild steel plate with thickness of 10mm.

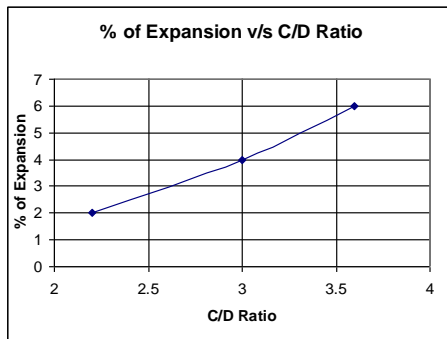

Figure 8. Percentage of expansion v/s C/D ratio

The stress patterns in the vicinity of the holes from the analytical and Finite Element Methods were found to be comparable, proving the correctness of the approach. The relationship between C/D and percentage of expansion is analyzed, thus, optimizing the percentage of expansion required for a given C/D.

The C/D ratio has a significant effect on the stress contours induced for a given value of percentage of expansion.

### Acknowledgement

We are thankful to the Hod and UG faculty of Department of Mechanical Engineering of R.V. College of Engineering for their support.

### References

- [1].J.T. Maximov, et al., A finite element simulation of the spherical Mandrelling process of holes with cracks (Technical University of Gabrovo, Bulgaria).
- [2].CheolKimet et al., Finite element analysis of the residual stress by cold expansion method under the influence of adjacent holes (Sung Kyun Kwan University, Suwon, South Korea).
- [3].de Matos et al., Residual stress effect on fatigue striation spacing in a cold-worked rivet hole

[4].P. Papanikos et al., Elasto-plastic Finite-element analysis of the cold expansion of adjacent fastener holes (University of Toronto, Canada)

[5].V.D. Lacarac et al., Prediction of the growth rate for fatigue cracks emanating from cold expanded holes, (University of Bristol, Bristol)

[6].Jordan T. Maximov, Finite element analysis of the spherical Mandrelling process of cylindrical holes (Technical University of Gabrovo, Bulgaria)

[7].P. Papanikos et al., Three dimensional finite element analysis of cold hole expansion of adjacent holes (University of Toronto, Canada)

[8].M.J. Pavier et al., A finite element simulation of the cold working process for fastener holes (Journal of Strain Analysis for Engineering Design)

[9].Poussard et al., Analytical and finite element predictions of residual stress in cold worked fastener holes (Journal of Strain Analysis).

[10].Guo W, Elastic-plastic analysis of a finite sheet with a cold worked hole, Eng Fracture Mechanics, 1993.

[11].S Timoshenko, Theory of Elasticity, McGraw Hill, 2004

[12].D V Hutton, Fundamentals of Finite Element Analysis, Mc Graw Hill, 2004

