

Versatile Applied For Agricultural Robot Vehicles

T.Balaji¹, R.Bhalamurugan¹, M.R. Stalin john², Dr.k.Velmurugan³
¹PG student, ²Assistant Professor, Professor³
Department of Mechanical Engineering, SRM University, Chennai, India.

Department of Mechanical Engineering, Sri Manakula vinayager Engineering College, India.

Abstract — This project is intended at creating a customized robotic vehicle or a platform, which can be useful for a multitude of applications. The proposed robotic vehicle fundamentally makes use of technologies like GPS and ZIGBEE/GSM, in addition to using an on board microcontroller and the drives and motors to race the vehicle. The vehicle can be adjure from a remote location, to certainly go from one point to another in terms of the GPS coordinates. So it is very important for us to advance the standard of our vitality in the future by using embedded system. This robotic vehicle once assemble can be useful for many assorted applications, like autonomous agricultural vehicles, video and audio surveillance, Motion detection in remote locations, for detection of hazardous conditions like nuclear radiations or poisonous gases in remote locations, communication jamming in remote locations etc. In this assignment an agricultural application like seeding or obstacle monitoring will be demonstrated using the robot. The robot can be used for automating various agricultural process and activities like seeding, harvesting, pest control etc.

Keywords— agricultural robot.

1. Introduction

Robots and robotic systems are increasingly being used in various industries today. Robotics has come a long way in the last 20 years, from its beginning in highly structured environments, where native intelligence on the part of the robot was not mandatory. Today, once prohibitive costs in developing on-board intelligence are plummeting, and robots are now gearing up to play a major role in less structured and more flexible manufacturing environments. In this assignment an agricultural application like seeding or obstacle detecting will be demonstrated using the robot.

An embedded system is a computer system contemplated for specific control function within a large system, often with real time computing constraints. It is embedded as part of a complete design often including hardware and mechanical parts. By contrast, a general purpose computer, such as a personal computer is designed to be flexible and to unite a wide range of end user needs embedded system controls many devices in common use today.

Embedded systems contain processing cores that are typically either microcontroller or digital signal processors. The key characteristic however is being dedicated to handled a particular task. Since the embedded system is dedicated to specific task, design engineers can optimize it to reduce the

size and coast of the product and increase the reliability and performance. Some embedded systems are mass product benefiting from economics of scale. Physically embedded systems range from portable devices such as digital watches and mp3 players, to large stationary installations like traffic lights, factory controllers, or the system controlling nuclear power plants.

The user interface to give the destination coordinates can be PC, on which the user can type in the destination location and then transmit it to the robotic vehicle using the ZIGBEE or GSM.

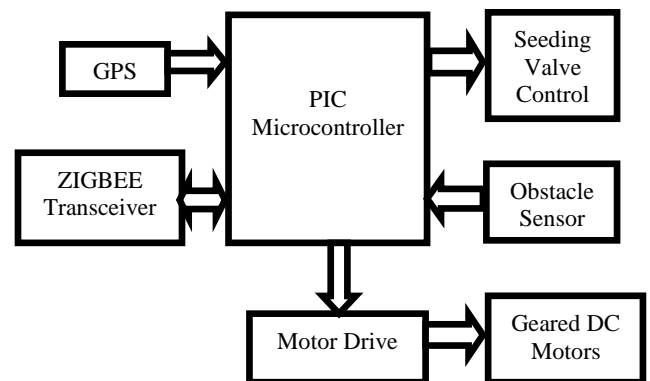

Fig 1. Robotic Vehicle Module

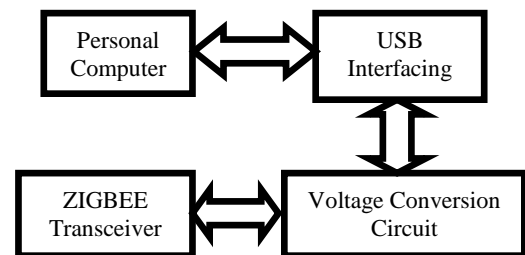

Fig 2. Monitoring System

2. Literature Review

Navigation in an unknown and unstructured outdoor environment is a fundamental and challenging problem for autonomous mobile robots. The navigation task requires identifying safe, traversable paths that allow the robot to progress toward a goal while avoiding obstacles. Standard approaches to complete the task use ranging sensors such as stereo vision or radar to recover the 3-D shape of the terrain. Various features of the terrain such as slopes or discontinuities are then analyzed to determine traversable regions. However, ranging sensors such as stereo visions only supply short-range perception and gives reliable obstacle detection to a range of approximately 5m. Navigating solely on short-range perception can lead to incorrect classification of safe and unsafe terrain in the far field, inefficient path following or even the failure of an experiment due to nearsightedness. To address nearsighted navigational errors, near-to far learning-based, long-range perception approaches are developed, which collect both appearances and stereo information from the near field as inputs for training appearance-based models and then applies these models in the far field in order to predict safe terrain and obstacles farther out from the robot where stereo readings are unavailable. We restrict our discussion to the online self-supervised learning since the diversity of the terrain and the lighting conditions of outdoor environments make it infeasible to employ a database of obstacle templates or features, or other forms of predefined description collections [1].

Eldercare is one of the most important healthcare concerns, particularly in countries such as Italy, Germany, and Sweden, and in the most rapidly aging nation of all, Japan. The number of Japanese who are 65 or older is already 29 million people, amounting to 23.1% of the population as of 2010. With the government's strategies to promote home-based elder-care and to reduce long-term hospital stays, home care services for elderly people are also growing. The number of home users has increased from 1.45 million people in 2001 to 2.41 million people in 2008. However, problems involving home care services are also increasing. There are fundamental problems with the variations in service quality of home care services. By their nature, home care services heavily depend upon a care-givers implicit knowledge about how to assist the elderly person in e.g. eating, rolling over in bed, and bathing. However, caregivers often have little time for study and training to master these practical skills. To address these problems, Yaguchi et al. proposed a care monitoring support system for home care services. Their system is designed to use the tacit knowledge shared among care-givers and supervisors in a more effective manner. We think that a Network Robot System will be a key technology for assisting elderly people, especially in home care services. The notion of the Network Robot System was defined by a European study group for the European Robotics Research Network, where robots communicate among themselves about the environment and people to fulfill their tasks. A network robot system consists not only of robots but also separately installed sensors and backend servers. Therefore, the robot need

not move around if the situation around people is monitored and intelligently processed in the backend server [2].

This paper details the design of a micro-controller based fuzzy logic controller for an agricultural Robot which can be used for ploughing, seeding and soil moisture sensing. The robots used in agriculture can reduce manpower and can be operated using remote controls from a distant place. In this work, an agricultural robot is designed with an internet based remote control using LAB VIEW and its position and speed control are discussed. Fuzzy logic controller is designed to change the steering angle and the speed of the robot according to the desired reference position. Differential drive is used to control the steering angle and the speed of the robot. The two DC motors are connected with the rear wheels of the robot. They are controlled by a fuzzy logic controller to offer accurate steering angle and the driving speed of the robot. The designed controller has two loops with an Outer Fuzzy Speed Control Loop and an Inner Current Control Loop. The control logic was implemented using 89C51 Microcontroller and the results are documented. The Robot control is implemented from a remote place using internet and web publishing tool in Lab VIEW. This Lab VIEW software enables complex and expensive equipment to be replaced by simpler and less expensive hardware. The agricultural Robot with the designed controller can be controlled from any distant computer. Thus this agricultural Robot control reduces the manpower and becomes advantageous and cost-effective. So many methods exist for ploughing the field. Earlier days we are using Cattle to plough the field, after that tractor is introduced for this application [3].

3. Embedded Systems

Embedded System is a composite of hardware and software used to achieve a single task. Embedded systems are computer systems that monitor, respond to, or control an external environment. Environment connected to systems through sensors, actuators and other I/O interfaces. Embedded system must unite timing & other constraints imposed on it by environment. An Embedded system is a component within some larger system. It is contrast with general-purpose computers. The software in the embedded system is termed firmware. An Embedded system is an intelligent firmware designed for a definite process to be achieved perfectly [4]. An Embedded system, in general, incorporates hardware, operating system, and peripheral devices and communication software to enable to accomplish the predefined functions [4].

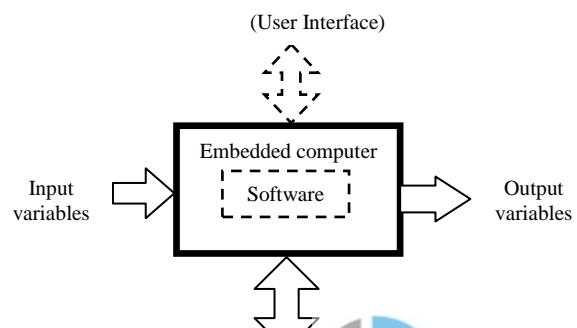

Fig 1. Embedded System [4]

In contrast to desktops that perform a variety of tasks, an embedded system achieves a single, well-defined task. The system has a processor, associated peripherals, and software for a specific purpose. For example, in a mobile phone the embedded processor need to process voice (to send and receive speech signals) as well as communication protocol [4]. Modern automobiles, industrial control systems, aircrafts, office automation products have a number of special purpose computer hardware and associated software embedded in them to accomplish specific functions [4].

4. Global Positioning System

The main section, we track the position of vehicle using a device called GPS. Basic information like Location, Time, and Speed can be determined by any GPS receiver. Additional features like maps and navigation are also available on many commercial GPS receivers. In the project GPS information is used to detect the present location and calculate the path to the desired location. The network of satellite that continuously transmits coded information, which makes possible to precisely identify locations on earth by measuring distance from satellites. The satellite transmits very low power radio signals allowing anyone with a GPS receiver to determine their location on earth. This remarkable system was not cheap to built, costing the US billions of dollars. Ongoing maintenance, including the launch of replacement satellites, adds to the cost of the system. Amazingly, GPS actually predates the introduction of the personal computer [5].

The below figure shows most commonly used GPS receiver. It is a low- power, ultra-high performance, easy to use GPS receiver based on SiRF's latest third generation single chip. The standard NMEA0183 outputs data using datum of WGS-84. Its low power consumption and high performance enables the adoption of AVL and other location based applications. It supports different electrical interfaces such as USB, RS232, TTL etc. Basic information like Location, Time, and Speed can be determined by any GPS receiver. Additional features like maps and navigation are also available on many commercial GPS receivers. The project uses a G mouse type GPS receiver that gives the location information as data. GPS information is used to detect the present location and calculate the path to the desired location [5].



Fig 2. GMOUSE-101

5. Visual Basic

Visual basic is a easy to use and program windows based software. VB can be applied to create easy to use and view front ends for any windows based applications. VB is used to enable a easy to used GUI (Graphical User Interface) for the user. Visual Basic uses graphical, forms – based approach to application and development. The typical way to write a program in Visual Basic is to create a form, drag and drop controls onto the form, set properties for the form and its controls, adds application – specific code to handle events. It sounds simple, but we can write very powerful applications in this manner [6].

5.1 Rapid Application Development (Rad) Tools:

Visual Basic is Microsoft's RAD tool for window programmers. Rapid Application Development tools abet as to create applications in a shorter time as compared to conventional languages and with limited errors. RAD tools help us to create a range of applications. These could range from a small utility for our workgroup or us to large enterprise- wide system, or even distributed applications spanning the globe via the Internet. In case of large applications, RAD tools enable the developers to create a prototype of the large application. Such a prototype enables a user to understand the "Look and Feel" of the application. In some cases RAD tools enable us to minimize and simplify code writing [6].

5.2 Visual Programming

Visual programming aligned at providing the user with an interface that is intuitive and easy to use. In developing such an interface, the programmer employs user-friendly features such as windows, menus, buttons, list boxes etc. A visual programming environment provides all features that are required to develop a graphical user interface as ready to use components. The programmer does not have to write code to create and display commonly required user-friendly features

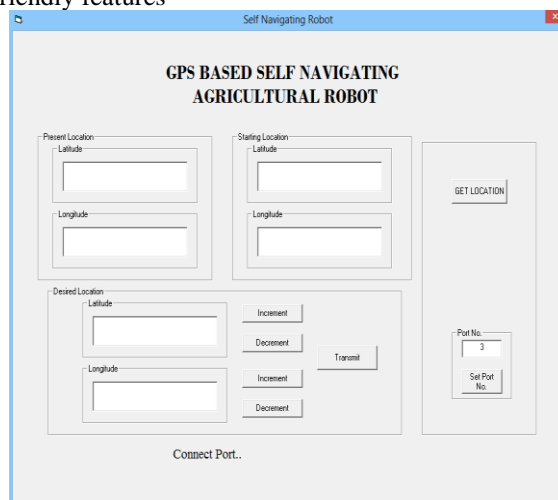

Fig 3. Output Window in Visual Programming

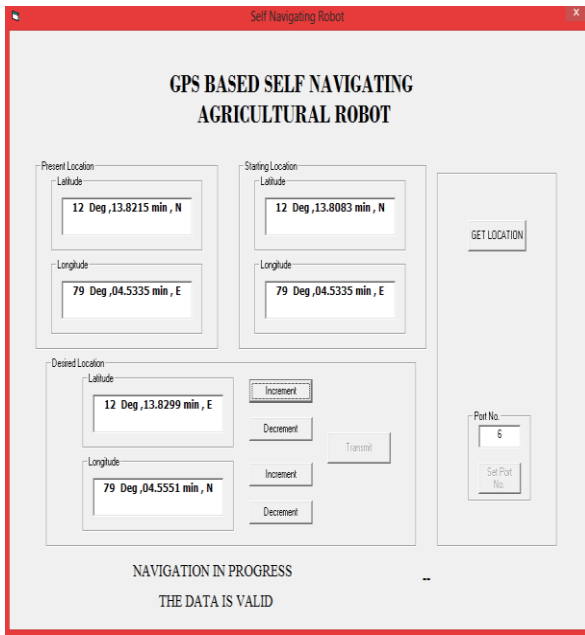

Fig 4. Navigation Progress

each time around. In Visual Basic, variables are temporarily store values during the execution of on application. Variable names in Visual Basic can be up to 255 characters long and provides the first characters is a letter followed by number of letters, numbers and underscores. The data type of variable determines how the values in a variable are stored in computers memory[6].The figure shows the output of the Visual Basic program. The self navigating robot window is opened when the port is connected as shown in the figure 3. The values are assigned and navigation takes place when the transmit button is Chosen. The figure 4 illustrates the navigation process takes place when the values are assigned.

5.3 Detecting The Obstacle

The robotic vehicle used here is given as in the following figure.

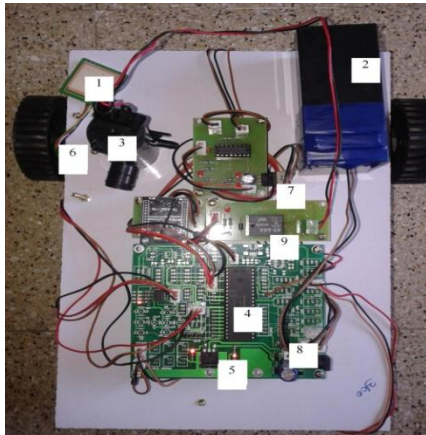

Fig 5. Robotic Vehicle Platform

- | | |
|-----------------|-----------------------|
| 1.GPS Receiver | 6.DC Motor |
| 2.Battery | 7.NPN Transistor |
| 3.Seeding Valve | 8.Master Clear Switch |
| 4.PIC | 9.Relay |
| 5.LED | |

GP2Y0A21YK0F Obstacle sensor is a distance measuring sensor unit, composed of an integrated combination of PSD (position sensitive detector) , IRED (infrared emitting diode) and signal processing circuit.The variety of the reflectivity of the object, the environmental temperature and the operating duration are not influenced easily to the distance detection because of adopting the triangulation method.This device outputs the voltage corresponding to the detection distance. So this sensor can also be used as a proximity sensor.



Fig 6. Obstacle Sensor

Obstacle sensor was fixed at the front side of the vehicle as shown in the figure 7. It detects the obstacle within the distance of 10 to 80cm.



Fig 7. Obstacle sensor fixed in the embedded vehicle
 1. Obstacle Sensor 2.Stepper Motor

The obstacle detector detects the output as it is fixed in the front side of the embedded vehicle. The vehicle stops automatically when it detects the output.



Fig 8. Detection of the Obstacle

Figure 8 shows the detection of the obstacle. It is indicated in the output window and when the obstacle was cleared, the vehicle moves on its own and reaches the destination. The obstacle detected is indicated as shown in figure 9.

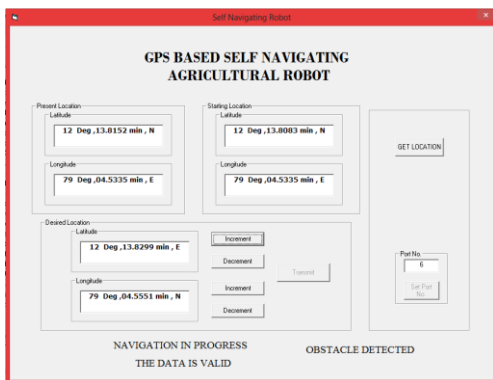

Fig 9. Indication of the output

6. CONCLUSION AND FUTURE PROSPECTS

Finally we conclude that our proposal used to humiliate the human effort in agriculture. In the existing system the robot is built for some specific application such as (a) Fruit Harvesting, (b) Transplant Handling, (c) Sheep Shearing, (d) Meat Cutting. It does not reach the destination on its own. In proposed system the single robot can be used for composite applications involving sensors and control software. The robotic vehicle can be directed from a remote location, to detect the obstacle and reach the destination on its own.

This assignment can be developed for various applications like Leaf Cutting and fruit picking. In future robotic vehicle preclude the obstacle on its own by taking new path to reach the destination. It can be worn for monitoring several ventures in agricultural applications such as soil condition monitoring, crop monitoring and Water Level Monitoring.

REFERENCE

- [1] Wang Mingjun, Wang Xuefeng, Yi Xinhua, Experimental study on long-range navigation behavior of agricultural robots ,2012 International Conference on Computing, Measurement, Control and Sensor Network.
- [2] Michiharu Kudo, Robot-Assisted Healthcare Support for an Aging Society, 2012 Service Research and Innovation Institute Global Conference.
- [3] K. Prema, N. Senthil Kumar, S.S. Dash, Sudhakar Chowdar, Online control of remote operated agricultural Robot using Fuzzy Controller and Virtual Instrumentation, IEEE-International Conference On Advances In Engineering, Science And Management (ICAESM -2012) March 30, 31, 2012.
- [4] www.embeddedsystem.com
- [5] www.garmin.com>Home>about GPS
- [6] www.vbtutor.net



Balaji Thirunavukkarasu, born in Tamil Nadu, India on 13th May 1989, obtained his B.E degree in Mechanical Engineering in 2011 from the Anna University, Chennai and he is currently pursuing his M.Tech in Robotics at SRM University, Chennai.

With his thirst for research in Robotics, he successfully completed a Government Project on Solar Aircraft of Unmanned Aerial Vehicle Design for the Tamilnadu State Council for Science and Technology, during 2011.

His project on Simple Aircraft Designing was identified as the best project in the Youth Science Festival organized at Kongu Engineering College, Erode, in 2010. He remarkably secured the second position in the Zonal Ground of the IURL-US ROBO League, held at Cauvery College of Engineering and Technology, Trichy, in 2012.

This budding researcher has also received Best Project Awards and the Young Scientist Award for his innovative projects on Robotics /Aircraft Design in various forums from different organizations. He has also published more than 12 papers in leading national and international conferences and reputed journals.