

A Novel Design of Lightweight Aluminum Tubular Crash-Box for Crashworthiness Application

Faris Tarlochan, S.V. Perumal, Khalifa Al-Khalifa, Abdel Magid Hamouda

Abstract— During a collision, the specific structures such as the frontal longitudinal and crash-box deforms plastically while absorbing substantial amount of kinetic energy. This energy absorbing characteristic has been designed in vehicles to reduce the severe injury of occupant. The design of such structures are very important because if these structures deform due to very high forces there is high risk to biomechanical damage of the vehicle occupants. Hence it is of utmost importance that the design of such structures maximizes the energy absorption while maintaining the peak force below an allowable threshold. The current work aims to design a new multi tube thin walled crash-box with these two crashworthiness performance measures being given much attention. The distance of the first plastic fold for the axial crushing was determined by simulation and this was used as a design input. This resulted in a near to ideal elastic-plastic behavior, increasing energy absorption and stable crushing compared to a single aluminium tube and steel equivalent.

Keywords— *Crashworthiness, Energy Absorption, Aluminum Tubes, Frontal Longitudinal*

I. INTRODUCTION

Car manufacturers of the current era are facing new challenges in bringing their products to the market. Several factors over the last three decades such as the environment, crude oil prices and efficiency are forcing radical change. A push for lighter vehicles paved the way for exploration on the usage of composite sandwich materials. Faris (et al. 2007), Faris and Ramesh (2012a, 2012b) have shown that indeed composite sandwich material have good energy absorption capability, better to that of the metal counterpart.

Assoc. Prof. Dr. Faris Tarlochan
College of Engineering / Qatar Road Safety Studies Center
Qatar University
Doha, Qatar

Surin Perumal
Kuala Lumpur, Malaysia

Asst. Prof. Dr. Khalifa Al- Khalifa
College of Engineering / Qatar Road Safety Studies Center
Qatar University
Doha, Qatar

Prof. Dr. A.M.S. Hamouda
College of Engineering / Qatar Road Safety Studies Center
Qatar University
Doha, Qatar

However, the issue of mass production has inhibited the usage of such material. Aluminium on the other hand is increasingly gaining ground as the choice material for vehicle body and chassis since it is light, easy to recycle and has better strength properties on a weight basis when compared to steel. One can surmise from published works that an aluminium space frame can reduce weight by 19 - 31% (Stodolsky et al., 1995; Langseth and Hopperstad, 1996). This benefits fuel consumption by about 12.5% to 20% and reduces emission of CO₂. The extra cost of aluminium part manufacture is recouped after second or third year of vehicle use depending on mileage. The energy absorber should meet its energy absorption requirement without its own weight being a penalty (Lu and Yu; 2003).

Langseth et. al. (1998) performed non-linear finite element simulations on square aluminium extrusions subject to axial loading to compare the reliability of predictions made theoretically. Che et. al. (2007) conducted research on crash behavior of a complicated cross-section with different thicknesses of aluminium extrusion under axial loading. The influence of extraction position on stress vs. strain curve and damage parameters were compensated for by specimen extraction from several locations on the main component. The Gurson damage model was used to simulate tensile and compressive loads. The validation was based on data from accompanying tensile and shear experiments. Kim (2002) in numerical work on new multi-cell aluminium extrusion reports that strain rate effects can be ignored since aluminium is strain rate insensitive. 4-node Belytschko-Tsay shell element was used for modeling the whole structure while elastic-plastic isotropic thin shell was specified for the shell element. The multi-cell approach is based on works by Lee and Wierzbicki (2001) whose observations bring to light the effect of increasing material in the corner section of square extruded columns to maximize crash energy absorption. Jensen et. al (2004) performed static and dynamic experiments on tubes of varying geometry to study the correlation between deformation behaviour and impact velocity.

Looking at the literature, there is still a major uphill task to seek for an ideal sectional configuration for the energy absorbing structure that has good crashworthiness parameters. Hence, the objective of the current study is to design a novel energy absorber crash-box to lower impact peak loads while deforming in a controlled manner with high energy absorbing capabilities. The impact velocity was set at 18 m/s which is the



current Euro NCAP test value. This study is achieved via a robust finite element (FE) model which was verified using published works and mesh sensitivity analysis.

FINITE ELEMENT MODEL

This section presents the finite element (FE) model used for aluminium tubes under crash loads. The numerical tube model was based on the experimental work of Jensen et. al (2004). This body of work is relevant to this study as the loading condition closely matches the Euro NCAP impact velocity requirements. Table 1 shows the specimen properties and loading conditions for the chosen impact tests as used by Jensen et. al. (2004).

Table 1: Material, Geometry and Loading Conditions for experimental work of Jensen et. al 200

Material Type		Aluminum AA 6060 T6
Thickness (mm)		2.0, 2.5, 3.5, 4.5
Length (mm)		1920
Cross section (mm ²)		80 X 80 (constant)
Impactor	Mass (kg)	600
	Velocity (ms ⁻¹)	20
	Energy (kJ)	120

FE Model description

The tube was modeled using the stress-strain data of AA 6060 T6 extrusion approximated from the work of Jensen et. al (2004). This material has the following mechanical properties: Young's Modulus, $E = 68.3$ GPa, Poisson's ratio, $\nu = 0.3$ density, $\rho = 2700$ kg/m³ and yield strength = 250 MPa. The material's deformation behaviour is governed by two distinctive regions; the first part of the stress-strain curve exhibits elastic behaviour, while the second part deforms plastically. In the simulation, these regions are modeled as elastic and power hardening plasticity respectively. The plastic response specifically is modeled as isotropic plasticity. Hooputra et. al (2004) state that plastic orthotropic behaviour is prevalent when aluminium extrusion undergo dynamic loading. However, this behaviour is dependent on the loading i.e., strain rate the material is subjected to. According to Langseth et. al (1998), Hanssen et. al (2000), Zhang et. al (2009), Deb et. al. (2010), Al Galib et. al. (2004) for strain rates in the region of 100 s⁻¹ aluminium extrusion of the chosen variety is strain rate insensitive. The test velocity used here falls in this range. Besides this as reported by Jensen et. al (2004), aluminium AA6060-T6 experiences insignificant anisotropy in strength. Hence the assumption of isotropic plasticity usage as the material model is justified.

The model's size and dimensions are exactly as tested as given in Table 1. The length of 960 mm which is longer than most crush box members was intentionally chosen to test the capability of the FE software to accurately replicate the fold pattern as published in the work of Jensen et. al (2004). To

replicate the experimental work, the tube to be crushed was mounted on a rigid steel base. The impactor was also modeled as a rigid body with specified mass of 600kg as per the experiments (Jensen et. al 2004) with an impact velocity of 20 m/s. The boundary conditions were used to fix the rotation and displacement at the base.

The mesh size can influence the numerical results to a great extent. The element chosen for the model was a 4-node doubly curved shell. Further enhancement is achieved by applying reduced integration, hourglass control and maximum degradation control. Mesh sensitivity analysis was performed to determine the ideal mesh size. The goal here was to obtain accurate results while economizing time and computing power. The ideal element size for the present work was determined to be 5 mm after intensive mesh sensitivity analysis. The finding is similar to that reported by Hooputra et. al (2004).

DESIGN METHODOLOGY

A typical force-displacement response is shown in Figure 1a. The peak load is typically much higher than calculated mean load and is undesirable in a crash situation. Ideally the load must rise to a force value (threshold) that will cause no harm to passengers and remain at that value for the subsequent deformation (Figure 1b). The initial high peak load is caused by the formation of the first plastic fold. Depending on the specimen or component geometry, subsequent folds begin to form after or during the formation of the first fold. The reaction force value oscillates around the lower mean force value since the components ability to withstand the force has been compromised. Each subsequent smaller peak represents one fold. Most published research work focus on lowering the peak force and increasing energy absorption.

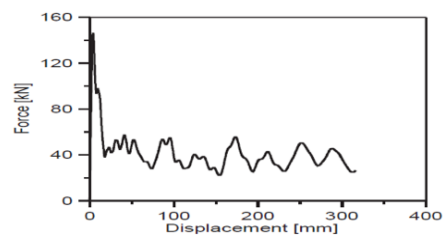

Figure 1a: A typical force-displacement plot

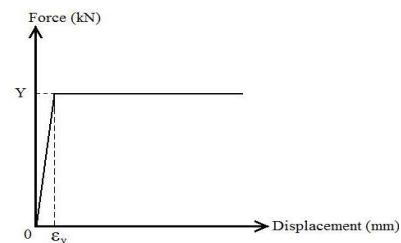
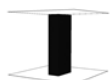
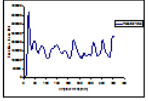
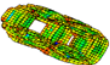

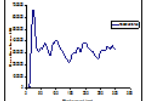
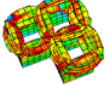
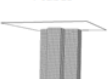
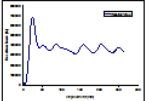
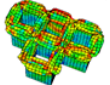

Figure 1b: An ideal force-displacement

An ideal force-displacement response would be similar to that shown in Figure 1b. A comparison of Figures 1a and 1b shows that the peak loads value can reach values that are much higher than the mean load. Also, the load bearing capacity of a tube after the initial fold formation is severely penalized since subsequent folds operate at a lower reaction force value. Additionally a qualitative analysis of several published works show that the crush behavior of the tube also varies with geometry and loading. This means the specimens could deform in a non-progressive mode or even fail under cracking. While filling a tube with foam can improve energy absorption, the peak force still significantly overshoots the subsequent forces. Thus the hypothesis is to smoothen out the oscillations and reduce the peak force to mimic the ideal force-displacement behavior as depicted in Figure 3b. To investigate this hypothesis; a set of preliminary numerical simulations was set up to study the effect of adding tubes around a main central tube. Table 1 shows the progression of the energy absorber design from single to four tubes of similar length.

Table 1: Effect of tubes around a main central tube

Specimen Type			Simulation Result			
Length	Width	Energy absorber before loading	Peak force	CFE	Load displacement plot	Energy absorber after crushing
400	80	2 tubes 	370 kN	0.41		
400	80	3 tubes 	660 kN	0.49		
400	80	4 tubes 	686 kN	0.53		

From Table 1 it is clear that the addition of tubes around the periphery of the central main tube improves the crush force efficiency and stabilizes the force oscillations after the peak force. Crush force efficiency (CFE) is defined as the ratio of the mean force to the initial peak force. Nonetheless, the peak force rises as the numbers of tubes were increased.

Based on the preliminary study, tubes around the periphery of the central main tube will be used as the basis of the conceptual designs. Here, the conceptual designs are to improve the energy absorbed and maintain a constant peak load that will not endanger the occupants. The conceptual designs are meant to substitute the crash box component of vehicle front ends (Figure 2). The crash box typically sits in between the S-frame and front cross member.

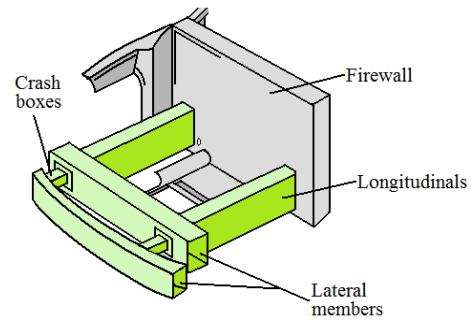

Figure 2: Crash box location in frontal longitudinal

The conceptual design framework developed is represented in Figure 3. The concept was developed by placing additional tubes which will be referred to as component tubes around the perimeter of the main central tube. The height of these surrounding component tubes however was varied according to the occurrence of plastic fold in the main tube. Therefore, if the first fold occurs at approximately 15 mm below the load plate, the next tube was 15 mm shorter. Additional tubes around the periphery provide added wall strength to the tubes. The height is strategically reduced to prevent the tubes from becoming over stiff since this can lead to undesirable peak loads. Table 2 shows the various possibilities of the proposed concept.

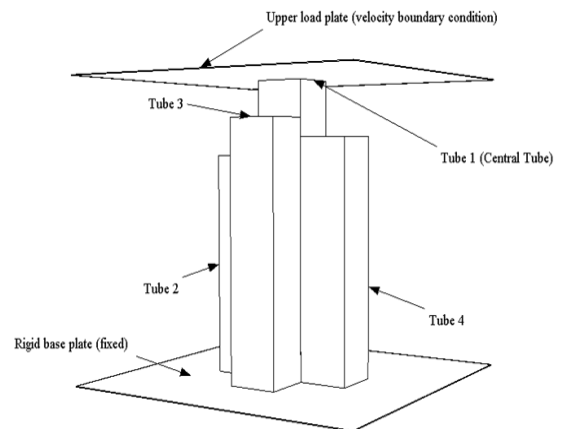

Figure 3: Design concept of aluminum tubes

The finite element model of the concepts has two rigid parts as shown in Figure 3. The upper rigid part or load plate is specified with a displacement boundary condition in the negative z-direction. The lower rigid part or base plate is specified with fixed rotation and fixed displacement boundary conditions. The direction here is based on Cartesian coordinate system. The load plate was also given a predefined velocity of magnitude 18 m/s. The velocity is as used by the current Euro NCAP test values (18 m/s) to replicate a working load (European New Car Assessment Programme 2009). The impact mass of 600 kg per energy absorber was selected to reflect collision in the normal direction (head-on) with a vehicle of mass 1200 kg at 18 m/s.

Table 2: Various design concept of aluminum tubes with respect to Figure 3

Concepts	Central Tube 1, L1 (mm)	Length difference L ₁ L ₂ , (mm)	Length difference L ₁ L ₃ , (mm)	Length difference L ₁ L ₄ , (mm)	Thickness (mm)	Width (mm)
1	400	100	200	75	1	80
2	400	100	200	300	1	50
3	400	100	200	300	3	50
4	400	25	200	75	3	80
5	400	100	50	75	3	80
6	400	100	50	300	3	80
7	300	100	50	300	1	80
8	400	25	200	75	3	50
9	300	25	200	75	1	80
10	300	25	50	300	1	50
11	300	25	50	75	3	50
12	300	25	50	75	1	50

This equates to 97.2 kJ of energy that must be absorbed per energy absorber. Typically the energy absorber which is used in the crush box space has to absorb around 10% of this energy (Witteman, Willibrordus J 1999). However, in this work the energy absorber is intentionally designed to absorb all of this energy for normal impact load since it is intended to perform well even under oblique loading. Oblique loading always sees the crush force efficiency of an energy absorber diminished because it involves a combination of global bending and plastic buckling.

RESULTS AND DISCUSSION

ENERGY ABSORPTION CHARACTERISTICS AND CRUSHING BEHAVIOUR UNDER NORMAL LOADING

The numerical simulation obtained as mentioned in the previous section involved several combinations of length and thickness. The run which produced the best results in terms of plastic fold formation, peak load and energy absorption for normal loading along the tube longitudinal axis had a width/thickness (b/h) ratio of 26.67 for all constituent tubes. This design deformed in a global symmetric collapse mode which was progressive. Buckling is initiated at the impacted end followed by the formation of two similar lobes on opposing faces. Figure 4 shows the original and crushed tubes.

The simulation also shows that all the kinetic energy from the impact is converted into internal energy of the energy absorber. The internal energy increases up to 96.8 kJ which is very close to the total impact energy. The internal, kinetic, and artificial strain energy plots are shown in Figure 5. The energy absorber also shows good crushing behavior as it is able to maintain a steady value of reaction force after the initial elastic phase. The peak load is 356 kN and mean load by averaging the instantaneous forces is 279 kN. Figure 6 shows the reaction force-displacement plot with mean load for the energy absorber. The impact energy is 97.1 kJ as obtained from the simulation. This is very close to the system energy by calculation which is 97.2 kJ. The energy absorber absorbs close to 100% of this system energy. Crush force efficiency is a criterion used in the current work to evaluate the performance of the energy absorber. Crush force efficiency is

defined as the ratio of the mean load to the initial peak load. The crush force efficiency is currently 78%.

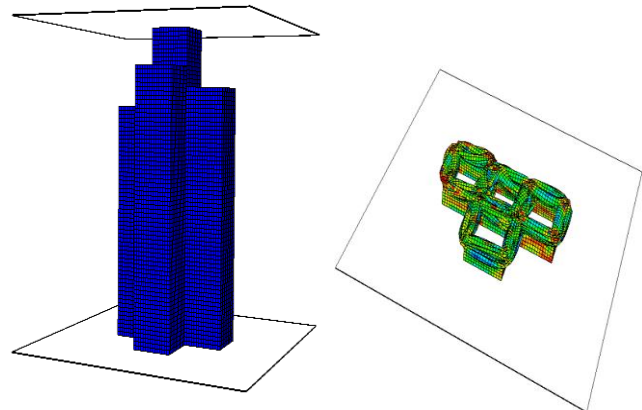

Figure 4: Before and after the crushing

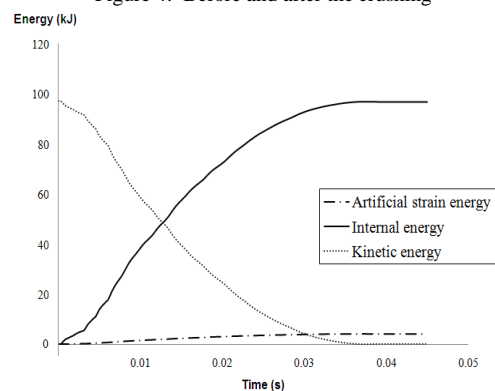

Figure 5: Various energies in the system

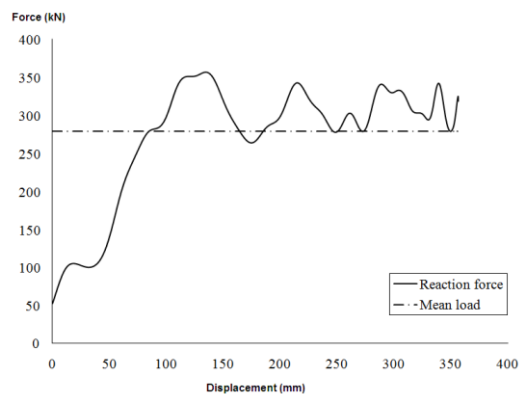

Figure 6: Force displacement diagram of the selected concept

Table 3 features the comparison with a simple single square aluminium tube subjected to the same load. This serves to highlight the benefits offered when a multi tube absorber in the configuration and dimensions proposed here is used instead of a single tube. It is also important to note that a single steel tube (high strength low alloy type) having a square cross section and dimensions similar to the single aluminium tube has mass of 2.90 kg. This is 19% lighter than the new type of energy absorber proposed but has significantly higher peak force under a similar load due to steel's inherent stiffness.

Table 3: Comparison with a simple single square aluminum

Tube type		Multi-tube energy absorber	Single Aluminum Tube
Physical dimensions	Width (mm)	80	80
	Thickness (mm)	3.0	3.0
	Mass (kg)	3.43	1.0
System energy (kJ)		97.2	
Peak load (kN)		356.48	217.88
Mean load (kN)		279.09	79.79
Absorbed energy (kJ)		97.10	46.37
Critical fracture energy (kJ/m)		275.95	24.30
Crush force efficiency		0.78	0.36
% energy absorbed		99.90	47.70

References

ENERGY ABSORPTION CHARACTERISTICS AND CRUSHING BEHAVIOUR UNDER OBLIQUE LOADING

Since vehicles may also encounter collision at an oblique angle, the performance of the energy absorber under oblique loading was also investigated. The oblique loading angle was 300 from the tube's longitudinal. The oblique velocity used was still 18 m/s. Here the peak load and mean load is 231.66 kN and 147.39 kN respectively. The energy absorbed is 48.21 kJ. For the case of oblique loading the crush force efficiency is 63.6% which is less than the crush force efficiency for normal loading but still more than 50% efficient. It is also important to consider the impact of increased weight due to the multi-tube energy absorber. Using the test parameters from the simulations, the energy required moving a stationary vehicle of mass 1200 kg up to a speed of 18 m/s is 194.4 kJ. When the aluminium multi-tube energy absorbers are added, the mass increase is 1.06 kg compared to steel components which are each 2.90 kg. Now the energy required is 194.6 kJ. This is an increase of 0.09% which has a negligible impact on fuel economy.

V. CONCLUSION

The current work has successfully simulated the crushing behavior of an aluminium tube under dynamic load. The numerical model is influenced by mesh element size, element type and boundary conditions. The working model was then used to perform a set of experiments on a new crash energy absorber concept. The proposed design has a crush force efficiency of 78% for normal loading and 63.6% for oblique loading at 300. Additionally, the tubes deform in a stable progressive mode. The energy absorber design proposed here is preliminary. It can be further improved by adjusting the thicknesses of the tubes adjacent to the central tube and adding foam to improve energy absorption. This is the subject of further research to this existing study.

- [1] F. Tarlochan, A.M.S Hamouda, B.B. Sahari, E. Mahdi., 2007. Composite sandwich structures for crashworthiness applications, Proceedings Of The Institution Of Mechanical Engineers, Part L : Journal Of Material: Design And Application, 221 (2): pp. 121 – 130
- [2] F. Tarlochan, S. Ramesh, 2012a. Advanced Composite Sandwich Structure Design for Energy Absorption Applications: Blast Protection and Crashworthiness. Composites Part B: Engineering 43 (5): pp 2198-2208
- [3] F. Tarlochan, S. Ramesh., 2012b. Composites Sandwich Structures with Nested Inserts for Energy Absorption Applications. Composite Structures 94, (3): pp 904-916
- [4] F. Stodolsky, A. Vyas, R. Cuenca, L. Gaines., 1995. Life- cycle energy savings potential from aluminium-intensive vehicles. Total life cycle conference & exposition. Vienna, Austria.
- [5] M. Langseth, O. S. Hopperstad, 1996. Static and dynamic axial crushing of square thin-walled aluminium extrusions, Int J Impact Eng, 18: pp 949-968.
- [6] G. Lu, T. Yu, 2003. Energy absorption of structures and materials. Cambridge, Woodhead Publishing Limited: pp 20-24.
- [7] M. Langseth, O. S. Hopperstad, A. G. Hanssen, 1998. Crash behaviour of thin-walled aluminium members, Thin-Walled Struct, 32: pp 127-150.
- [8] H. Y. Che, L. Zhu, D. Z. Sun, J. H. Chen, H. Zhu, 2007. Characterization and modeling of aluminium extrusion damage under crash loading, Thin-Walled Struct. 45: pp 383-392.
- [9] H. S. Kim, 2002. New extruded multi-cell aluminium profile for maximum crash energy absorption and weight efficiency, Thin-Walled Structures, 40: pp 311-327.
- [10] Y.W. Lee, T. Wierzbicki, 2001. Effect of material distribution on axial and bending response of extruded aluminum profiles. Impact and crashworthiness laboratory report 56, Massachusetts Institute of Technology.
- [11] O. Jensen, M. Langseth, O. S. Hopperstad, 2004. Experimental investigations on the behaviour of short to long square aluminium tubes subjected to axial loading, International Journal of Impact Engineering, 30: pp 973-1003.
- [12] H. Hooputra, H. Gese, H. Dell, H. Werner, 2004. A comprehensive failure model for crashworthiness simulation of aluminium extrusions, International Journal of Crashworthiness, 9(5): pp 449-464.
- [13] A. G. Hanssen, M. Langseth, O.S. Hopperstad, 2000. Static and dynamic crushing of square aluminium extrusions with aluminium foam filler, International Journal of Impact Engineering, 24: pp 347-383.
- [14] X. W. Zhang, H. Su, T. X. Yu, 2009. Energy absorption of an axially crushed square tube with a buckling initiator, International Journal of Impact Engineering, 36: pp 402-417.
- [15] A. Deb, M. S. Mahendrakumar, C. Chavan, J. Karve, D. Blankenburg, S. Storen, 2010. Design of an aluminium-based vehicle platform for front impact safety, International Journal of Impact Engineering, 30: pp 1055-1079.
- [16] D. A. Galib, A. Limam, 2004. Experimental and numerical investigation of static and dynamic axial crushing of circular aluminium tubes, Thin-Walled Structures, 42: pp 1103-1137.
- [17] Wierzbicki T., Abramowicz W., 1983. On the crushing mechanics of thin-walled structures, Journal of Applied Mechanics, 50: pp 727-739.
- [18] European New Car Assessment Programme, Frontal Impact Testing Protocol, 2009
- [19] Witteman, Willibrordus J 1999. Improved Vehicle Crashworthiness Design by Control of the Energy Absorption for Different Collision Situations. Universiteitsdrukkerij TU Eindhoven, Dissertation.
- [20] L. Mirfenderski, M. Salimi, S. Ziaei-Rad, 2008. Parametric study and numerical analysis of empty and foam-filled thin-walled tubes under static and dynamic loadings, International Journal of Mechanical Science. 50: pp 1042-1057.