

# Temperature Control of a Shell and Tube Heat Exchanger using PID Algorithms

Satheesh babu.R<sup>1</sup> Dr.I.Thirunavukkarasu<sup>2\*</sup> Dr.V.I.George<sup>3</sup> Dr.Shreesha.C<sup>4</sup>

**Abstract:-** Integral windup problem and its accommodation in the field of process control, especially for the PID controllers has been under discussion for nearly about five decades (Since 1960) with limited structures and modifications in it. In this paper two control methodologies are analyzed mainly focusing on the control effort reduction under various uncertainties of a process. Also as a case study the Internal Model Control (IMC) and  $M_s$  based Two Degrees of Freedom (2DOF) PID controllers were designed and implemented for a shell and tube heat exchanger using MATLAB® in the lab environment.

## 1. INTRODUCTION

The majority of the regulatory loops in the process industries use conventional Proportional-Integral-Derivative (PID) controllers. Although the use of linear models for the PID controller tuning makes the tuning process easy, the conventional PID is efficient only for a limited operating range. The systems with non-linear characteristics and long time delay are difficult to control using classical methods. A robust/non-linear control technique is sought after since there have been persistent difficulties due to ineffective control methodology applied to these non-linear plants. The present control techniques applied to non-linear plants are linear in nature which causes compromise in terms of performance and stability. As a result an erroneous control over the plant is observed. This poses as a threat to the effective functioning of the plant and thereby a requirement arises of a control methodology which is effective upon these uncertain/non-linear plants.

The objective of this paper is to identify the parameters of the non-linear system and to design and implement a simple Internal Model Control structure, to obtain effective control. Further a maximum sensitivity ( $M_s$ ) based approach for simple robust controller tuning is also proposed to a shell and tube heat exchanger aiming good stability against the uncertainty. There are some controller tunings proposed for the heat exchanger [1-3] but they are not focused on the controller effort/ integral windup issues.

## II. SHELL AND TUBE HEAT EXCHANGER TEMPERATURE PROCESS



Fig.1. Heat Exchanger Physical experimentation experimental setup

Table.1. Technical Specifications of the Heat Exchanger Setup

Type	Shell and Tube
Shell material	SS 316
Tube material	Copper
Tube length	750 mm
Shell diameter	150 mm
Number of tubes	37
Tubes diameter	6 mm

Many industrial processes are modeled by the first-order plus dead time (FOPDT) transfer function  $G_p(s) = \frac{K}{Ts + 1} e^{-\tau s}$ ,

where K is the system gain; T is the time constant and  $\tau$  is the process dead time. 2-point method is used to obtain the parameters of the transfer function of the process. The method proposed by Sundarsen and Krishnaswamy (1978) is used respectively to estimate the time delay. From the times  $t_1$ ,  $t_2$  corresponding to reach 35.3 % and 85.3 % of final steady state value, the time constant and time delay of process are calculated as  $T = 1.3t_1 - 0.29t_2$  and  $\tau = 0.67(t_2 - t_1)$ .

## III Closed Loop Control Algorithm

### A. $M_s$ BASED PI CONTROLLER

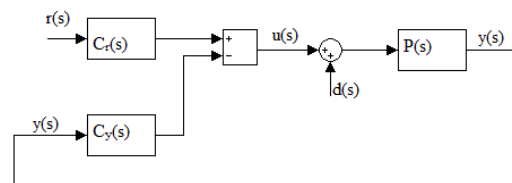

Fig.2. A 2DoF Control System

1-JRF, DST Fast Track Project, Dept. of ICE, MIT, Manipal University, Manipal-India  
 2, 3 & 4 – Associate Professor and Professors, Dept. of ICE, MIT, Manipal University, Manipal-India  
 \*Corresponding author  
 Ph: +91-820-2925152, Fax:+91-820-2571071

Consider a 2-Degrees-of-Freedom (2DoF) feedback control system of Fig. 4 where  $P(s)$  is the controlled process transfer function,  $C_r(s)$  the set-point controller transfer function,  $C_y(s)$  the feedback controller transfer function, and  $r(s)$  the set-point,  $d(s)$  the load-disturbance, and  $y(s)$  the controlled variable. The output of 2-DoF controller is given by

$$U(s) = \underbrace{K_c \left[ \beta + \frac{1}{T_i s} \right]}_{C_r(s)} r(s) - \underbrace{K_c \left[ 1 + \frac{1}{T_i s} \right]}_{C_y(s)} y(s) \quad (1)$$

The closed-loop control system response to a change in any of its inputs, will be given by

$$y(s) = \underbrace{\frac{C_r(s)P(s)}{1 + C_y(s)P(s)}}_{M_{yr}(s)} r(s) + \underbrace{\frac{P(s)}{1 + C_y(s)P(s)}}_{M_{yd}(s)} d(s) \quad (2)$$

Where  $M_{yr}(s)$  is the transfer function from set-point to process variable: the servo-control closed-loop transfer function or complementary sensitivity function  $T(s)$  and  $M_{yd}(s)$  is the one from load-disturbance to process variable: the regulatory control closed-loop transfer function or disturbance sensitivity function  $S_d(s)$ .

As the design is based on a load-disturbance rejection specification, in order to improve the resulting step-response, the available second degree of freedom in the form of a set-point weighting factor will be utilized in the design. The presented procedure can also be applied with any desired degree of robustness level, say for example low, medium and high. This is to say the use of a controller with a minimum acceptable robustness level ( $M_s=2.0$ ), a robust controller ( $M_s=1.6$ ) or a highly robust controller ( $M_s=1.4$ ) could be designed. For the system model in discussion, a robust controller based on the maximum sensitivity approach could be designed. Here a controlled process normalized dead time  $\tau_o$  is defined as the ratio of dead time and the time constant of the system as,

$$\tau_o = \frac{\tau}{T} \quad (3)$$

For the FOPDT process the specified closed-loop transfer function for regulation is chosen as

$$M_{yd} = \frac{K.s.e^{-\tau s}}{(\tau_c.T_d s + 1)^2} \quad (4)$$

and the closed-loop specification for the servo-control is selected as

$$M_{yd} = \frac{e^{-\tau s}}{(\tau_c.T_d s + 1)} \quad (5)$$

Where  $\tau_c$  will be the dimensionless design parameter. It is the ratio of the closed-loop control system time constant to the controlled process time constant. The value of  $\tau_c$  is set to be 0.6 as the controller designed gave the best result. Now the various controller parameters are calculated and a new robust and stable 2-DoF controller is designed. The controller parameters are calculated as:

$$\text{Controller gain, } K_c = \frac{2\tau_c - \tau_c^2 + \tau_o}{(\tau_c + \tau_o)^2} \quad (6)$$

$$\text{Integral time constant, } T_i = \frac{2\tau_c - \tau_c^2 + \tau_o}{1 + \tau_o} \quad (7)$$

Using these parameters the controller was designed but the main objective was to test the robustness. For robust analysis a maximum sensitivity approach has been followed. The maximum sensitivity is represented as

$$M_s = \max_{\omega} |S(j\omega)| = \max_{\omega} \left| \frac{1}{1 + P(j\omega)C_y(j\omega)} \right|$$

This sensitivity function is used as an indication of the closed loop system robustness. It can be deduced from the above mentioned theory that the robustness of a system depends on the values of  $\tau_o$  and  $\tau_c$  only. Since  $\tau_o$  is the normalized dead time parameter and is constant the only tunable parameter here is the  $\tau_c$ . According to the tradeoff between the robustness and performance, a lower value of  $\tau_c$  is selected on designer's choice.

It is necessary to verify whether the robustness performance is within its range,  $1.2 < M_s < 2$  and to have a quantified measure on how the normalized dead time parameter affect the robustness level [5].

The resulting controller parameters can be expressed just in the terms of the process controlled normalized dead time  $\tau_o$  as:

High robustness tuning ( $M_s = 1.4$ );

$$K_c = \frac{-0.23\tau_o + 0.64}{\tau_o + 0.16}, T_i = \frac{-0.85\tau_o^2 + 2.1\tau_o + 0.65}{1 + \tau_o}$$

Medium robustness tuning ( $M_s = 1.6$ );

$$K_c = \frac{-0.17\tau_o + 0.74}{\tau_o + 0.16}, T_i = \frac{-0.44\tau_o^2 + 1.85\tau_o + 0.6}{1 + \tau_o}$$

Low robustness tuning ( $M_s = 2$ );

$$K_c = \frac{-0.1\tau_o + 0.86}{\tau_o + 0.15}, T_i = \frac{1.12\tau_o + 0.16}{\tau_o + 0.37}$$

The controller was designed using the new controller parameters and the robustness level for various values of  $M_s$  is compared.

Using pade approximation the plant can be represented as

$$P(s) = \frac{-704897s + 0.4905}{54112.56s^2 + 520.25s + 1} \quad (8)$$

The Bode plot's peak value gives the magnitude of the  $M_s$  and it is 1.41. As mentioned earlier, this value of  $M_s$  suggests a very high level of robustness and thus justifies that the controller designed is highly robust.

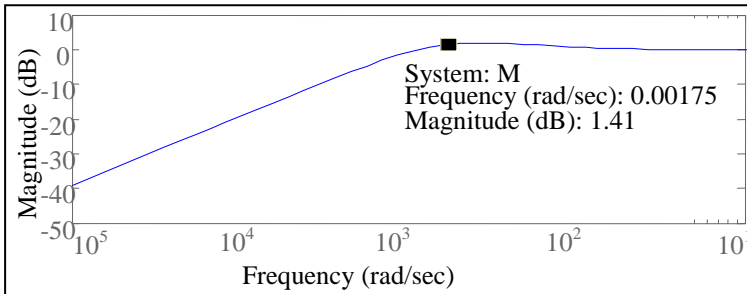

Fig.3. Bode Plot for the closed loop control System

In the proposed 2DoF PID controller the robustness is checked by adding the uncertainty in the process gain and time constant. In this case the process gain is changed to 1 and the original time constant is increased by a factor of 50 and checked for the closed loop performance with the 2DoF PID controller. For the proposed uncertainty in the process controller closed loop performance was analyzed for three different robustness value namely high( $M_s = 1.4$ ), medium( $M_s = 1.6$ ) and low( $M_s = 2.0$ ).

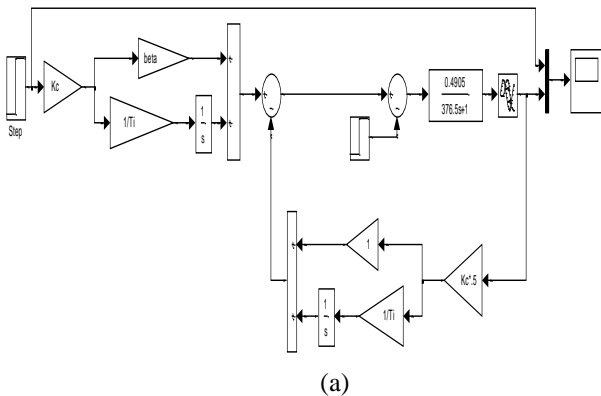

Fig.4

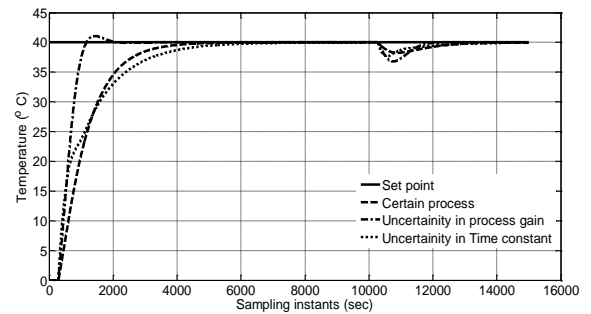

Fig.5(b)

Fig.4(a) and Fig.4(b) shows the Simulink block diagram and its servo response for a 2DoF PI Controller for a Heat Exchanger model with various uncertainty in process parameters with the controller parameters as  $\beta = 0.8556$ ,  $K_c = 1.3535$ ;  $T_i = 374.7976$ .

Table.2. Comparison of ISE and IAE performance indices for the propose 2DoF PI and PI controller.

	2DOF PI		PID	
	ISE	IAE	ISE	IAE
Certain	1.231e5	4.733e4	6.899e5	2.823e4
Gain uncertainty	1.028e6	4.732e4	3.513e11	2.897e7
Time constant uncertainty	1.028e6		9.927e10	1.617e7

Table.2 justifies that the proposed 2DoF PI controller provides better performance in servo and regulatory mode comparative to the simple Z-N PI controller with respect to Integral Square Error and Integral Absolute Error minimization.

Also the performance indices are calculated for the original plant (Certain) and also with the perturbation (Uncertainty) in the process gain ( $K$ ) and time constant ( $\tau$ ) of the process. Table.2. shows that the proposed 2DOF PI controller gives least ISE and IAE values even in the presence of the uncertainty in the process.

#### IV. ANALYSIS OF THE PHYSICAL EXPERIMENTATI ON RESULTS

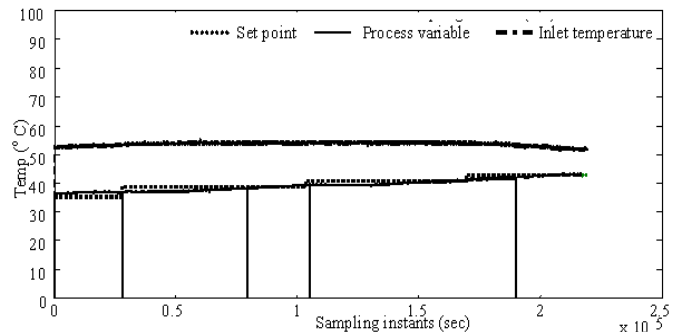

Fig.6. Manipulated Variable of IMC

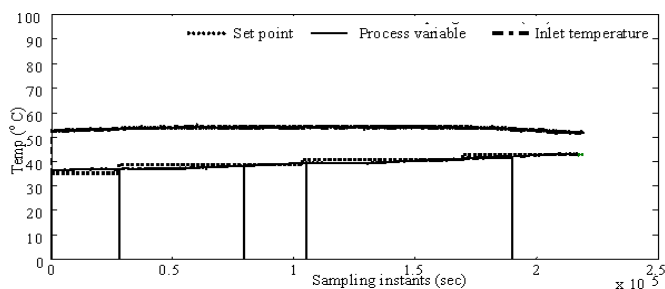

Fig.6. Closed loop tracking response of IMC

Fig.6 and Fig.7 shows the real time results of implementation of Internal Model Controller designed on heat exchanger. The observation made in the Fig.9 is that the controller output(Manipulated variable) moves from 0% to 100% when the process variable reaches the setpoint. In the case study the manipulated variable(MV) is the cold water flow which is opened to the maximum(100%) to take away the excess heat in order to maintain the process variable at the setpoint. Since the MV moves from 0% to 100% it may go to saturation easily (Integral windup will happen at this point of operation). Hence an alternate control algorithm is needed to avoid the integral windup.

Fig.6 shows the servo response of the temperature process with various setpoint. The setpoint was initially kept at 35°C and it was changed by 3 °C. As clearly seen in the graph of Fig.7, when the process variable is below the set-point the control valve action is set to 100 which means fully closed. This implies no cold water flows into the heat exchanger. As the process variable approaches the set-point the control valve opens and cold water flows into shell to carry away the excess heat. After achieving the steady state error the set-point was increased by another 3 °C and the outlet temperature was allowed to settle at the new set-point.

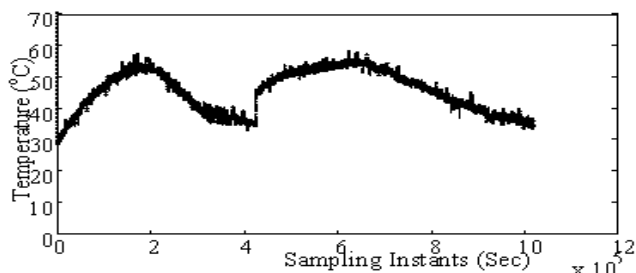

Fig.8. Manipulated variable of  $M_s$  based 2Dof PI Controller

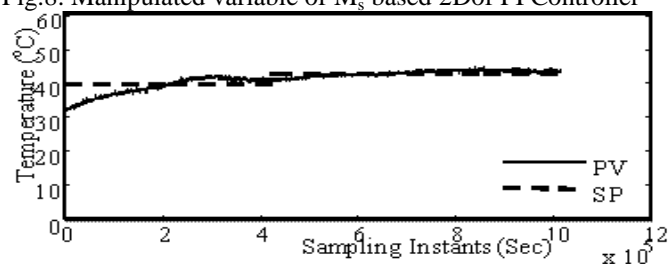

Fig.9. Heat Exchanger servo response with the  $M_s$  based 2Dof PI Controller

Fig. 8 and Fig.9 shows the physical experimentation results of the shell and tube heat exchanger for the  $M_s$  based 2DoF PI controller.

Fig.9 shows the manipulated variable of the  $M_s$  based 2DoF PI controller and it shows clearly that the effort made by the proposed controller is comparatively lesser than the controller effort made by the IMC to maintain the process at desired setpoint. Hence the antireset windup problem can be avoided with the  $M_s$  based 2DoF PID controller.

Fig.9 shows the closed loop response of the temperature process with various setpoint change achieving zero steady state error.

## V. CONCLUSION

In this paper, a shell and tube heat exchanger temperature process has been modeled as a first order with dead time process based on the famous two point method. The IMC and 2DoF PI control algorithms are designed for the identified model and simulated for the stable closed loop response with the MATLAB Simulink platform. The experimentation results of IMC and 2DoF PI controller are presented and analyzed with respect to the physical experimentation manipulated variable and servo response graphs. During the design and implementation of an IMC controller, it is observed that the manipulated variable (controller effort) varies between the minimum and the maximum value (i.e. 0% to 100%). Hence an alternative control algorithm is needed which takes lesser controller action to maintain the process variable at desired setpoint irrespective of the set point changes. It was observed that the  $M_s$  based 2DoF PI controller gives the best result in the servo mode comparative to the IMC. As apparent from the results the controller effort was drastically reduced and maintained between 30% and 60% comparative to the IMC where the controller effort is in between 0% to 100%. The proposed method can also be extended to the counter current operation of shell and tube heat exchanger and also to a conical tank level process station.

Most of the discussions and proposed remedies are held up only with the literature, but implementation of those in the process industries is going to make the research effective and meaningful. The authors have taken some initiative to work under Academia-Industry Research Collaborations in the above said area and the same is under progress with process industries near by the institute/university.

**Acknowledgement:** The authors would like to thank DST, Government of India for funding the fast track project wide circular #SB/FTP/ETA-0308/2012 Dated May, 25, 2013. The authors also would like to thank MIT, Manipal University for



providing the infrastructure facility for carrying out this Project.

## REFERENCES

- [1] NithyaVenkatesan, N. Sivakumaran, P. Sivashanmuguhan : “Experimental Study of Temperature Control using soft computing.”, International Journal of Computer Application (0975-8887) Volume 52 – No. 9 , August 2012
- [2] YuvrajBhushanKhare, Yaduvir Singh: “PID Control of Heat Exchanger System”International Journal of Computer Application (0975-8887) Volume 8 – No. 6, October 2010
- [3] S Nithya, Abhay Singh Gour, N Sivakumaran, T.K. Radhakrishnan, T Balasubramanian and N Anantharaman: “ Design of Intelligent Controller For Non Linear Process” , Asian Journal Of Applied Sciences 1 (1): 33-45, 2008 ISSN 1996-3343
- [4] Donald Coughanowr, “Process System Analysis and Control”, Page no. 272- 281, Third Edition, McGraw Hill’s publications
- [5] R. Vilanova, V. Alfaro, O. Arrieta: “  $M_s$  based approach for simple robust PI controller design” , Proceedings of the International Multi-conference of Engineers and Computer Scientists(IMECS) March 2011Vol II, Hong Kong
- [6] P.Sivakumar et al, “Temperature Control of Shell and Tube Heat Exchanger by Using Intelligent Controllers-Case Study”, International Journal Of Computational Engineering Research ,Vol. 2 Issue. 8, Dec. 2012. P. No: 285-291.
- [7] S.Rajasekaran et al, “A Simplified Predictive Control For A Shell And Tube Heat Exchanger”, International Journal of Engineering Science and Technology, Vol. 2 (12), 2010, P. No. 7245-725.



Mr.Satheeshbabu.R, Junior Research Fellow in a DST-Fast Track Project, Department of Instrumentation and Control Engg., MIT, Manipal University, India. His area of interest is in Process Control.



Dr.I.Thirunavukkarasu, Associate Professor, Department of Instrumentation and Control Engg., MIT, Manipal University, India. He is an IEEE member and member in various professional bodies. His area of interest is in Advanced Process



Dr.V.I.George, Professor, Department of Instrumentation and Control Engg., MIT, Manipal University, India. He is an IEEE member. His area of interest is in Aerospace, Robust Control. He is a senior member in IEEE and fellow in Institution of Engineers (India)



Dr.Shresha.C, Professor and Head, Department of Instrumentation and Control Engg., MIT, Manipal University, India. His area of interest is in Advanced Control Systems, System Identification of Non-Linear systems. He is a fellow in Institution of Engineers(India).