

Fault diagnosis for Photo-Voltaic Power Converter based on Model Observers

Zhaohui Cen, Abdelkader Bousseham

Abstract—As a key part of Photo-Voltaic (PV) power system, the power converters are easy to degrade and age because of its uninterrupted operations and instability of PV power output, it is essential to monitor conditions of the power converters and diagnosis faults in real-time to avoid fatal failures and improve the reliability. In this paper, a novel model-observer is proposed to monitor the states of power converters, and diagnosis component faults. Residual vectors generated from the proposed model observer can be used for fault detection and isolation. Finally, simulations on the PV buck converter are performed to test and validate the effectiveness of the proposed method.

Keywords—Fault diagnosis, Photo-Voltaic, model observer, buck converter

I. Introduction

As a key part of Photo-Voltaic (PV) power system, power converters have important functions such as DC-DC conversions and DC-AC inversions to feed power into local loads or power grids. However, the power converters are also easy to degrade and age because of its uninterrupted operations and instability of PV power output [1–3]. Therefore, it is essential to monitor conditions of the PV module-level power converters and further diagnosis faults in real-time or in advance to avoid fatal failures and improve the reliability of overall power system.

Currently, most of reliability researches on power converters are contributed on fault mechanism analysis, characteristic signal analysis and qualitative fault modes identification because of limited measurable state signals. The possible faulty components involved in power electronics can be seen in Fig.1 of [4], [5]. The pie chart shows that capacitors are the most components of power electronics which are easy subjected to failures. Also, semiconductor components such as MOSFET and IGBT have a large proportion of failure distributions. Aimed on these faults in power electronics, some diagnostic techniques based on converter terminal quantities such as output voltage frequency analysis, motor stator current time-domain response, the current vector trajectory in the Concordia frame[6–8], are adopted to identify faulty components. However, because these approaches are based on

off-line signal or periodic duration signals, it is not absolutely real-time and mainly depends on complicated artificial fault analysis. Also, some real-time diagnostic techniques based on voltages or currents of power electronics devices is studied in [9], [10], but it is only applicable for faults of switch components such as IGBT and MOSFET. [11], [12] studied on fault diagnosis of power inverters based on artificial intelligence methods such as artificial neural networks (NN), these approaches can be used to diagnosis typical components faults based on the measured voltage and current signals. However, it is only applicable for specified faults and device conditions. Also, because the NN need to be trained first based on its sample data from the historical fault-free and faulty signal, the diagnosis efficiency closely depends on the diversity of sample data signals.

The contribution work of this paper is to monitor and diagnosis the power converters in real-time. Residual vectors generated from the proposed model observer can be used for fault detection and isolation. Unlike former reliability approaches applied in power electronics, it can not only detect the power converter system in real-time, but also diagnosis its components, which is useful for isolating the faulty components of power system and improving the reliability and efficiency of PV system with power grid integration.

This paper is organized as follows. In Section 2, the mathematical model of a buck power converter and condition monitoring & fault diagnosis are elaborated. The model observers for fault diagnosis is proposed in Section 3. Section 4 is devoted to the presentation of the simulation results obtained for various fault components and fault scenarios when the proposed scheme is applied to the buck power converter. Finally, conclusion is provided in Section 5.

II. Model framework and problem formulation

Because of its representativeness and popularization in PV power system, a single-phase DC-DC buck converter in Fig.1 is considered to build the model and hardware in this paper.

A. Single-phase buck converter with resistor load

Consider the single-phase DC-DC power converter in Fig. 2 and 3, comprised of a semiconductor switch Q, an inductor L, a capacitor C, a diode D and a resistor Load R. The basic operation of the buck converter has the current in an inductor controlled by two switches (the transistor Q and the diode D). The conceptual model of the buck converter is best understood in terms of the relation between current and voltage of the inductor. Therefore, a power electronics converter can be

Zhaohui Cen
Qatar Environment and Energy Research Institute
Qatar

Abdelkader Bousseham
Qatar Environment and Energy Research Institute
Qatar



thought of as a switched system, i.e., a continuous-time system with discrete (isolated) switching events, and (in general), its dynamics can be described by a linear-switched state-space model of the form.

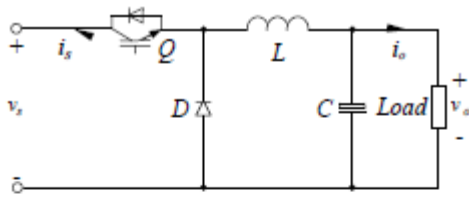

Fig. 1 Topology of Buck converter

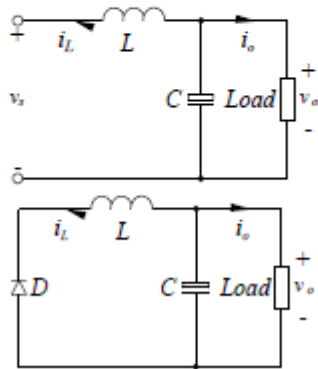

Fig. 1 Buck converter in charging Mode (upper) and Buck converter in discharging (lower)

The nominal (Pre-Fault) system state-space model of buck converter can be denoted as:

$$\begin{bmatrix} \dot{I}_L \\ \dot{U}_o \end{bmatrix} = \begin{bmatrix} 0 & -\frac{1}{L} \\ \frac{1}{C} & -\frac{1}{RC} \end{bmatrix} \begin{bmatrix} I_L \\ U_o \end{bmatrix} + \begin{bmatrix} \sigma(t)/L \\ 0 \end{bmatrix} U_i$$

$$\begin{bmatrix} I_L^m \\ U_o^m \end{bmatrix} = \begin{bmatrix} 1 & 0 \\ 0 & 1 \end{bmatrix} \begin{bmatrix} I_L \\ U_o \end{bmatrix}$$

where L is the inductance of the inductor, C is the capacitance of the capacitor, R is the load resistance. $\sigma: [0, \infty) \rightarrow \{0, 1\}$ is the binary switching signal governing the Switch Q. The description in **Error! Reference source not found.** can be completed with $y = [I_L^m \ U_o^m]^T = C'x$, where $C' = I_{2 \times 2}$

and $x = [I_L \ U_o]^T$, describing the measurements available to the controller. Also, we can denote **Error! Reference source not found.** as the standard format of state-space model $\dot{x} = Ax + Bu, y$ where

$$A = \begin{bmatrix} 0 & -\frac{1}{L} \\ \frac{1}{C} & -\frac{1}{RC} \end{bmatrix}, B = \begin{bmatrix} \sigma(t)/L \\ 0 \end{bmatrix}, u = U_i$$

If a fault or parameters variation has occurred in the system, these factors will cause a change in the matrices of any or all subsystems in **Error! Reference source not found.** Without loss of generality, consider faults in the inductor L and the output filter capacitor C. The faults may cause the inductor or the capacitor to degrade slowly over time, which would result in a gradual decrease in inductance or capacitance (soft fault), or it may cause a sudden failure open or short (hard fault). Thus, the variation caused by fault can be denoted as $\hat{A} = A + \Delta A$ and $\hat{B} = B + \Delta B$. Also, the condition parameters of buck converter can be denoted as $\theta = [L \ C]^T$. So, the post-fault system Model can be described by

$$\begin{bmatrix} \dot{I}_L \\ \dot{U}_o \end{bmatrix} = \begin{bmatrix} 0 & -\frac{1}{L + \Delta L} \\ \frac{1}{C + \Delta C} & -\frac{1}{R(C + \Delta C)} \end{bmatrix} \begin{bmatrix} I_L \\ U_o \end{bmatrix} + \begin{bmatrix} \sigma(t)/(L + \Delta L) \\ 0 \end{bmatrix} U_i$$

(2)

It can also described in the format of state space model as

$$\begin{aligned} \dot{x} &= (A + \Delta A)x + (B + \Delta B)u \\ y &= C'x \end{aligned}$$

(3)

Fault diagnosis problem formulation

Consider **Error! Reference source not found.**, the fault diagnosis problem consists of designing a detection filter that takes u and y as inputs and generates a residual vector with the following properties: i) when there is no fault, the residual is identical to zero, and ii) when a fault occurs, the residual is clear enough to differ different faults from the capacitor, inductor and switch.

III. Fault diagnosis observer

Following the notation of section 2, a fault diagnosis observer for the system in **Error! Reference source not found.** is given by

$$\begin{bmatrix} \dot{\hat{I}} \\ \dot{\hat{U}}_o \end{bmatrix} = \begin{bmatrix} 0 & -\frac{1}{L} \\ \frac{1}{C} & -\frac{1}{RC} \end{bmatrix} \begin{bmatrix} \hat{I}_L \\ \hat{U}_o \end{bmatrix} + \begin{bmatrix} \sigma(t)/L \\ 0 \end{bmatrix} U_i + K \left(y - C' \begin{bmatrix} \hat{I}_L \\ \hat{U}_o \end{bmatrix} \right)$$

(4)

where $\sigma(t)$, U_i , y are same as in (1). Also, it can be represented as

$$\begin{aligned} \dot{\hat{x}} &= A\hat{x} + Bu + K(y - \hat{y}) \\ \hat{y} &= C'\hat{x} \end{aligned}$$

(5)

Although $C' = I_{2 \times 2}$ and the system of **Error! Reference source not found.** has full rank, the system is only theoretically observable when $\sigma(t) = 1$, otherwise it is not

observable. In order to guarantee that the observability property is preserved, it is necessary to consider $\sigma(t)$ as a regularly persistent input. So, the error dynamics $\dot{e} = A - \hat{A}$ can be defined as:

$$\dot{e} = (A - KC)e \quad (1)$$

A further theorem based on analysis above is given below.

Theorem 1: If there exist a certain symmetric positive definite

matrix $P \in \mathbb{R}^{2 \times 2}, P = P^T$ and some $\rho \in \mathbb{R}_{>0}$, the LMI below is satisfied,

$$(A - KC)^T P + P(A - KC) < -\rho P \quad (2)$$

Then the error dynamics (1) is globally asymptotically stable.

The proof of this theorem can be referred to theorem 4.4 in [13]. The solution of the inequality (2) can be got from the following lemma 2.

Lemma 2: If there exist a certain symmetric positive definite matrix $P \in \mathbb{R}^{2 \times 2}, P = P^T$ and some $\rho \in \mathbb{R}_{>0}, \rho \in \mathbb{R}_{>0}$, the LMI below is satisfied,

$$(PA - YC)^T + (PA - YC) < -\rho P \quad (3)$$

Then the inequality (2) is satisfied with P and by taking $L = P^{-1}Y$.

The proof of the lemma 2 can be referred to lemma 4.5 in [13].

Remark: based on the residuals $e = x - \hat{x}$ generated by the fault diagnosis observer, fault detection and fault isolation can be implemented based on the time-domain property of the residual signal, which is further demonstrated in section 4.

IV. Simulation results

In order to verify the feasibility and effectiveness of the proposed observers, a DC-DC converter with parameters listed in Table 1 is designed for verification. Firstly, different component faults are injected into the buck converter and the corresponding FDD results are analyzed. Secondly, the variable inductance fault and capacitance fault are respectively injected into the buck converter and the inductance and capacitance estimation results are analyzed. Finally, a mixed fault scenario with parameters drifts of both inductance and capacitance is performed and the corresponding parameter estimation results are discussed.

Table 1 buck converter parameters

$R[\Omega]$	7	$V_{in}[V]$	20
$L[H]$	5×10^{-4}	$V_{out}[V]$	8
$C[F]$	5.8×10^{-5}	$i_{out}[A]$	8/7
$F[kHz]$	10	PWM Duty ratio	0.4

The fault diagnosis observer is firstly used to detect and isolate the different component faults based on the residuals. In order to make the residual signals be clear enough to differ faults, the FD observer gain K is set as

$$K = \begin{bmatrix} 1 & 0 \\ 0 & 1 \end{bmatrix} \quad (4)$$

The states variables, estimate and residuals of the buck converter in fault-free mode can be seen in Fig. 2 and Fig. 3. As can be seen from Fig. 2, the inductor current displays as a small ripple because of the PWM control's effect, while the output voltage indicates more stable because of the output's filter's smoothing. As can be seen from Fig. 3, the observer estimation can track the system states very closely because of the feedback gain's effect. Also, the residuals converge to zero very quickly, which is useful to detect faults.

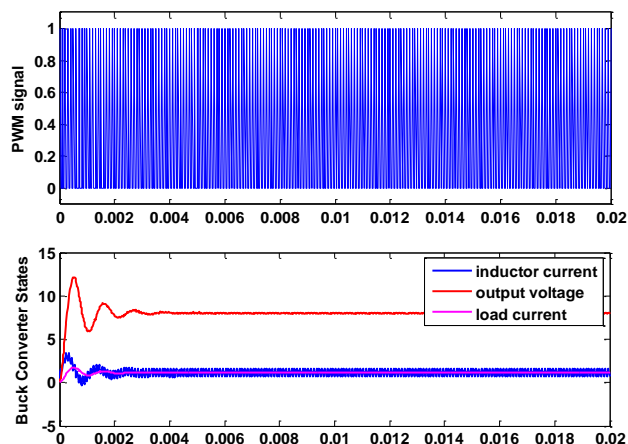

Fig. 2 States of the buck converter in fault-free mode

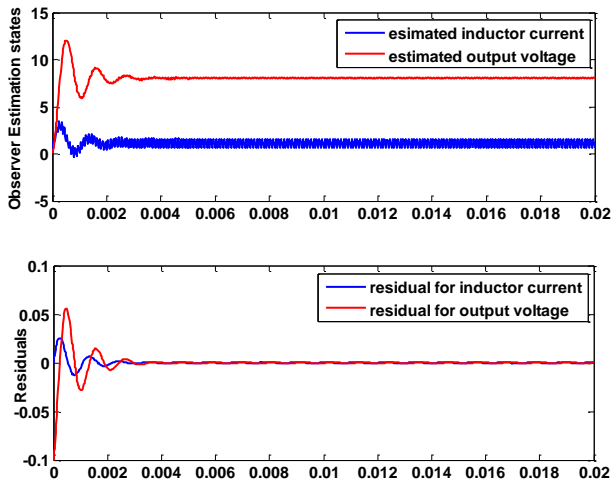

Fig. 3 observer estimation and residuals

The residuals under different fault modes can be seen in Fig. 4, Fig. 5, Fig. 6 and Fig. 7. An open-circuit fault and a Short-circuit fault are respectively injected at the instant 0.05s. A constant capacitance variation from C to 2C is injected at the instant 0.03s; also a constant inductance variation from L to 2L is injected at the instant 0.03s. From the residuals subjected to different faults, we can see that the residuals are no longer zero at the instants when faults occur, and also the fault signatures off different components are different.

Fig. 4 and Fig. 5 depict the residuals under switch faults. It is obviously clear that open-circuit fault and short-circuit fault have different effects on the residuals. Fig. 6 and Fig. 7 depict the residuals under capacitor and inductor faults. It is obviously clear that capacitor fault and inductor fault have different effects on the residuals. The residuals are also easy to differ from the residuals under the switch Q faults.

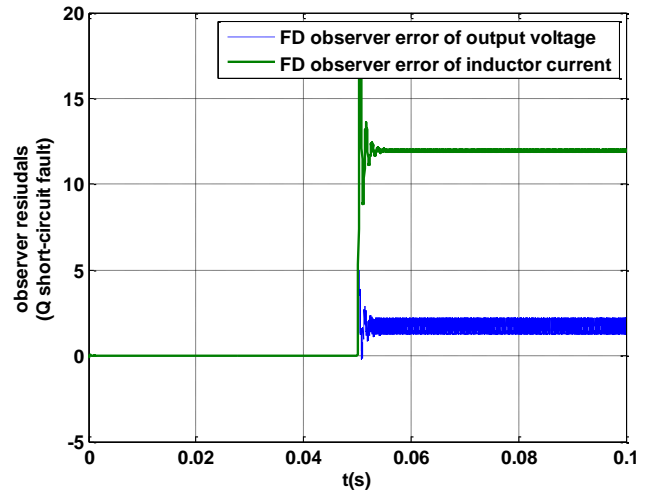

Fig. 5 residuals under switch Q short-circuit fault

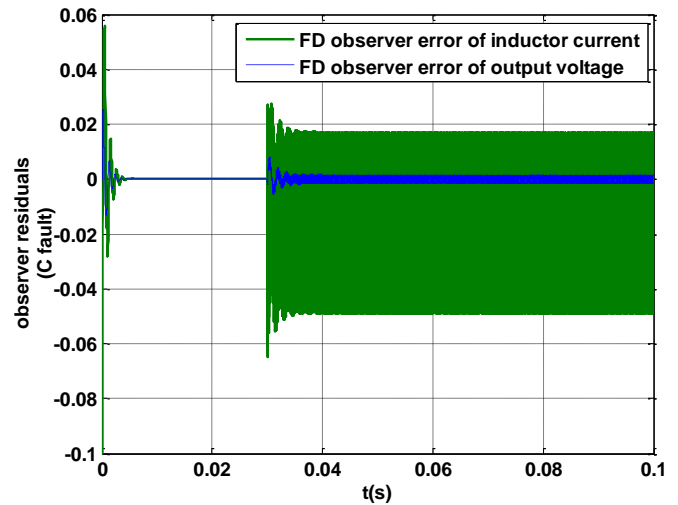

Fig. 6 residuals under capacitor fault

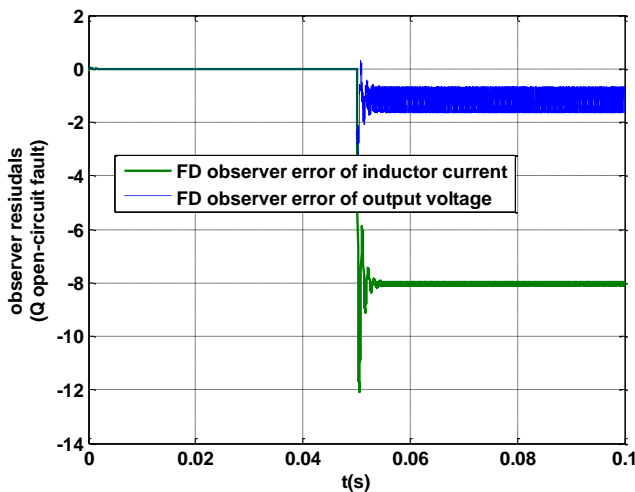

Fig. 4 residuals under switch Q open-circuit fault

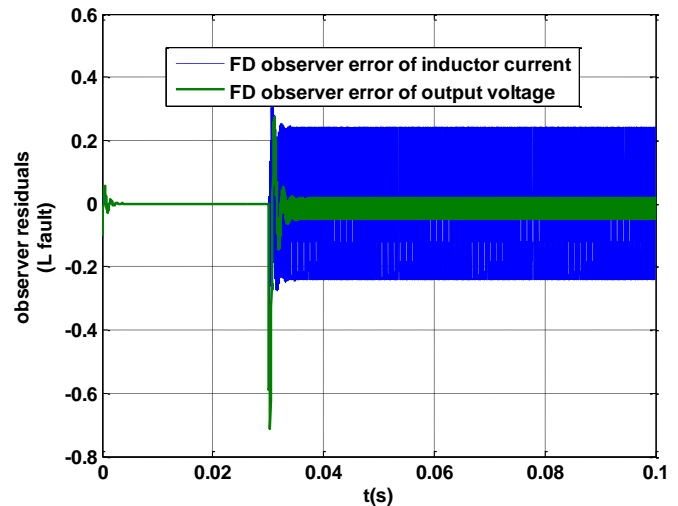

Fig. 7 residuals under inductor fault

v. Conclusions

This paper proposes a condition parameter estimation scheme based on model observers for a type of PV buck converter. With the FD observer, Fault detection and isolation for components can be available based on the residual signals. A further power electronics hardware demonstration based on NI compact RIO is on-going. Future work will consider more converters applied in PV system such as boost and other inverters.

Reference

- [1] S. Dhople, "A unified approach to reliability assessment of multiphase DC-DC converters in photovoltaic energy conversion systems," *Power Electronics*, ..., 2012.
- [2] S. Dhople and A. Davoudi, "Reliability assessment of fault-tolerant Dc-Dc converters for photovoltaic applications," ... and Exposition, 2009 ..., 2009.
- [3] S. V Dhople and S. Member, "Estimation of photovoltaic system reliability and performance metrics," *Power Systems, IEEE* ..., vol. 27, no. 1, pp. 1-10, 2012.
- [4] H. Wang, K. Ma, and F. Blaabjerg, "Design for reliability of power electronic systems," *IECON 2012 - 38th Annual Conference on IEEE Industrial Electronics Society*, pp. 33-44, Oct. 2012.
- [5] F. Blaabjerg, K. Ma, and D. Zhou, "Power electronics and reliability in renewable energy systems," *2012 IEEE International Symposium on Industrial Electronics*, pp. 19-30, May 2012.
- [6] P. Lezana, J. Pou, T. A. Meynard, J. Rodriguez, S. Member, S. Ceballos, S. Member, and F. Richardeau, "Survey on Fault Operation on Multilevel Inverters," vol. 57, no. 7, pp. 2207-2218, 2010.
- [7] Y. Song, B. Wang, and S. Member, "Survey on Reliability of Power Electronic Systems," vol. 28, no. 1, pp. 591-604, 2013.
- [8] X. Yu, S. Member, A. M. Khambadkone, and S. Member, "Reliability Analysis and Cost Optimization of Parallel-Inverter System," vol. 59, no. 10, pp. 3881-3889, 2012.
- [9] [Y. XIONG, "MODELING AND ANALYSIS OF POWER MOSFETS FOR HIGH FREQUENCY DC-DC CONVERTERS," the University of Central Florida, 2008.
- [10] Y. Xiong, S. Member, X. Cheng, Z. J. Shen, S. Member, C. Mi, H. Wu, and V. K. Garg, "Prognostic and Warning System for Power-Electronic Modules in Electric , Hybrid Electric , and Fuel-Cell Vehicles," *IEEE TRANSACTIONS ON INDUSTRIAL ELECTRONICS*, vol. 55, no. 6, pp. 2268-2276, 2008.
- [11] [S. Khomfoi, S. Member, L. M. Tolbert, and S. Member, "Fault Diagnostic System for a Multilevel Inverter Using a Neural Network," vol. 22, no. 3, pp. 1062-1069, 2007.
- [12] [S. Khomfoi, L. M. Tolbert, and S. Member, "Fault Diagnosis and Reconfiguration for Multilevel Inverter Drive Using AI-Based Techniques," vol. 54, no. 6, pp. 2954-2968, 2007.
- [13] [V. Spinu, M. Dam, and M. Lazar, "Observer design for DC / DC power converters with bilinear averaged model," no. Adhs 12, pp. 4-9, 2012.

About Author (s):



Dr. Cen's research interest is in the field of measurement and control, and his current research at QEERI focuses on Smart Microgrid for Renewable Energy Integration based on power electronics and embedded system technologies.