

A Low-Rate Wireless Spread-Spectrum Communication Technique using Linear Step FM Signal

Yih-Min Chen

Abstract—A low data-rate communication technique using linear step frequency modulated (LSFM) signal is presented. When the carrier frequency offset (CFO) between the transmitter and the receiver is significant comparing to the symbol rate, the techniques using normal signaling waveforms with matched filtering become infeasible. In this scenario, wideband chirp (linear FM) signal is feasible because of its favorable characteristics in ambiguity function. However the fully digital implementation of the matched filter for the chirp signal is not economic. In this paper, we propose the use of a linear step FM signal, which has similar characteristics as a chirp signal, and an efficient hardware structure in the digital implementation of the corresponding matched filter.

Keywords—Chirp, Linear Step FM, Low-Rate

I. Introduction

Wireless communication techniques have been evolving at an exceptional rate recently and will be continually in the near future. Although the mainstream techniques are broadband wireless communications which satisfy the demand of mobile internet services, there are low data-rate techniques due to the growing needs of wireless sensor networks deployment [1]. In a low-rate wireless personal area network (LR-WPAN) standard (IEEE 802.15.4a), the chirp spread-spectrum (CSS) signals are used to support long-range links between sensor nodes.

A chirp signal, also known as linear frequency modulated (LFM) signal, is a sinusoidal signal whose frequency increases or decreases linearly over a certain time span. Traditionally this signal is used in radar/sonar applications due to its special characteristics in ambiguity function, i.e., pulse compression and Doppler shift immunity. Recently the well-known pulse compression characteristics of the chirp signal has been exploited in communications mainly for immunity against multipath/interference or multiple access purposes [2-8]. The generation of the transmitted chirp signals and the matched filtering in the receiver are mainly relied on the analog surface acoustic wave (SAW) chirped delay lines [9-10]. Due to the rapid development the flexibility in the digital technology, a full-digital implementation of the chirp modulator/matched

filter is thus desired. In [10], a full-digital implementation of radar chirp pulse compression using FFT processors is proposed.

When a low-rate/low-power wireless communications in a relative high RF band is desired, normal digital signaling becomes infeasible due to a significant carrier frequency offset (CFO) relative to the symbol rate. Although the wideband chirp communication techniques with long chirp period are adequate in this scenario, the digital implementation of the matched filter is not economic. In this paper, we propose the use of a linear step FM signal, which has similar characteristics as a chirp signal, and an efficient hardware structure in the digital implementation of the corresponding matched filter.

II. Chirp Communications

The baseband signal of a chirp (linear FM) signal can be written as

$$s_{chirp}(t) = \begin{cases} e^{j \cdot 2\pi \frac{\Delta f}{T_{chirp}} \left(t^2 - \frac{T_{chirp}}{2} t \right)}, & 0 \leq t < T_{chirp} \\ 0, & otherwise \end{cases} \quad (1)$$

where Δf denotes the frequency swift range ($-0.5\Delta f \sim 0.5\Delta f$) (chirp span) during the chirp period T_{chirp} . The ambiguity function of a chirp signal can be approximated by

$$|A(\tau_d; f_D)| \approx T_{chirp} \cdot \left(1 - \left| \frac{f_D}{\Delta f} \right| \right) \cdot \text{sinc}(\Delta f \cdot \tau_d - f_D \cdot T_{chirp}) \quad (2)$$

where the ambiguity function of a baseband signal $s_b(t)$ is defined as the time response of a filter matched to the signal when the signal is received with a delay τ_d and a Doppler shift (CFO) f_D given as follows

Yih-Min Chen
 Department of Communication Engineering,
 National Central University, Taiwan

$$A(\tau_d, f_D) = \int_{-\infty}^{\infty} s_B(t) \cdot s_B^*(t - \tau_d) \cdot \exp(j2\pi f_D t) dt \quad (3)$$

The baseband signal of a chirp communication using binary orthogonal keying (BOK) is given as follows

$$s_B(t) = \sum_k s_{a_k}(t - k \cdot T_{sym}) \quad (4)$$

where $s_{a_k}(t) = \begin{cases} s_{chirp}(t), & a_k = 1 \\ s_{chirp}^*(t), & a_k = 0 \end{cases}$, a_k denotes the k th

binary data, and T_{sym} is the symbol period which can be less than T_{chirp} to increase the data rate. The received baseband signal in AWGN channel with CFO \mathcal{F}_C , phase offset θ_C and delay τ_0 is given as

$$r_B(t) = s_B(t - \tau_0) \cdot \exp(j(\mathcal{F}_C t + \theta_C)) + n_B(t) \quad (5)$$

where $n_B(t)$ is the AWGN having a spectral density N_0 . The corresponding non-coherent receiver is shown in Fig. 1.

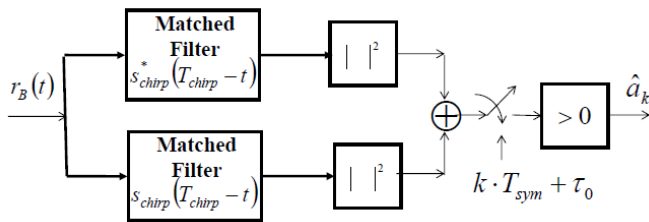

Figure 1. Non-Coherent Receiver of BOK Chirp Communications

III. Digital Communications using Linear Step FM Signal

As shown in Fig. 1, the digital implementation of the matched filter for chirp signals requires an FIR filter with large number of taps or an FFT processor with large size. In order to reduce the complexity of matched filters, we propose a linear step FM signal, which has similar characteristics as a chirp signal, and an efficient hardware structure in the digital implementation of the corresponding matched filter. The

baseband signal of linear step FM (LSFM) signal with a frequency swift range Δf is given as follows,

$$s_{LSFM}(t) = \begin{cases} e^{j\left(2\pi \cdot f_m \left(t - \frac{m \cdot T_{sym}}{M}\right) + \theta_m\right)}, & \frac{m \cdot T_{sym}}{M} \leq t < \frac{(m+1) \cdot T_{sym}}{M} \\ 0, & \text{otherwise} \end{cases} \quad (6)$$

where M ($m = 0 \sim M - 1$) and $f_m = -\frac{\Delta f}{2} + \frac{m \cdot \Delta f}{(M - 1)}$ denote

the number of steps and the instantaneous frequency at the m th step respectively, while θ_m is the phase adjustment for making the signal continual in phase. With an over-sampling ratio (OVSr), i.e., $\frac{T_{sym}}{T_{sam}} = N_M \cdot M$, the sampled baseband is given as follows

$$s_{LSFM}[n] = \begin{cases} e^{j(\omega_{D,m}(n - m \cdot N_M) + \theta_m)}, & m \cdot N_M \leq n < (m+1) \cdot N_M \\ 0, & \text{otherwise} \end{cases} \quad (7)$$

where $\omega_{D,m} = 2\pi \cdot f_m \cdot T_{sam}$. Since the signal at each sub-symbol step is only a constant frequency signal, the corresponding digital matched filter can be efficiently implemented with a structure as shown in Fig. 2, where

$$h_{B,m}[n] = \begin{cases} e^{-j(\omega_{D,m}(N_M - m) + \theta_m)}, & 0 \leq n < N_M \\ 0, & \text{otherwise} \end{cases} \quad (8)$$

is the impulse response of the FIR matched to the signal at the m th step and only three constant multipliers is required for each sub-filter. Therefore the total number of multipliers is $3 \cdot M$ comparing to $N_M \cdot M$ required in the direct implementation of the matched filter for chirp signals.

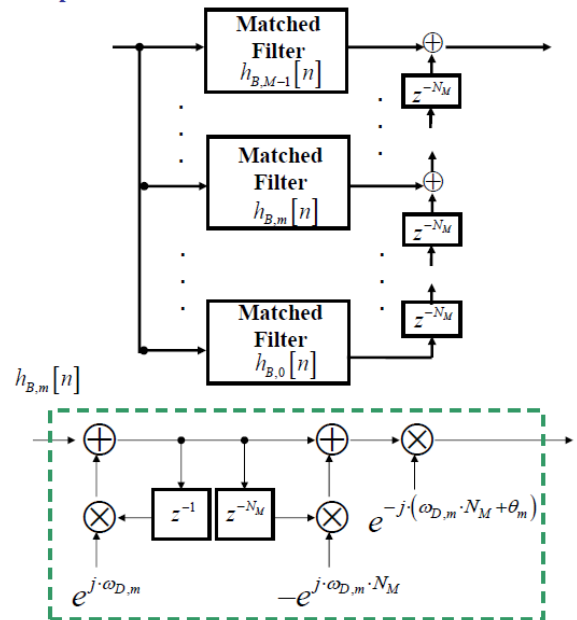

Figure 2 . Efficient Digital Matched Filter Structure for LSFm Signal

IV. Simulation Results

The ambiguity function of a chirp signal is shown in Fig. 3 where the x-axis and y-axis represent the delay and Doppler (CFO) respectively. The ambiguity functions of the proposed LSFM signals with the same chirp period, the chirp span and different frequency steps are shown in Fig. 4-6. With $M=32$, 64, and 128, the sidelobe peaks are -6 dB, -20 dB, and -28 dB, respectively. The sidelobes will cause the ISI, when their locations coincide the symbol period, which can be controlled by adequate selection of the number of frequency steps. The simulated BER performance of BOK using LSFM signals with $\Delta f = f_s/4$ (chirp span), $T_{sym} = 8192/f_s$ (chirp period) ($N = N_M \cdot M = 8192$), $\delta f_c = 10/T_{sym}$ (CFO), and $M = 64$ (number of frequency steps) is shown in Fig. 7, where the signal-to-noise ratio is expressed by E_b/N_0 . For $E_b/N_0 = 10$ dB, the corresponding signal to (transmission) in-band noise power ratio is noticed to be $P_S/P_N = E_b/N_0 \cdot \frac{4}{N} = -23$ dB due to the wideband characteristic of the low-rate signaling.

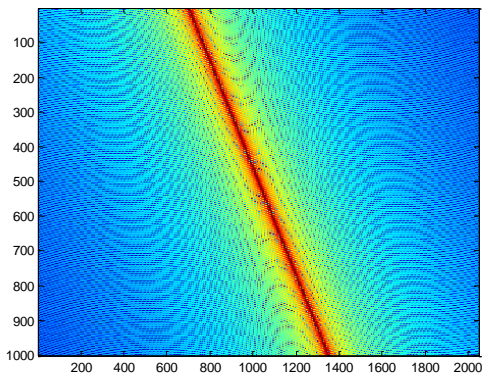

Figure 3. Ambiguity function of a Chirp signal

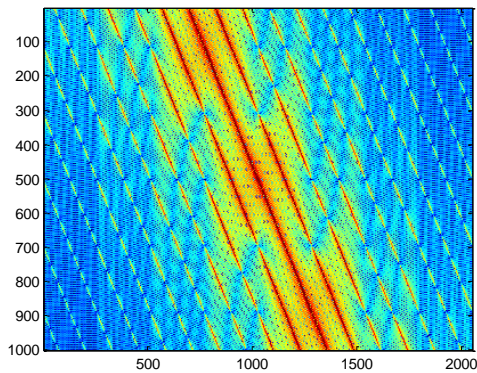

Figure 4. Ambiguity function of a Linear Step FM signal ($M=32, N_M=256$, Peak Sidelobe=-6 dB)

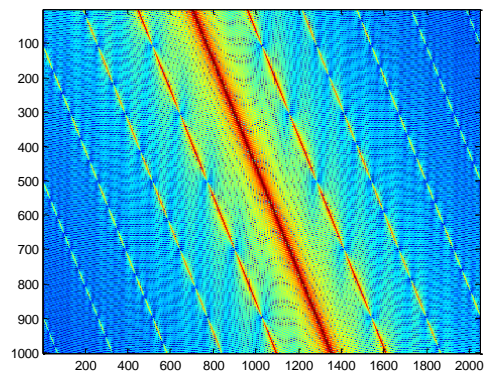

Figure 5. Ambiguity function of a Linear Step FM signal ($M=64, N_M=128$, Peak Sidelobe=-20 dB)

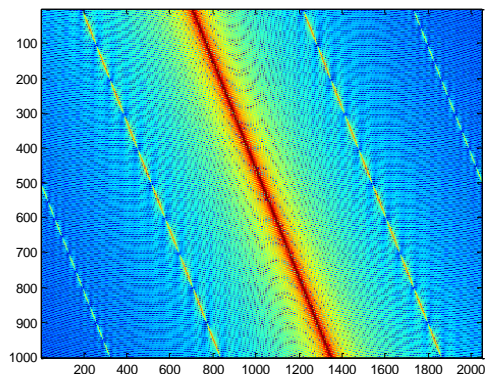

Figure 6. Ambiguity function of a Linear Step FM signal ($M=128, N_M=64$, Peak Sidelobe=-28 dB)

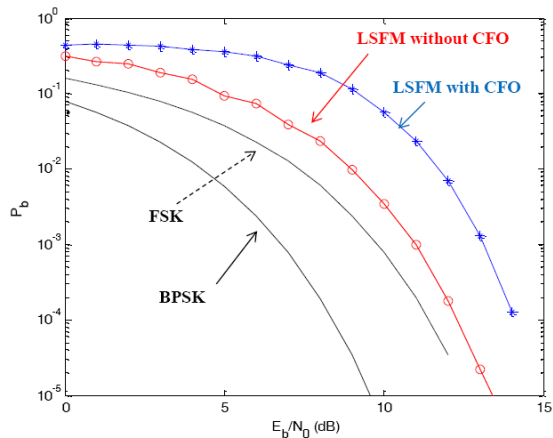

Figure 7. simulated BER performance of BOK using LSFM signals with $\Delta f = f_s/4$ (chirp span), $T_{sym} = 8192/f_s$ (chirp period) ($N = N_M \cdot M = 8192$), $\delta f_c = 10/T_{sym}$ (CFO), and $M = 64$ (number of frequency steps)

v. Conclusion

Communication techniques using wideband chirp signals are feasible for a low-rate/low-power wireless communications with significant CFO. However, the digital implementation of the corresponding matched filter is not economic. relative to the symbol rate. In this paper, we propose the use of a linear step FM signal, which has similar characteristics as a chirp signal, and an efficient hardware structure in the digital implementation of the corresponding matched filter.

References

- [1] E. Karapistoli, F. Pavlidou, I. Gragopoulos, and I. Tsetsinas, "An Overview of the IEEE 802.154a Standard," IEEE Communications Magazine, Jan. 2010.
- [2] H. Shen, S. Machineni, C. Gupta, and A. Papandreou-Suppappola, "Time-Varying Multichirp Rate Modulation for Multiple Access Systems," IEEE Signal Processing Letters, vol. 11, pp. 497–500, May 2004.
- [3] L. M. Dao, Wireless Communications Using Chirp Signals, Master Thesis, Waseda University, Japan, 2008..
- [4] Y. Takeuchi and K. Yamanouchi, "A Chirp Spread Spectrum DPSK Modulator and Demodulator for Time Shift Multiple Access Communication System by using SAW Devices," IEEE MTT-S Microwave Symposium Digest, 1998.
- [5] W. Gugler, A. Springer, and R. Weigel, "A Chirp-Based Wideband Spread Spectrum Modulation Tecnique for WLAN Applications," IEEE 6th International Symposium on Spread Spectrum Techniques and Applications, 2000.
- [6] M. Khan, R. Rao, K, and X. Wang, "Non-Linear Trigonometric and Hyperbolic Chirps in Multiuser Spread Spectrum Communication Systems," IEEE 9th International Conference on Emerging Technologies, 2013..
- [7] C. He, J. Huang, Q. Zhang, and K. Lei, "Reliable Mobile Underwater Wireless Communication Using Wideband Chirp Signal," International Confereence on Communications and Mobile Computing, 2009.
- [8] H. Liu, "Multicode Ultra-Wideband Scheme Using Chirp Waveform," IEEE Journal on Selected Areas in Communications, vol. 24, pp. 885-891, April 2006.
- [9] A. Springer, M. Huemer, L. Reindle, C. Ruppel, A. Pohl, F. Seifert, W. Gugler, and R. Weigel, "A Rubuster Ultra Broadband Wireless Communication System Using SAW Chirped Delay Lines," IEEE Trans. on Mircowave Theory and Techniques, vol. 46, pp. 2213-2219, Dec. 1998.
- [10] P. Torroli, F. Guidi, and C. Atzeni, "Digital vs. SAW Matched Filter Implementation for Radar Pulse Compression," IEEE Ultrasonic Symposium Proceedings , pp. 199-202, 1994.