

UCGVision: Underground Coal Gasification Process Data Visualization Aspects

Karolina Nurzyńska, Sebastian Iwaszenko, and Marcin Michalak

Abstract—This work presents the UCGVision system designed for underground coal gasification process visualization, prediction, and monitoring. The possibility to visualize the ongoing reactions during the process is crucial for better insight into the process itself. Moreover, the system task is to give researchers and in the future process supervisor a tool to observe the current state of the process by a wide range of provided functionalities. This paper addresses problems regarding data presentation with utilization of computer graphics. Several issues concerning clear data presentation is discussed. The system performance is evaluated mostly on the modelled data, but it also enables the cooperation with a real time process observations.

Keywords—computer graphics, visualization, point cloud, process data, underground coal gasification

I. Introduction

The demand for the energy is growing in a rapid pace. Therefore, the search for innovative sources of energy is one of the most important challenges for a modern world. Although, the renewable energy sources are one of the most promising solutions to this problem, they still cannot fulfill all the requirements. Therefore, the utilization of fossil fuels will keep playing an important role in the near future [4][8]. On the other hand, the constant pressure to reduce the environmental impact of the energy sector makes usage of conventional energy sources more demanding. Hence, many research pay attention to the clean coal energy solutions. One of the suggested approaches is the controlling of the underground coal gasification process, which should be a comparable energy source to the conventional coal based plants, yet its environmental impact should be much smaller [2][3].

The underground coal gasification process is an alternative way of coal mining, which enables chemical conversion of coal. The idea assumes the gasification of the coal inside the seam and extracting only the resultant gases (syngas) which could be further processed [1]. Underground coal gasification makes utilization of not easily accessible coal deposits possible (e.g. thin coal seams). The idea to move the coal combustion underground in order to reduce the air pollution

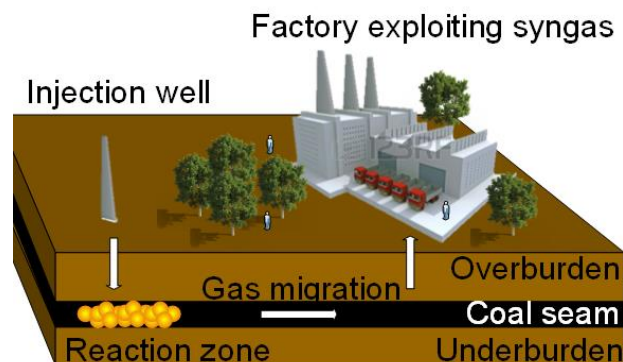

Figure 1. Example of the UCG process schema.

due to the coal burning was firstly suggested in 19th century [5], however the first trail experiments took place in the beginning of 20th century. Yet the first successful experiments were conducted in Soviet Union in 1934. Till now, few realization of this process in the world are known: in Soviet Union [5], Australia [8], and in the USA [5]. They proved that it is possible to achieve highly calorific gas, but also shown many troubles which must be solved before the process can be applied in any mine safely. Therefore, there are broad research [6][9] conducted in laboratory and semi-technical scale to solve encountered problems.

Fig. 1 presents one of the existing ideas of underground coal gasification process course. The coal seam, where the gasification process is taking place, is connected with the surface by two wells. There should be also provided a connection between these wells in the seam. Then the process is initiated by the injection well, and further on the gasification agent (oxygen, air, etc.) is inserted by this way. The other well is dedicated to collect the resultant gases (syngas) from the coal combustion process and might be a part of a factory, which uses the syngas for processing.

In result of the coal combustion in the seam, the cavity forms. Its shape, size, and place of development are very important from the UCG process management point of view, as it influences the process itself as well as the resultant gas quality. For instance, when the void reaches the surrounding rocks, which thermal conductivity is higher than the coal, the energy achieved during the coal combustion is dissipated, and the quality of syngas diminishes. Since the chemical reactions considered in this process have surface nature, it is better for gas quality, when the generated void is not too big, because then the amount of reaction releasing coal from the seam and changing it into unwanted carbon monoxide or carbon dioxide increases. Therefore, the possibility to model and visualize the cavity state became addressed in presented research.

Karolina Nurzyńska, Sebastian Iwaszenko
Central Mining Institute
Pl. Gwarkow 1, 40-166 Katowice, Poland
{knurzynska, siwaszenko}@gig.eu

Karolina Nurzyńska, Marcin Michalak
Institute of Informatics, Silesian University of Technology
ul. Akademicka, 44-100 Gliwice, Poland
{Karolina.Nurzynska, Marcin.Michalak}@polsl.pl

Recently, computer graphics finds a broad application in many domains, due to the high level of developed computer science solutions and relatively low costs of hardware. The aim of generated software is to simplify a cumbersome parts of labor and enable rapid access to information which manual acquisition is tedious and sometimes impossible to achieve without specialized equipment. The developed software aims to support employees in their duties, but also, as in this case, allows the analysis of the problem in order to research for novel technologies.

II. System Overview

The UCGVision software was developed in order to support research on the underground coal gasification process. The system enables visualization and analysis of model data of the process as well as data gathered during the experiments. The program was implemented in C#, .NET Framework 4.5 with utilization of XNA technology for data visualization and WPF for GUI creation. Additionally, all processed data is stored in MS SQL Server 2008 database.

Since the system is supposed to work with two different sources of data (generated by a mathematical model and recorded during experiments) it was decided that in the first step a unification of the data should be available. This approach enables similar presentation the data from each source and removes the labor of preparing different software to interpret different data. In order to meet this demand the UCGVision software was created from modules which process data on different level of abstraction. Fig. 2 presents the idea of information flow through the system. There are three main modules: data acquisition module, data preprocessing module and visualization module.

The data acquisition module is responsible for transforming the input data into an assumed structure of data necessary for presentation. The aim of this module is to read the input files and store the data in the database tables. In some cases the data normalization takes place, however on this level of system work the data stays in the raw format.

The data preprocessing module converts the input data in such a way to prepare a presentation according to parameters

specified by the user. This module reads the input data from the database (read data part) and stores results of its work also in database tables (data for visualization part). The data describing the proces (especially in the case of modelled data) may contain information about change of many parameters (e.g. amount of oxygen, carbon, carbon monoxide, carbon dioxide, temperature, pressure, velocity, etc.) in each point of measurement. Presenting all information not only is impossible in clear way but also make it difficult to understand the process. Therefore, the user may choose up to three parameters for one presentation. Additionally, it is possible to define which part of the observed proces should be presented and finally the mode of visualization should be decided. The system implements data presentation as a point of clouds or as an isosurface. The functionality will be discussed later in this paper.

The visualization module aims in data presentation. Here, the data for presentation prepared in previous module are retrieved from database and visualized on the user screen using 3D graphics. The user interactive presentation is provided to support easy manipulation of visualization.

III. Functionality

In order to enable the system to work with experimental and modelled data. Generated models correspond to the *ex situ* experiment described in [9]. The gasification process, simulating underground coal gasification, took place in purposely built gasification reactor, of dimensions 3m x 1.5m x 1.5m (LxWxH). The block of coal (1.5 x 0.8 x 0.8m) was firstly extracted from the mine and placed in a reactor chamber. On the bottom side in the middle, the gasification channel was drilled along the longest side, its cross-section was 0.1m x 0.1m. The void in the reactor was filled with sand to diminish the heat transfer. Fig. 3 presents the schema of the reactor.

A. Visualization

Data gathered for the presentation bases mostly on the mathematical model, which supplies many parameters. They

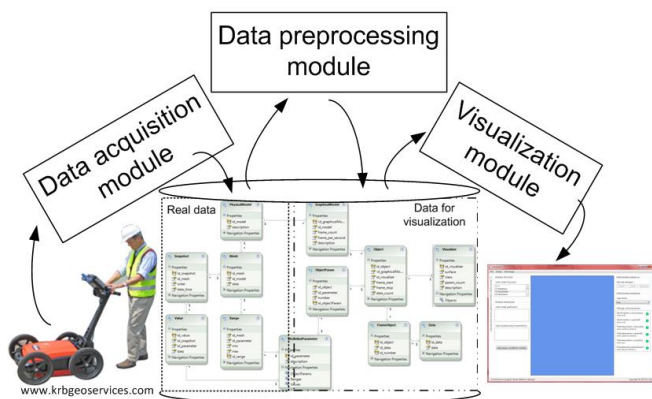

Figure2 Information flow in UCGVision software.

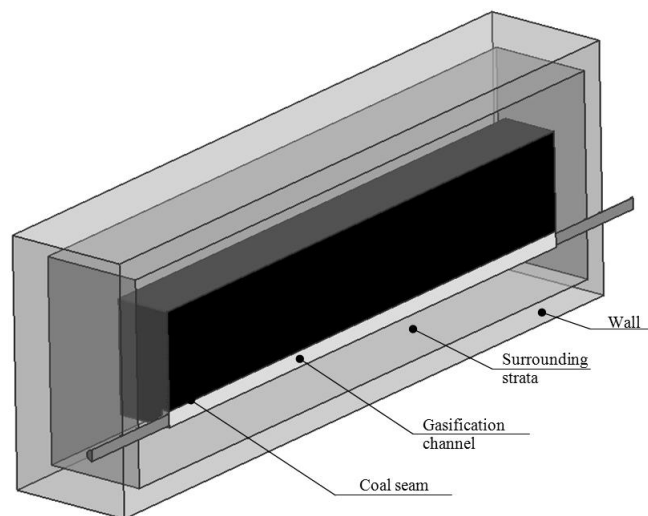

Figure 3. Cross-section through the reactor.

are estimated in a dense three-dimensional point cloud, which could be visualized in a raw format or transformed into a point cloud with selected points or as an iso-surface for a given parameter.

In the case of point cloud visualization it is assumed that up to three different parameters could be presented (one depicted with an object size, other with an object colour and the last with a rotation speed). The surface, in contrast, assumes presentation only of one parameter due to the importance of the shape, which corresponds to the cavity area, and therefore is very important for the process observation.

1) Point Selection

Generating visualization of the unorganized point cloud describing the values of chosen parameter in whole seam makes the information illegible due to the big amount of data. Therefore, it was decided that only the crucial data, which describe the cavity, should be presented.

A novel algorithm [4] was designed to choose the part of the point cloud which represent the interesting part. It was noticed, that the values in the corners of the observation region are in opposition to the values which convey the interesting information. Hence, considering the values distribution and using the proper quantile it is possible to filter out only those values, which are of interest (which describe the cavity region).

Additionally, this algorithm was improved to support work with multimodal data, when more parameters are considered. In this case, depending on the user choice, it is possible to generate the filtering rules, which enable logical AND or logical OR between the parameter values. This gives an

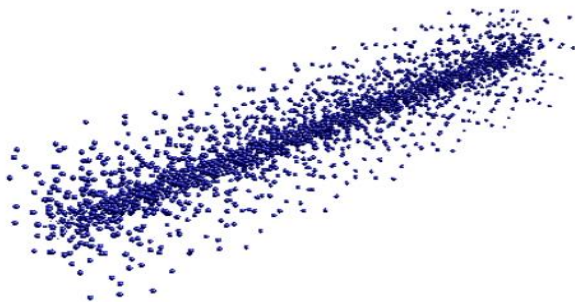

Figure 4 Visualization of point cloud data depicting the state of CO2 in the beginning of the UCG process.

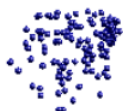

Figure 5 Visualization of points selected with the suggested approach in the beginning of the UCG process.

interesting tool for observation how the changes in different parameters composition influence the process.

Fig. 4 and Fig. 5 present examples of point cloud presentation for one parameter. The whole set of points depicting the ignition state is presented on Fig. 4. There one can easily notice the gasification channel, however small differences in parameter values make them impossible for observation. Therefore, applying the significance point algorithm finds its application here, as presented on Fig. 5.

2) Surface Reconstruction

As it was mentioned the cavity shape is also very important information for UCG process research. Therefore, additionally a surface reconstruction techniques were applied to show the void inside the seam. It was important not only to assure the reconstruction of the surface in each measuring point, but also a smooth transition between consecutive frames. Hence, the chosen approach in the first step creates a mesh which encloses inside the whole point cloud. Next, in iterative manner, the mesh vertices move in the direction of valid points in the point cloud. During the movement, additional algorithms support good mesh quality, by removing too small triangles, and splitting the big ones. Fig. 6 and Fig. 7 depict the surfaces generated for similar point clouds as in Fig. 4 and Fig. 5, respectively.



Figure 6 Visualization of surface enclosing while point cloud gathered similarly as on Fig. 4.



Figure 7 Visualization of surface enclosing selected points in the same manner as those from Fig. 5.

B. Data Presentation

In order to facilitate the data presentation and to give the user full control over the observed data five cameras are implemented in the system. Four of them are static cameras which are placed in the top corners of the bounding box calculated around the data looking in the direction of data center. The fifth one is a free camera which enables the user to zoom in and zoom out the object, rotate around the object, move up and down, right and left. Figure 8 gives the overview of the zooming option.

Additionally, the user is supported with a legend, which informs about the presented parameters, their ranges, ways of visualization. The camera movement is reflected by the rose of wind in the bottom right corner.

The most interesting phenomena concerning the UCG process take place in time. Therefore, the data is presented in the form of a movie, which consecutive frames concern the data recorded in the next snapshots of the model calculation or intervals selected for data collection during experiments. The number of frames (speed of data presentation) is defined by the user during the graphical model calculation. Additionally, during the preparation step the user may define, which parameters should be presented (up to three).

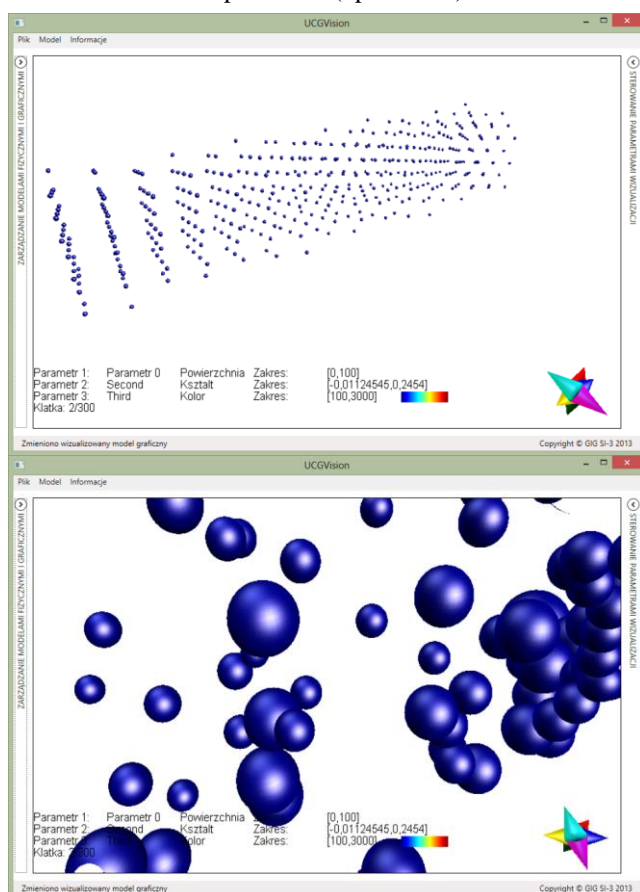

Figure 8 Visualization of UCG data - the model overall view (on the top) and zoomed in region (on the bottom).

IV. Results

The presented functionality of the UCGVision system gives a wide overview on the UCG process course. It enables not only the observation of change of chosen parameters, but enables easy choice of the crucial data in each time of the process. Various presentation modes support the user with broad range of data analysis tools. User friendly interface make the visualization preparation simple. Moreover, because each prepared visualization is stored in the database, it can be reviewed many times and compared with other measurements easily.

V. Conclusion

This paper presents the UCGVision software designed in order to support the research concerning the underground coal gasification process. The system main goal was to enable various data presentation in order to facilitate understanding of the reactions taking place during the process. Several of data presentation and manipulation functionalities were presented and are satisfactory for the current users.

In future, there are plans to expand the system of cross-section plane, which enable showing the data distribution over a chosen plane. Moreover, some improvements concerning the visualization effectiveness will take place.

Acknowledgment

The research presented in this work is funded by the National Research and Development Centre in project titled: "Visualization of the development of cavities in the process of underground gasification of coal". Agreement number: LIDER/09/30/L-2/10/NCBiR/2011.

References

- [1] D.A. Bell, B.F. Towler, M. Fan: Goal Gasification and its Applications, Elsevier, 2011.
- [2] A. W. Bhutto, A. A. Bazmi, and G. Zahedi, "Underground coal gasification: From fundamentals to applications.", Progress in Energy and Combustion Science 39, pp. 189 – 214, 2013
- [3] B. Bialecka, „Podziemne zgazowanie węgla. Podstawy procesu decyzyjnego”, Główny Instytut Górnictwa, Katowice 2008.
- [4] A. G. Collet, "Matching gasification technologies to coal properties.", International Journal of Coal Geology 65, pp. 191–212, 2006.
- [5] A. Y. Klimenko: Early ideas in underground coal gasification and their evolution. Energies, vol. 2, pp. 456-476. Doi:10.3390/en20200456, 2009.
- [6] K. Kostúr, J. Kačur: The monitoring and control of underground coal gasification in laboratory conditions. Acta Montanistica Slovaca, vol. 13(1), pp. 111-117, (2008).
- [7] K. Nurzyńska, M. Michalak, S. Iwaszenko: „Visualization of UCG Process Data”, 2014.
- [8] E. Shafirovich, A. Varma: "Underground Coal Gasification: A Brief Review of Current Status". Ind. Eng. Chem. Res.2009,48,7865–7875.
- [9] K. Stańczyk, N. Howaniec, A. Smoliński, J. Świądrowski, K. Kapusta, M. Wiatowski, J. Grabowski, J. Rogut: Gasification of lignite and hard coal with air and oxygen enriched air in a pilot scale ex situ reactor for underground gasification. Fuel, vol. 90 (5), pp. 1953-1962, (2011).

About Author (s):



Karolina Nurzyńska received her M.Sc. Eng. and Ph.D. degree in the field of computer science from the Silesian University of Technology, Poland in 2005 and 2009, respectively.

She was the postdoctoral fellow in the School of Electrical and Computer Engineering, Kanazawa University, Japan in years 2009 - 2011. Since then she is working at Central Mining Institute, Poland, realizing a grant titled “Visualization of the development of cavities in

the process of underground gasification of coal” funded by the Polish National Research and Development Centre. She became an Assistant Professor at CMI in 2012. Since 2013 she also holds the position of Assistant Professor at the Institute of Informatics, Faculty of Automata Control, Electronics, and Computer Science, the Silesian University of Technology, Poland. Her research interests include image processing and understanding as well as 3D surface reconstruction and visualization techniques.



Sebastian Iwaszenko received his M.Sc. Eng. degree in the field of computer science from the Silesian University of Technology, Poland in 1995 and Ph. D. degree in the field of environmental engineering from the Central Mining Institute, Poland in 2008.

Since 2005 he has been working at Central Mining Institute, Poland, taking part in several research projects. In 2011 he joined a team realizing a grant titled “Visualization of the development of cavities in the process of underground gasification of coal” funded by the Polish National Research and Development Centre. His research interests include software engineering, image processing, 3D visualization techniques and application of computer science in mining and environmental engineering.



Marcin Michalak received his M.Sc. Eng. and Ph.D. degree in the field of computer science from the Silesian University of Technology, Poland in 2005 and 2009, respectively.

He was a postdoctoral fellow in the School of Electrical and Computer Engineering, Kanazawa University, Japan in years 2009 - 2011. Since then he is working at Central Mining Institute, Poland, realizing a grant titled “Visualization of the development of cavities in the process of underground gasification of coal” funded by the Polish National Research and Development Centre. His research interests include software engineering, image processing, 3D visualization techniques and application of computer science in mining and environmental engineering.

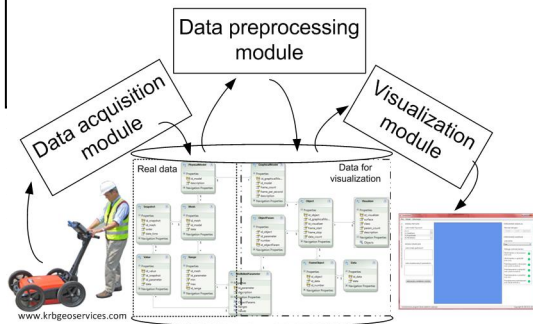

Central European
 International