

# A simple way to model urban attenuation using Friis equation

Fabiola Martínez-Zúñiga, Jorge Sosa-Pedroza

**Abstract.** Friis equation describes relationship between power leaving transmitting antenna and power delivered by receiving antenna; we present in this paper a modification of the Friis Free Space Attenuation equation to model propagation in urban scenarios. We adjust it changing the exponent value of 2 and adding an arbitrary attenuation factor to fit regression curves obtained from measurements made in Mexico City in the frequency of 3.3 GHz, after find scenarios with similar characteristics in different places of Mexico City.

**Keywords:** Modification of Free Space Attenuation, Measurement of urban attenuation, WiMAX.

## I. INTRODUCTION

Wireless communication systems are evolving rapidly, prediction of urban attenuation becomes an important issue to work with. Many models had been developed to predict attenuation for different environments and frequencies adapted for specific areas around the world. Since the model of Okumura and Hata to the one of Erceg [1,2,3], many others have been developed to cover specific scenarios for each city, trying to describe propagation attenuation, considering differences between building heights and kind of constructions, as well as street widths. But prediction is adapted for each city or a new model is created for a specific environment. Nevertheless most communications planners use the model which best adapt to their needs of frequency and building construction.

After a measurement campaign in Mexico City streets we compare them with different models looking for the one which best adapt our attenuation measurements, finding big differences in both cases, a logic result considering the especial construction environment of our city. As many Latin American cities, Mexico City has a mobile communication environment, different to those from Europe and US, where models were defined. This paper, analyze our own scenarios adjusting attenuation Friis equation [4], trying to find the best relationship between measurements and modifications.

---

Fabiola Martínez-Zúñiga  
ESIME Zacatenco, Instituto Politécnico Nacional  
México

Jorge Sosa-Pedroza  
ESIME Zacatenco, Instituto Politécnico Nacional  
México

## II. METHODOLOGY

Although we have measured attenuation in Mexico City environment, for frequencies ranging from 400 MHz to 5.5 GHz, we present in this paper the methodology applied to a WiMAX System in 3.3 GHz, which is intended to use, as a metropolitan area service system with one or more base stations, within a range of 50 km, for data distribution in large wireless broadband geographical areas. Figure 1 shows the operational principle of WiMAX [5,6].

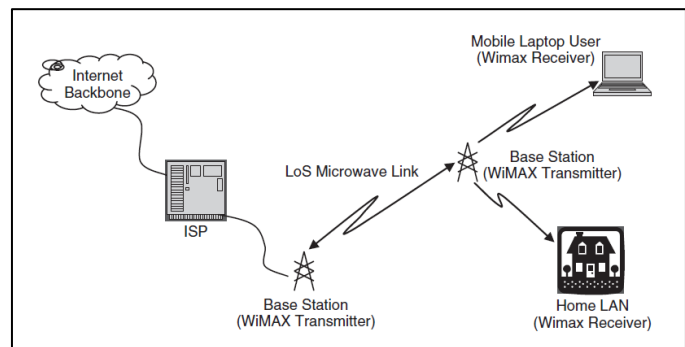

Figure 1. Operational principle of WiMAX

Methodology we applied follows next steps:

1. Identification of scenarios, over designated areas.
2. Measurement campaign.
3. Construction of regression curves using measurement data.
4. Validation of similar scenarios comparing regression curves of different measurement areas.
5. Construction of attenuation curves using attenuation Friis equation, modifying power exponent.
6. Comparison of slopes for both, regression and Friis equation curves.
7. Choose of slope, which better fits regression curves.
8. Adjust differences with an arbitrary attenuation constant, between selected slope and regression curves.

## III. FREE SPACE ATTENUATION MODEL

As is known, free space power loss of Friis Equation ( $PL_{FS}$ ), which supposes a free obstacle region between transmitter and receiver, is given by [4]:

$$PL_{FS} = \left(\frac{4\pi df}{c}\right)^2 \quad (1)$$

where

- d: distance between transmitter and receiver
- f: operating frequency
- c: speed of light

We propose to modify  $PL_{FS}$  as:

$$PL_{FS} = \left(\frac{4\pi df}{c}\right)^X \pm Y \quad (2)$$

As seen in (2), we change equation exponent using (X) to modify slope and adding an arbitrary attenuation factor (Y) for final adjustment. We define (X) and (Y) matching slope and attenuation, as best as possible, with regression curves.

#### IV. AREA DEFINITION, VALIDATION AND IDENTIFICATION OF SCENARIOS, AND MEASUREMENT CAMPAIGN.

Measurements were performed using base stations located in the Humanidades II building in the National University (UNAM) at the south of Mexico City, at Dirección de Cómputo y Comunicaciones (DCyC) in the Instituto Politécnico Nacional (IPN) at the north of the city and in the Instituto de Ciencia y Tecnología (ICYT) in downtown. We define four scenarios, using Erceg's definition [5] and identified a different one, exclusive of our city.

Table I shows communication system characteristics with two different antenna heights, 70 m for UNAM measurements and 29 m for other two places.

TABLE I COMMUNICATION SYSTEM FEATURES

|                            |             |
|----------------------------|-------------|
| Operating frequency        | 3,4785 GHz  |
| Bandwidth                  | 3,5 MHz     |
| Transmitter power          | -7 dBW      |
| Transmitter antenna height | 29 and 70 m |
| Receiver antenna height    | 2 m         |
| Transmitter antenna gain   | 14,8 dBi    |
| Receiver antenna gain      | 3,6 dBi     |

Measurements were made using an analyzer Anritsu Master Spectrum MS2721B, which includes a GPS antenna for referenced positioning. Antennas were mounted on top of a vehicle, equipment saved received power level and geographic location (latitude and longitude coordinates) for each measurement point, as shown in Figure 2.

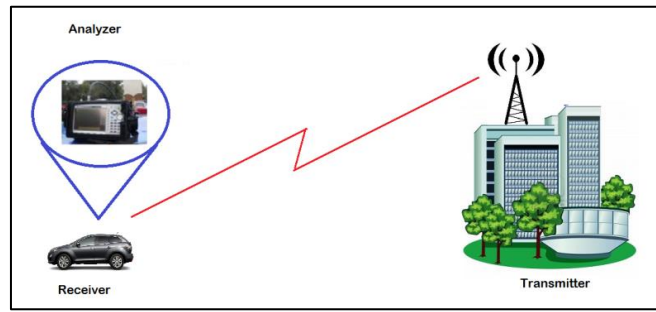

Fig. 2. Measurement scheme

Measurements were taken every 20 seconds, after time analyzer updates GPS position. A data base with extension wxme was constructed, extracting measurements from spectrum analyzer, becoming in computer txt files containing latitude, longitude, distance and input power.

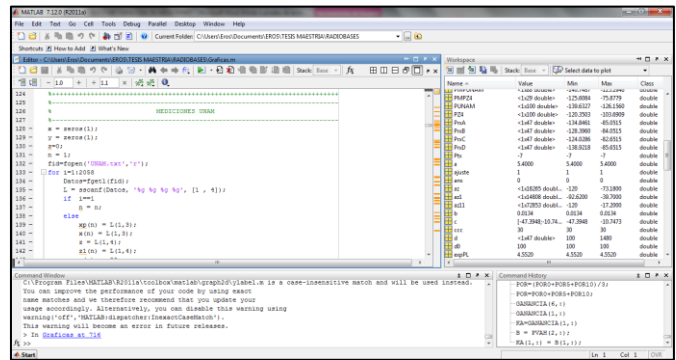

Fig. 3. Information processing using Matlab.

We develop a Matlab program to construct tables, as that shown in Figure 3, extracting only the necessary information from each file; table shows field power, position and distance where measurements were taken. Database is used to construct linear regression curves, to compare with adjustments of  $PL_{FS}$ .

We identified 5 scenarios in the two selected areas, described as follow:

#### A. Scenario 1: low buildings with low tree density

This scenario considers an area with a low tree density, and low height buildings, as shown in Figure 4.



Fig. 4. Scenario 1

### *B. Scenario 2: low buildings with medium tree density*

The scenario considers an area with medium tree density and low height buildings, as the one shown in Figure 5.



Fig. 5. Scenario 2

### *c. Scenario 3: area with a high tree density*

Figure 6 shows a scenario with a high tree density.



Fig. 6. Scenario 3

### *D. Scenario 4: tall buildings with medium tree density*

The scenario considers an area with medium tree density and high height buildings.

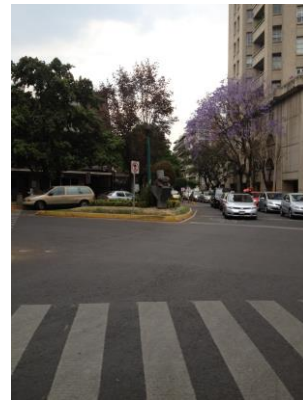

Figure 7. Scenario 4

### *E. Scenario 5: Colonial city*

Scenario 5, shown in figure 8, is a unique environment of Mexico City (and many Latin American cities), it is located at historic downtown; it has some very unique construction features such as large width walls, tall buildings, and narrow streets as the one back in the center of photograph.



Fig 8. Scenario 5

Figures 9 and 10 show UNAM and IPN zones where measurements were made for scenarios 1 through 4, each one bounded for different colors. The blue frame define scenario 1, while scenario 2 is red, green for scenario 3 and orange for scenario 4. Each scenario was visually distinguished from both base stations photos.

Figure 11 shows the unique scenario 5. Although is not clear from the photo the differences with other scenarios, is possible to distinguish them from Figure 8, specially the narrow background street between the colonial buildings.

After each bounded polygon was defined by its geographical position, measurement data base was used to construct regression curves for attenuation behavior. Curves were used, to validate scenarios 1-4 comparing them from measurement for both areas, UNAM and IPN; slope and attenuation similarities gave us an idea if selection was correct. Scenario 5, is a unique one, and do not have any comparison at all.



Fig. 7. Radio base located in the UNAM



Fig. 10. Base station in IPN



Fig. 11. Base Station of scenario 5.

## V. COMPARISON OF REGRESSION CURVES WITH MODIFIED FRIIS EQUATION.

Next step was to adjust  $PL_{FS}$  trying to match slope and attenuation as best as possible with regression curves of base stations. Adjustment is made changing the exponent value ( $X$ ) for the slope and ( $Y$ ) for losses magnitude, in equation 2.

Although we tried different numbers for  $X$  we found that regression curves had similar slopes for  $X=2$  and  $X=3$  as figure 12 shows. With these two values, final adjustment was obtained adding or subtracting an arbitrary attenuation  $Y$ .

We can see in Figure 12, that regression curves can match their slopes in either one of modified  $PL_{FS}$ , scenario 1 (blue) and scenario 4 (black) match their slopes with curve for  $X=3$  while other 3 have a better matching with  $X=2$ , the only difference between regression curves and  $PL_{FS}$  is attenuation's magnitude, then we adjust parameter  $Y$  to fit both curves.

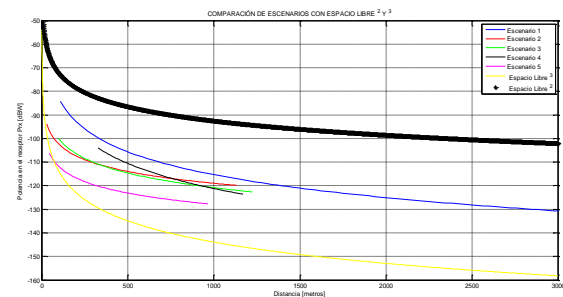

Figure 12. Slope comparison

Following curves show final adjustment of  $PL_{FS}$ , fitting regression curves with modeled free space attenuation. We notice two facts in those graphs. One is that difference, between measurements for the two areas of interest (IPN and UNAM), do not exceed more than 3 dB, meaning that we have a good scenarios selection. On the other and, after adjustment  $PL_{FS}$  in each scenario, difference does not exceed more than 2

dB in all cases, except in scenario 4, with a difference around 4 dB. Final results are presented in following paragraphs.

Figure 13 shows adjustments for scenario 1; we found that  $X=3$  and  $Y=29$  then:

$$P_{E1} = EIRP + Gr - \left(\frac{4\pi d f}{c}\right)^3 + 29 \quad (3)$$

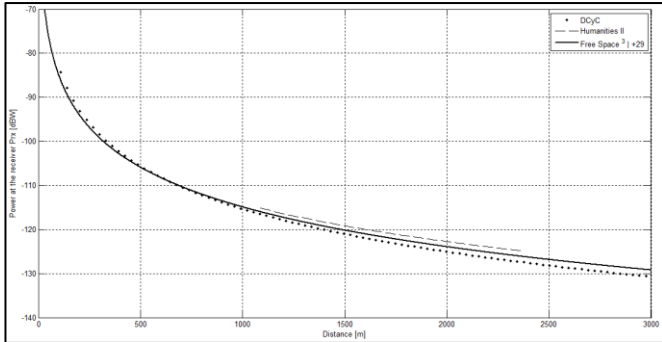

Fig. 13. Adjustment of  $PL_{FS}$  for scenario 1.

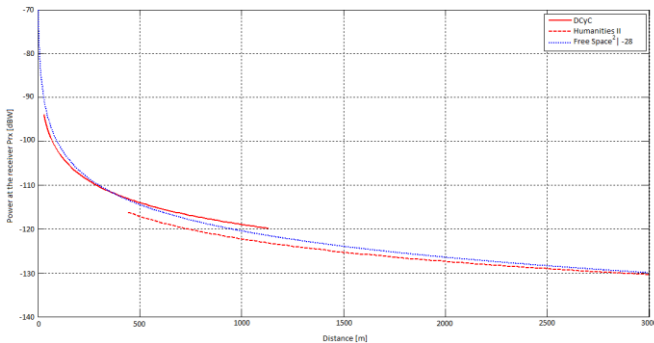

Fig. 14. Comparison of base stations and adjust of  $PL_{FS}$  for scenario 2.

Figure 14 shows adjustment of  $PL_{FS}$  power for scenario 2 leading to depicts measurements comparison of same base stations, leading to scenario 2 validation, considering the slopes similitud with no higher than 3 dB difference. Figure 14 also:

$$P_{E2} = EIRP + Gr - \left(\frac{4\pi d f}{c}\right)^2 - 28 \quad (4)$$

We select a  $PL_{FS}$  adjust curve between both base station regression curves, giving a difference between  $PL_{FS}$  and measurement no higher than 1.5 dB. As seen the exponent value do not change ( $X=2$ ); magnitude of attenuation factor is selected as  $Y = -28$  for scenario 2.

In the same way we compare curves for scenario 3, as shown in Figure 15; again the slope of regression curves are similar, with a difference of power no greater than 5 dB, which validates the environment. After adjustment, we select a curve for  $PL_{FS}$  between both regression curves; power equation is expressed as:

$$P_{E3} = EIRP + Gr - \left(\frac{4\pi d f}{c}\right)^2 - 31 \quad (5)$$

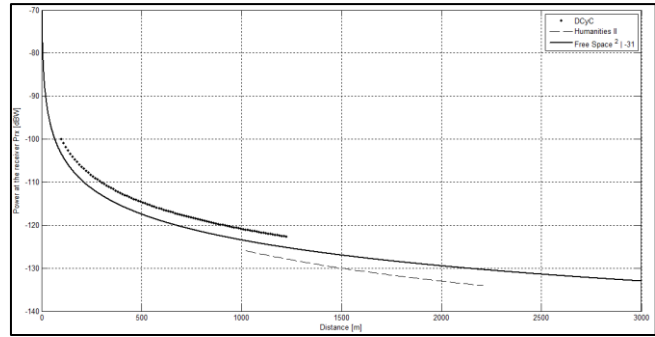

Fig. 15. Base station comparison and adjust of  $PL_{FS}$  for scenario 3.

Following same procedure, we compare results for scenario 4. Regression curves are shown in Figure 16. As seen slopes of both curves are different, although no more than 1.5 dB between 100 m and 1200 m. Differences are greater for larger distances, meaning scenario 4 needs further analysis.

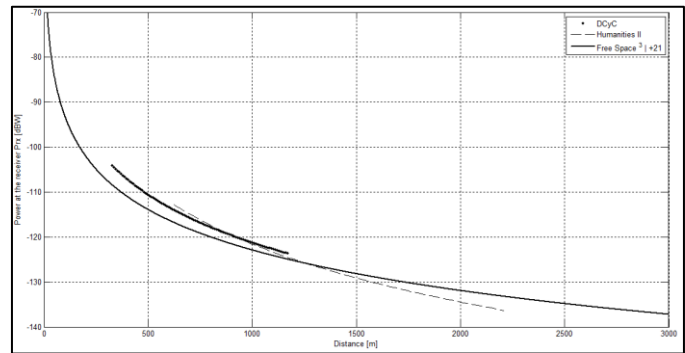

Figure 16. Base stations comparison and  $PL_{FS}$  adjust for scenario 4.

Although two power slopes are different, a good  $PL_{FS}$  adjustment was found as:

$$P_{E4} = EIRP + Gr - \left(\frac{4\pi d f}{c}\right)^3 + 21 \quad (6)$$

As scenario 5 is unique, is not possible to compare with any other curve. Figure 17 shows  $PL_{FS}$  adjustment, fitting measurement regression curve. As can be seen from Figure 17, there is a sharp slope fall, similar to that of scenario 3, meaning a zone of high attenuation, due the tall buildings with very dense walls and narrow streets. Adjustment for  $PL_{FS}$  is:

$$P_{E5} = EIRP + Gr - \left(\frac{4\pi d f}{c}\right)^2 - 36 \quad (7)$$

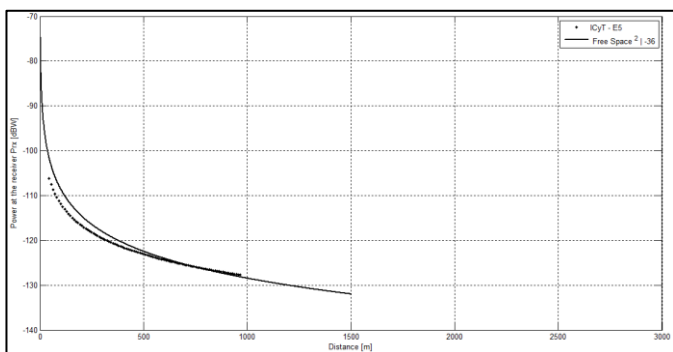

Fig. 17. Adjust of  $PL_{FS}$  for scenario 5.

Table II shows a summary of adjustments for all scenarios.

TABLE II SUMMARY OF  $PL_{FS}$  ADJUSTMENT

|            | Exponent | Loss (dB) |
|------------|----------|-----------|
| Scenario 1 | 3        | + 29      |
| Scenario 2 | 2        | - 28      |
| Scenario 3 | 2        | - 31      |
| Scenario 4 | 3        | + 21      |
| Scenario 5 | 2        | - 36      |

As seen in Table II, scenarios 1 and 4 have similar slopes, with an exponent of 3. Furthermore the loss adjustment for  $PL_{FS}$  is increased with 29 and 21 dB respectively.

For scenarios 2 and 3, the slope has the same exponent of 2, and loss requires an adjustment of -28 and -31 dB respectively, only a 3 dB difference.

## VI. CONCLUSION

After identification of some common scenarios in Mexico City as: low buildings-low tree density; low buildings-medium tree density; high tree density zone; tall buildings-medium tree density; Colonial City, we compare measurements over city streets with  $PL_{FS}$ , to find a relationship between them.

Considering similarities for two base stations, we validate scenarios selection, at least for 4 of them, leaving scenario 5 as unique.

Comparing measurements for each scenario with adjusts of exponent and amplitude of  $PL_{FS}$  losses, we conclude that model can predict path loss for WiMAX or similar communication standard. Further more we find that, differences between measurement and prediction is as much of 5 dB. We think that those 5 dB differences is a good margin, to predict propagation of mobile communication systems over an environment as Mexico City. Probably we have to define an accepted margin, but accordingly with our experience a 10 dB could be a good number.

## REFERENCES

- [1] Masaharu Hata "Empirical Formula for Propagation Loss in Land Mobile Radio Services" IEEE Transactions on Vehicular Technology, Vol. VT-29, No. 3, August 1980.
- [2] Y. Okumura et al. "Field strength and variability in VHF and UHF land-mobile radio service" Rev. Elec. Commun. Lab., vol. 16, 1968.
- [3] Vinko Erceg et al. "An Empirical Based Path Loss Model for Wireless Channels in Suburban Environments", IEEE, Journal on Selected Areas in Communications, Vol. 17, No. 7 July 1999.
- [4] John D. Kraus, Keith R. Carver, "Electromagnetics", 1981, 9<sup>th</sup> edition McGraw Hill pp. 698.
- [5] D. Pareek, "WiMAX Taking Wireless to the MAX", 1<sup>st</sup> ed, Ed. Taylor & Francis Group, 2006.
- [6] S. Y. Tang, "WiMAX Security and Quality of Service", 1<sup>st</sup> ed, Ed. Wiley, 2010.