

# HARMONIC DISTORTION CONTROL TECHNIQUE FOR UNINTERRUPTIBLE POWER SUPPLIES WITH DC VOLTAGE BOOST TECHNIQUE

## UNINTERRUPTIBLE POWER SUPPLY

PEEYUSH AGARWAL , ARVIND S.M , SANGYA THAKUR , SRM UNIVERSITY,  
CHENNAI, INDIA

**Abstract—** This paper presents a new control strategy for UPS inverter, which is based on the addition of the DC voltage boost compensation for keeping the fundamental output voltage at the preset value and suppressing the generation of low-order harmonics caused by nonlinear load. Thus, the proposed strategy is viewed as a refinement term added to the outer voltage control loop. The new strategy is quite simple and requires only the measurement of the output voltage to compute the THD.

**Keywords-** Uninterruptible Power Supply, Harmonic Distortion, Simulation

### I. UNINTERRUPTIBLE POWER SUPPLY

An uninterruptible power supply, also uninterruptible power source, UPS or battery/flywheel backup, is an electrical apparatus that provides emergency power to a load when the input power source, typically mains power, fails. A UPS differs from an auxiliary or emergency power system or standby generator in that it will provide near-instantaneous protection from input power interruptions, by supplying energy stored in batteries or a flywheel. The on-battery runtime of most uninterruptible power sources is relatively short (only a few minutes) but sufficient to start a standby power source or properly shut down the protected equipment.

### II. COMMON POWER PROBLEMS

The primary role of any UPS is to provide short-term power when the input power source fails. However, most UPS units are also capable in varying degrees of correcting common utility power problems:

- Voltage spike or sustained Overvoltage
- Momentary or sustained reduction in input voltage.
- Noise, defined as a high frequency transient or oscillation, usually injected into the line by nearby equipment.
- Instability of the mains frequency.

- Harmonic distortion: defined as a departure from the ideal sinusoidal waveform expected on the line.
- UPS units are divided into categories based on which of the above problems they address, and some manufacturers categorize their products in accordance with the number of power-related problems they address.

### III. PROTECTIVE DEVICES OTHER THAN UPS

- surge protective devices – spd's
- protects against spikes of limited energy
- metal oxide varistors – mov
- diodes
- gas tubes
- lcr filters
- hybrids
- line filters
- filters out harmonics, transients and noise
- isolation transformer eliminates dc offset and noise
- voltage regulating line conditioner
- automatically adjusts for under and over voltages
- constant voltage transformer - cvt
- motorized variac.

### IV. TECHNOLOGIES

The general categories of modern UPS systems are on-line, line-interactive or standby. An on-line UPS uses a "double conversion" method of accepting AC input, rectifying to DC for passing through the rechargeable battery (or battery strings), then inverting back to 120 V/230 V AC for powering the protected equipment. A line-interactive UPS maintains the inverter in line and redirects the battery's DC current path from the normal charging mode to supplying current when power is lost. In a standby ("off-line") system the load is powered directly by the input power and the backup power circuitry is only invoked when the utility power fails. Most UPS below 1 kVA are of the line-interactive or standby variety which is usually less expensive.

#### A. Offline/Standby

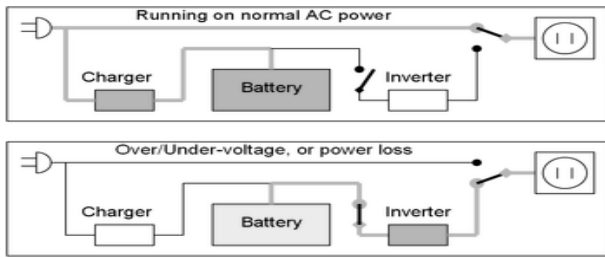

Offline / standby UPS. Typical protection time: 0–20 minutes.  
 Capacity expansion: Usually not available

The offline/standby UPS (SPS) offers only the most basic features, providing surge protection and battery backup. The protected equipment is normally connected directly to incoming utility power. When the incoming voltage falls below or rises above a predetermined level the SPS turns on its internal DC-AC inverter circuitry, which is powered from an internal storage battery. The SPS then mechanically switches the connected equipment on to its DC-AC inverter output. The switchover time can be as long as 25 milliseconds depending on the amount of time it takes the standby UPS to detect the lost utility voltage. The UPS will be designed to power certain equipment, such as a personal computer, without any objectionable dip or brownout to that device.

#### B. Line-Interface

Line-interactive UPS. Typical protection time: 5–30 minutes.  
 Capacity expansion: Several hours

The line-interactive UPS is special type of transformer that can add or subtract powered coils of wire, thereby increasing or decreasing the magnetic field and the output voltage of the transformer. This is also known as a Buck–boost transformer.

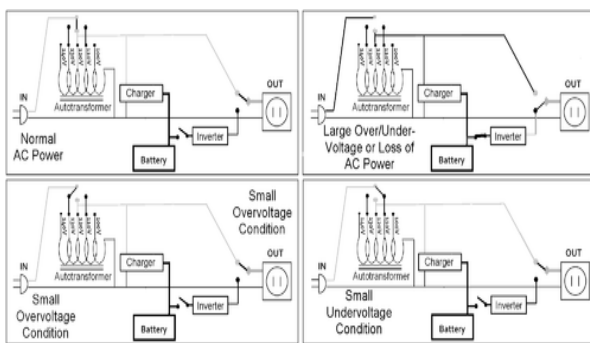

This type of UPS is able to tolerate continuous undervoltage brownouts and overvoltage surges without consuming the limited reserve battery power. It instead compensates by automatically selecting different power taps on the autotransformer. Depending on the design, changing the autotransformer tap can cause a very brief output power disruption, which may cause UPSs equipped with a power-loss alarm to "chirp" for a similar in operation to a standby UPS, but with the addition of a multi-tap variable-voltage autotransformer. This is a moment.

#### C. Online/Double-Conversion

The online UPS is ideal for environments where electrical isolation is necessary or for equipment that is very sensitive to power fluctuations.

The basic technology of the online UPS is the same as in a standby or line-interactive UPS. However it typically costs much more, due to it having a much greater current AC-to-DC battery-charger/rectifier, and with the rectifier and inverter designed to run continuously with improved cooling systems. It is called a double-conversion UPS due to the rectifier directly driving the inverter, even when powered from normal AC current.

#### D. Other designs

- Hybrid topology / double conversion on demand
- Ferro-resonant
- DC power
- Rotary

#### V. HARMONIC DISTORTION

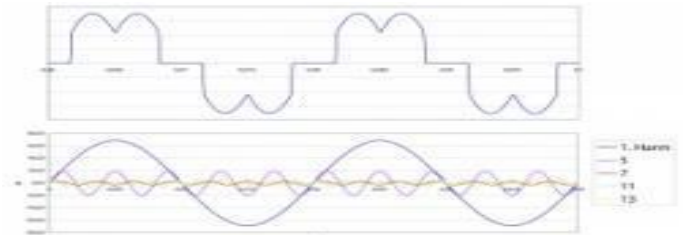

Irregular power supplies influence the performance and operation of electrical equipment, so motors, frequency converters and transformers must be more highly rated to maintain proper operation.

The mains voltage supplied by electricity utilities to homes, businesses and industry should be a uniform sinusoidal voltage with a constant amplitude and frequency.

This ideal situation is no longer found in any power grid. This is mainly because consumers take non-sinusoidal current from the grid or have a nonlinear characteristic, for example, strip lights, light dampers, energy-saving bulbs and frequency converters. Because of the constantly increasing use of non-linear loads, deviations become increasingly serious.

THD is defined as ratio of the power in the supply due to all the harmonics and the power of the fundamental supply.

$$THD = \frac{\sum_{n=2}^{\infty} P_n}{P_1}$$

In modern electrical systems, power electronics are used to control the circuits. These power electronics including almost

all of the domestic gadgets like computers etc require DC power supplies to operate. The utility supply is a 3-phase AC supply as shown here.

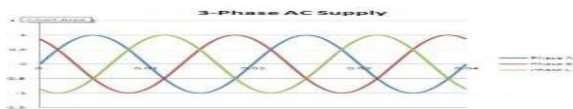

Fig: Phase Supply

The waveform shown here is a perfect sine wave at a frequency of 50Hz. For simplicity the amplitude is normalised to 1.

With the advent of modern electronics, appliances became non-linear in the way they drew current through the mains electricity supply. The variable frequency drives and UPS systems are a major source of harmonics being injected into the electrical system and without proper protection, these harmonics can affect other parts of the plant and even the grid. UPS systems convert the incoming AC to a DC signal to charge batteries in the event of a power outage – the DC component is a very high frequency signal and it interferes with the near perfect AC power supplies (most of the distortion in the modern power network is customer generated).

In order to achieve fast dynamic response and eliminate output voltage distortion under nonlinear loads, many improved control systems have been proposed such as sliding mode control, multi- loop, optimal state feedback, repetitive-based control, deadbeat control, and many others.

The disadvantage is that the maximum PWM voltage area of the pulse is limited by the computation and sampling time. This limitation results in relative large harmonic components occurring for nonlinear loads. In addition, all such control strategies are slightly complex to implement.

In this paper, a simple THD reduction technique with addition of DC voltage boost compensation is proposed. In this technique, a DC voltage boost signal which is proportional to the THD value of the inverter output voltage is injected into the conventional PFC outer voltage loop. Then, the switching instance can be determined that the PWM voltage areas of the inverter are proportional to the instantaneous THD value. The THD value is obtained at every sampling cycle from the feedback of inverter output voltage. The desired DC voltage boost signal is determined through THD reduction control loop. As a result, the proposed control scheme leads to improve the THD of the inverter output voltage while keeping an acceptable dynamic response.

## VI. CONTROL STRATEGY

In order to provide precise voltage control of inverter, any harmonic distortion must be properly compensated. However, conventional PFC control with constant DC voltage cannot

achieve good performance under nonlinear loads disturbance. By introducing the DC voltage boost technique in the conventional voltage control loop of PFC rectifier, the performance of the single-phase PWM inverter can be optimized so that the output voltage is controlled with low THD. The proposed DC voltage boost scheme with improved steady-state performance (An extra THD Reduction control loop) is then added at the input of the conventional PFC voltage-loop to yield satisfactory inverter performance. In this technique, instead of a fixed DC voltage, a boost DC voltage  $v_{boost}$  which is proportional to the THD value  $v_{THD\_FDBK}$  is injected at the input of the PFC rectifier. The output voltage  $v_o$  of the UPS inverter is sampled and calculated to a detected THD value  $v_{THD\_FDBK}$  that is required for THD reduction control loop. The error signal between the THD threshold value  $V_{thd}$  and detected THD value  $v_{THD\_FDBK}$  is then passed to a PI controller and the desirable boost signal  $v_{boost}$  is thus generated. Due to the negative feedback in the THD reduction loop, the boost signal  $v_{boost}$  changes in such a manner that the inverter output voltage is modulated so that the minimum THD is obtained. Finally, DC voltage boost signal is combined with voltage command  $v_{DC}$  of conventional PFC control to form the new command signal  $v_{Dc}$ . From the description above, one can derive the following key equations for resistive load and nonlinear load, respectively:

FIG: Simulated results of rectifier load operation without compensation. (a) THD of output voltage (b) DC voltage  $v_{DC}$  waveform (c) output voltage  $v_o$  waveform (d) load current  $i_o$  waveform.

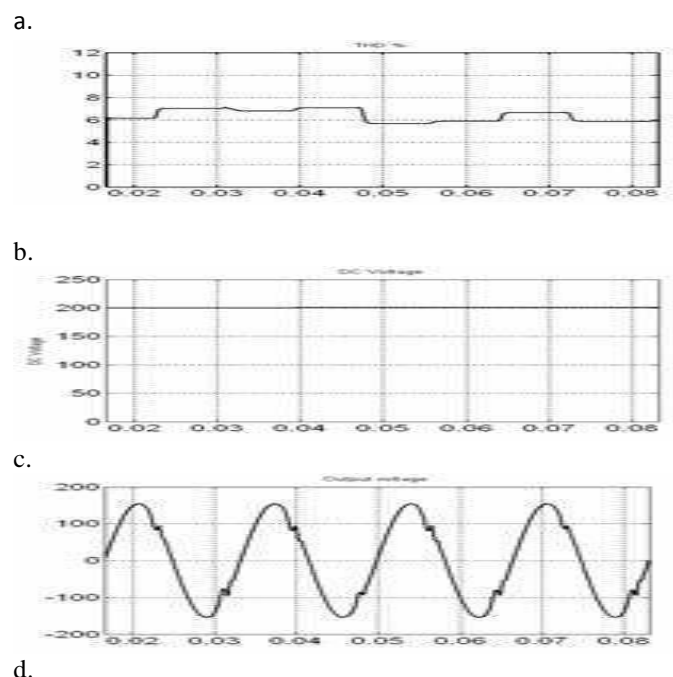

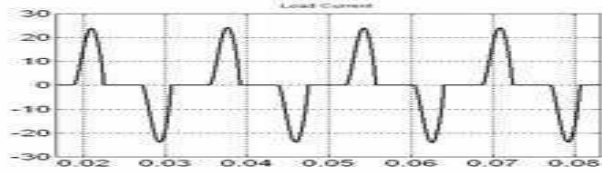
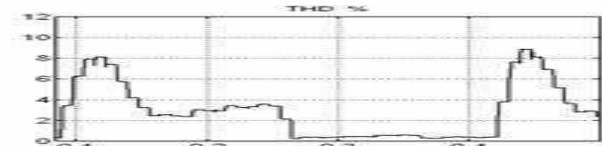
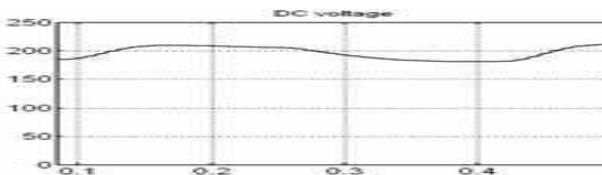

FIG : Simulated results with compensation when load changes from rectifier load to resistive load. (a) THD of output voltage (b) DC voltage vDC waveform (c) output voltage vo waveform (d) load current io waveform. (e) Inverter output voltage vPWM waveform.

a.



b.



c.

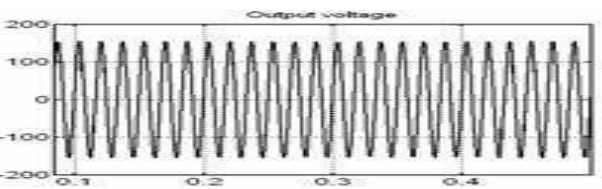

d.

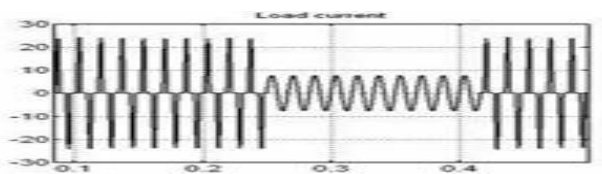

e.

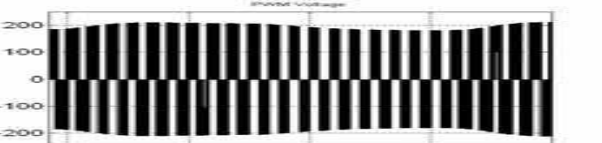

## VII. CONCLUSION

A simple and effective control strategy for the THD reduction of inverter output voltage is proposed. To improve the performance of the UPS inverter, a DC voltage boost technique is added to significantly suppress the output voltage distortion caused by nonlinear load and thus nearly sinusoidal output voltage waveform is obtained. Transient response to load step changes is presented to indicate that good output voltage regulation with low THD are obtained simultaneously. Besides, the steady state performance is rather

insensitive to DC voltage fluctuation and load variations. The present work is still on-going. The author is encouraged to ask for additional information on experimental results.

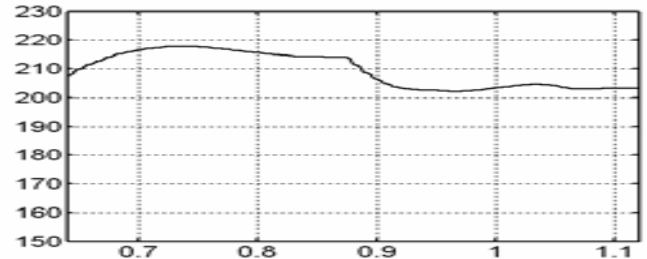

DC voltage vDC

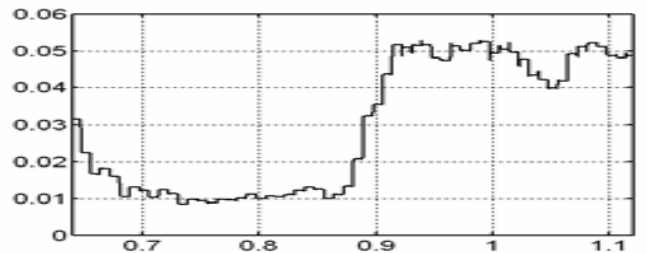

THD value vTHD FDBK

## ACKNOWLEDGMENTS

We want to thank Ms. K. Sharmila Devi, E.I.E.DEPARTMENT, SRM UNIVERSITY for opening the doors to this platform.

## REFERENCES

- [1] Juei Lung Shyu Department of Electrical Engineering, Kao Yuan University  
 "harmonic distortion control technique for uninterruptible power supplies with dc voltage boost technique"
- [2]. John Liguori consulting engineer msee, presentation on 'uninterruptible power supply'
- [3]. Henry Shu-Hung Chung" A Novel Maximum Power Point Tracking Technique for Solar Panels Using a SEPIC or Cuk Converter,"  
 IEEE Trans. Power Electron. vol. 18, no. 3, pp. 717-724, May, 2003
- [4] <http://www.circuitstoday.com/regulated-power-supply>
- [5]<http://www.talkingelectronics.com/Download%20eBooks/Principles%20of%20electronics/CH-17.pdf>
- [6] <http://www.math.rutgers.edu/~sontag/mct.html>

[7] <http://www.springer.com/engineering/control/journal/11768>

[8] <http://ieeexplore.ieee.org/xpl/RecentIssue.jsp?reload=true&punumber=4079545>

[9] <http://www.oxfordbibliographies.com/view/document/obo-9780195396607/obo-9780195396607-0091.xml>

[10] <http://aimsciences.org/journals/home.jsp?journalID=25>

[11] <http://www.chegg.com/homework-help/definitions/control-theory-49>

[12] <http://www.tvss.net/pq/har.htm>

[13] [www.aspowertechologies.com%2Fresources%2Fpdf%2FTotal%2520Harmonic%2520Distortion.pdf&ei](http://www.aspowertechologies.com%2Fresources%2Fpdf%2FTotal%2520Harmonic%2520Distortion.pdf&ei)

[14] <http://www.intechopen.com/books/power-quality-issues/harmonic-effects-of-power-system-loads-an-experimental-study>

[15] <http://www.powermonitors.com/download/file/WP87>

[16] <http://stereos.about.com/od/faqs/f/thd.htm>

[17] [https://www.princeton.edu/~achaney/tmve/wiki100k/docs/Total\\_harmonic\\_distortion.html](https://www.princeton.edu/~achaney/tmve/wiki100k/docs/Total_harmonic_distortion.html)



SANGYA THAKUR was born in RAIPUR, INDIA, in 1992. She is pursuing her B.TECH. degree in TeleCommunication engineering from SRM University Chennai.

She is the author of two papers,. Her research interests include electronics , microcontrollers , digital signal processing, control theory, communication networks.



PEEYUSH AGARWAL was born in New Delhi, INDIA, in 1993. He is pursuing his B.TECH. degree in Electronics And Communication engineering from SRM University Chennai.

He is the author of two papers, and three publications . His research interests include electronics, aerial robotics, control theory, communication networks.



ARVIND S.M was born in MUSCAT, OMAN, in 1993. He is pursuing his B.TECH. degree in Electronics And Communication engineering from SRM University Chennai.

He is the author of two papers, and three publications . His research interests include electronics, aerial robotics, control theory, communication networks.