

# Finite Element Modeling of High Strength Reinforced Concrete Slabs

[Mohamed Kandil, Khalid Heiza, and Moneir Soliman]

**Abstract**—The analysis of Reinforced Concrete (RC) structures by using finite element techniques takes great attentions through the last two decades. A lot of finite element packages like ANSYS, ABAQUS, COSMOS, Dyna-3D, and NASTRAN have been modified to be used in the analysis of different elements of RC structures. In this paper ANSYS finite element software was used to analyze the structural behavior of high strength RC slabs. The analysis of RC slabs was considered in three dimensions finite element analysis, where effects of material and geometric nonlinearities were taken into consideration to increase the accuracy of the results. Flexural capacity of RC slabs was measured experimentally and calculated analytically using ANSYS. Comparisons between experimental and analytical results were performed. Comparisons between typical cracks patterns and modes of failure were comparable.

**Keywords**— Flexural capacity, High strength concrete, Material nonlinearities, Reinforcement ratio, Silica fume, Deflection, Finite element, ANSYS.

## I. Introduction

The beginnings of the finite element method surfaced in the early 1940s but it was not became a concept until the 1960s. Nowadays, the finite element method is the most accepted technique for numerical analysis in structural mechanics (or in civil engineering structures). The finite element method is essentially a means to finding an approximate solution to partial differential equations. ANSYS is a complete FEA software package used by engineers worldwide in virtually all fields of engineering, like structural, electrical, mechanical and electromagnetic. Saifullah et al., and Nguyen et al. [1-2] used ANSYS analysis to make comparisons between experimental and analytical investigations of flexural behavior of reinforced concrete elements. Salah Kh [3] used 2-D finite element analysis to describe the structural behavior of reinforced concrete beams. Since the comparison of obtained results indicated that main reinforcement, strengths of concrete, stress yielding of steel may affect the ductility of RC beams [3]. Heiza et al. [4] used 2-D and 3-D finite element analysis for high strength concrete flat slabs. Masti et al. [6] studied the nonlinear behavior of high strength concrete flexural beams, using 2-D and 3-D ANSYS. The comparison of load-deflection, load-concrete strain and energy observed diagrams of tested beams and numerical results made by ANSYS modeling are in a good agreement [5]. Tayel et al. [6] made a comparison between analytical and experimental behavior of cantilever RC concrete slabs with opening.

---

Mohamed Kandil, Khalid Heiza, and Moneir Soliman  
Civil Engineering Department / Faculty of Engineering of Shebin El-kom /  
Menoufia University  
Egypt.

The study was beneficial in determining the length of the cantilever and the maximum dimensions of the opening relative to the RC slab dimensions. Many researchers found that experimental results were very close to the results obtained for finite element model using ANSYS [7-11].

## II. Research Significance

Execute a theoretical 3D model in order to investigate the behavior of high strength reinforced concrete slabs supported on four columns under the variation of Reinforcement ratios for group (A) and having different central opening size for group (B). Finally check the validity and the accuracy of the finite element modeling used in this study to predict the behavior of the high strength reinforced concrete slabs.

## III. Methodology of Finite Element Analysis Using ANSYS

The FEM is a computer aided mathematical technique for obtaining approximate numerical solutions to the abstract equations of calculation that predict the response of mechanical structural or physical systems subjected to external influences. The finite element method is an approximate technique, and as such, results computed using the finite element method must be critically evaluated before relied upon in a design application. The number of elements used in a model can greatly affect the accuracy of the solution. In general, as the number of elements, or the fineness of the mesh, is increased, the accuracy of the model increases as well.

### A. Reinforced Concrete Elements

An eight-node solid element (Solid65) was used to model the concrete. The solid element has eight nodes with three degrees of freedom at each node – translations in the nodal x, y, and z directions. The element is capable of plastic deformation, cracking in three orthogonal directions, and crushing. The geometry and node locations for this element type are shown in Figure (1) [8 and 12]. Requires input data for reinforced concrete were as follows [13 and 14]: Elastic modulus ( $E_c$ ) = 35474 MPa, ultimate uniaxial compressive strength ( $F_{cu}$ ) = 65 MPa, ultimate uniaxial tensile strength ( $f_r$ ) = 4.4 MPa, Poisson's ratio ( $\nu$ ) = 0.2, and shear transfer coefficient ( $\beta_t$ ) = 0.2.

## B. Steel Reinforcement Elements

Three techniques were used to model steel reinforcement in finite element models for reinforced concrete. See figure (2), where the discrete model, the embedded model, and the smeared model are illustrated. The reinforcement in the discrete model was shown in Figure (2-a) shows the bar or beam elements (Link 8) that are connected to concrete mesh nodes. Therefore, the concrete and the reinforcement mesh share the same nodes and concrete occupies, the same regions occupied by the reinforcement [12-14]. Requires input data for steel reinforcement were as follows [13 and 14]: Elastic modulus ( $E_s$ ) = 210000 MPa, yield stress ( $f_y$ ) = 240 MPa, and poisson's ratio ( $\nu$ ) = 0.3.

## iv. Experimental Work

### A. Details of Test Slabs:

#### Group (A): High Strength RC Slabs with Different Steel Reinforcement Ratios:

Heiza et al [4] had tested five high strength RC square slabs with dimensions 1200 mm × 1200 mm × 70 mm with different steel reinforcement ratios were considered in this investigation as follows:

- Slab (HSR1) has a steel reinforcement ratio ( $\mu$ ) of 0.43 %.
- Slab (HSR2) has a steel reinforcement ratio ( $\mu$ ) of 0.57 %.
- Slab (HSR3) has a steel reinforcement ratio ( $\mu$ ) of 0.72 %.
- Slab (HSR4) has a steel reinforcement ratio ( $\mu$ ) of 0.87 %.
- Slab (HSR5) has a steel reinforcement ratio ( $\mu$ ) of 1.08 %.

All RC slabs had the same compressive strength  $F_{cu}=65\text{N/mm}^2$ . Figure (3) and (4) shows dimensions of a typical test RC slabs and it reinforcement details and also arrangement of dial gauges. Figure (5) shows the 3D finite element meshes for reinforced concrete slabs.

#### Group (B): High Strength RC slabs with different central opening size:

To investigate the effect of central square open size on the behavior of the high strength reinforced concrete slabs. Heiza et al [4] had tested five high strength concrete square slabs with dimensions 1200 mm × 1200 mm × 70 mm having different central opening sizes were considered as follows:

- Slab (HSO1) has no central opening.
- Slab (HSO2) has a central square opening size of 100 mm.
- Slab (HSO3) has a central square opening size of 200 mm.
- Slab (HSO4) has a central square opening size of 300 mm.
- Slab (HSO5) has a central square opening size of 400 mm.

These slabs had the same compressive strength and the same steel reinforcement ratio ( $F_{cu}=65\text{N/mm}^2$  and  $\mu=0.57\%$ ). Figure (6) and (7) shows dimensions of a typical test RC slabs and its reinforcement details and also arrangement of dial gauges. Figure (8) shows the 3D finite element meshes for reinforced concrete slabs.

## v. Results of Finite Element Analysis using ANSYS

### A. Load-Deflection Behavior for RC slabs using ANSYS

#### • Group (A):

Figure (9) shows the comparison between load - deflection curves of RC slabs HSR1, HSR2, HSR3, HSR4, and HSR5 at point (1) by ANSYS. It is clear that at the same RC slab loading conditions, compressive strength the reinforcement ratio has a clear effect on the flexural capacity of RC plates. As the reinforcement ratio increase the deflection decrease. For RC slab HSR1; the initial cracking load was (14 kN) and the ultimate load was (28 kN), the maximum deflection recorded at point (1) was 5.93 mm. For RC slab HSR2; the initial cracking load was (15 kN) and the ultimate load (29.6 kN), the maximum deflection recorded at point (1) was 4.07 mm. For RC slab HSR3; the initial cracking load was (17.5 kN) and the ultimate load was (30.4 kN), the maximum deflection recorded at point (1) was 4.97 mm. For RC slab HSR4; the initial cracking load was (18 kN) and the ultimate load was (35.7 kN), the maximum deflection recorded at point (1) was 5.50 mm. For RC slab HSR5; the initial cracking load was (18 kN) and the ultimate load (35.7 kN), the maximum deflection recorded at point (1) was 4.70 mm. Figures (10) illustrate the contour lines in 3D for RC slab HSR1 at ultimate loads using ANSYS.

#### • Group (B):

Figure (11) shows the comparison between load - deflection curves of RC slabs HSO1, HSO2, HSO3, HSO4, and HSO5 at points (1) by ANSYS. For RC slab HSO1; the initial cracking load was (22 kN) and the ultimate load (41 kN), the maximum deflection recorded at point (1) was 4.76 mm. For RC slab HSO2; the initial cracking load was (21 kN) and the ultimate load (41 kN), the maximum deflection recorded at point (1) was 4.81 mm. For RC slab HSO3; the initial cracking load was (19 kN) and the ultimate load (39.73 kN), the maximum deflection recorded at point (1) was 5.06 mm. For RC slab HSO4; the initial cracking load was (18.5 kN) and the ultimate load (37.5 kN), the maximum deflection recorded at point (1) was 4.71 mm. For RC slab HSO5; the initial cracking load was (18 kN) and the ultimate load (36.15 kN), the maximum deflection recorded at point (1) was 5.99 mm. Figures (12) illustrate the contour lines in 3D for RC slab HSO5 at ultimate loads using ANSYS.

## vi. Comparison for load deflection between ANSYS and Experimental results

#### • Group (A):

Figure (13) shows comparison of load deflection diagram between ANSYS and experimental work at point 1 at the center of the slab. For RC slab HSR1; it is noticed that the difference between experimental results and ANSYS results

were 0.0%, 0.0%, and 2.7% for initial cracking load, ultimate load, and maximum deflection respectively. For RC slab HSR2; it is noticed that the difference between experimental results and ANSYS results were 6.2%, 7.5%, and 42.8% for initial cracking load, ultimate load, and maximum deflection respectively. For RC slab HSR3; it is noticed that the difference between experimental results and ANSYS results were 9.3%, 5.0%, and 10.2% for initial cracking load, ultimate load, and maximum deflection respectively. For RC slab HSR4; it is noticed that the difference between experimental results and ANSYS results were 12.5%, 5.0%, and 13.1% for initial cracking load, ultimate load, and maximum deflection respectively. For RC slab HSR5; it is noticed that the difference between experimental results and ANSYS results were 10%, 5.3%, and 6.3% for initial cracking load, ultimate load, and maximum deflection respectively.

• **Group (B):**

Figure (14) shows comparison of load deflection diagram between ANSYS and experimental work at point (1) at a distance 30 cm from the plate edge for RC slab HSO1; it was noticed that the difference between experimental results and ANSYS results were 0.0%, 2.4%, and 6.7% for initial cracking load, ultimate load, and maximum deflection respectively. For RC slab HSO2; it was noticed that the difference between experimental results and ANSYS results were 5%, 2.4%, and 7.7% for initial cracking load, ultimate load, and maximum deflection respectively. For RC slab HSO3; it was noticed that the difference between experimental results and ANSYS results were 5.5%, 0.01%, and 11.4% for initial cracking load, ultimate load, and maximum deflection respectively. For RC slab HSO4; it was noticed that the difference between experimental results and ANSYS results were 2.8%, 6.2%, and 32.5% for initial cracking load, ultimate load, and maximum deflection respectively. For RC slab HSO5; it was noticed that the difference between experimental results and ANSYS results were 2.7%, 9.6%, and 12.4% for initial cracking load, ultimate load, and maximum deflection respectively.

A. **Figures and Tables**

TABLE I. MIX PROPORTIONS OF CONCRETE USED [4]

Mix for Specimen	Mix proportions (kN / m <sup>3</sup> )						C28 Mpa	A/(C+S)%	(S/C)%	W/(C+S)%	C.A. / F.A.
	A mix	S . f	Dolomite	Sand	W	C					
All slabs	0.12	0.68	11.74	5.87	1.4	4.5	65	239	15	27	2

C: Cement, W: Water, F.A.: Fine aggregate sand, C.A.: Course aggregates

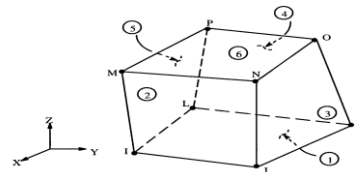

Figure 1. Solid 65 – 3-D reinforced concrete solid element used for concrete

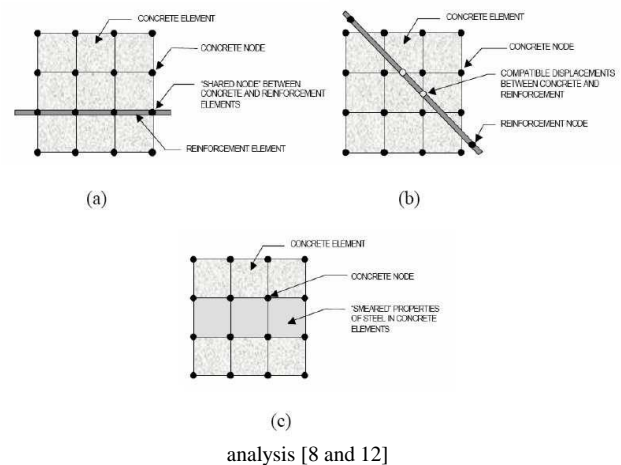

Figure 2. Models for reinforcement in reinforced concrete; (a) Discrete; (b) Embedded; (c) Smearred [12]

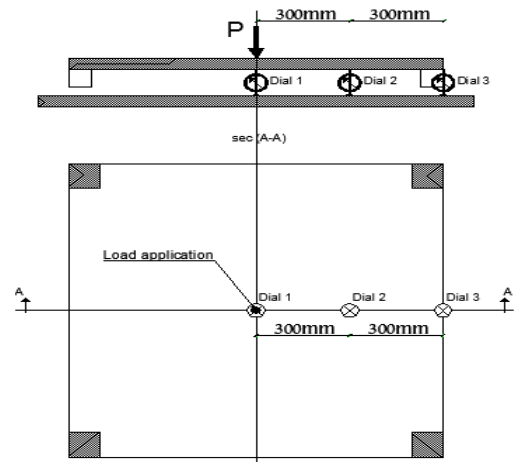

Figure 3. Shows dimensions of typical test RC slabs and arrangement of dial gauges of group (A)

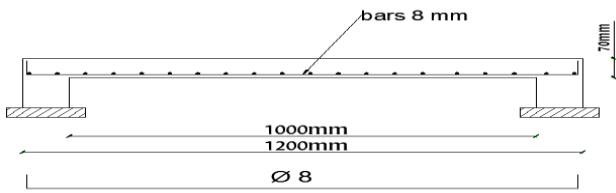

Figure 4. Shows Reinforcement of typical test RC slabs of group (A)

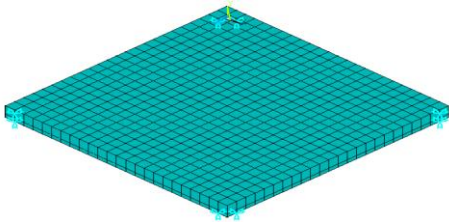

Figure 5. 3D finite element meshes for RC slabs of group (A).

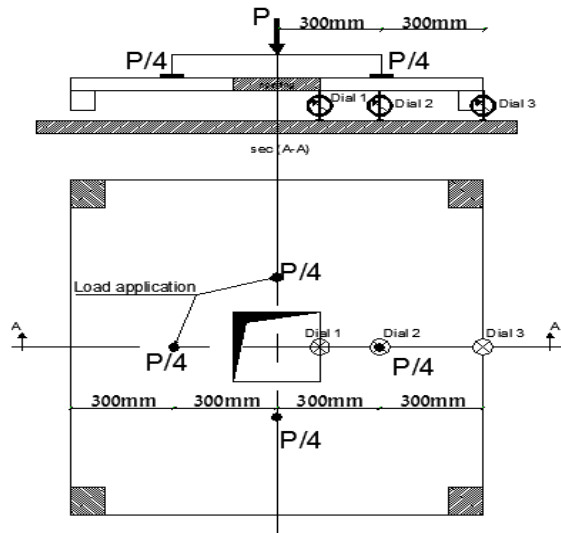

Figure 6. Shows dimensions of typical test RC slabs and arrangement of dial gauges of group (B)

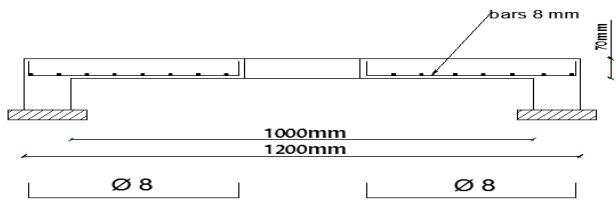

Figure 7. Shows Reinforcement of typical test RC slabs of group (B)

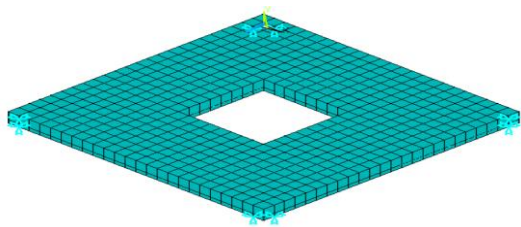

Figure 8. 3D finite element meshes for RC slabs of group (B).

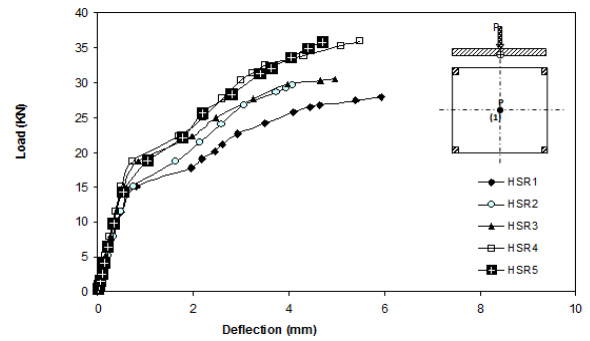

Figure 9. Comparison between Load - Deflection Curves of all RC Slabs of group (A) at Point (1) by ANSYS.

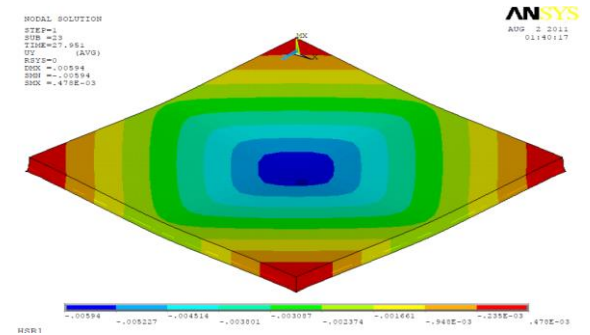

Figure 10. Deflection Contour lines for RC slab HSR1 in m using ANSYS

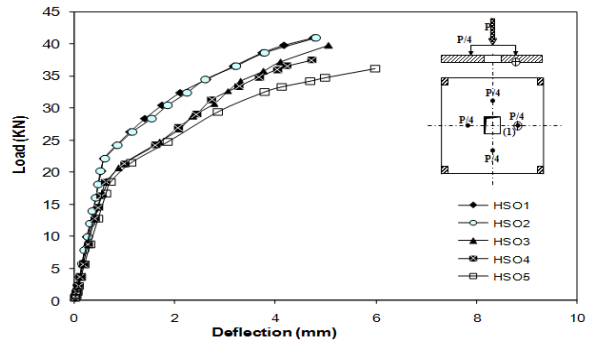

Figure 11. Comparison between Load - Deflection Curves of all RC Slabs of group (B) at Point (1) by ANSYS.

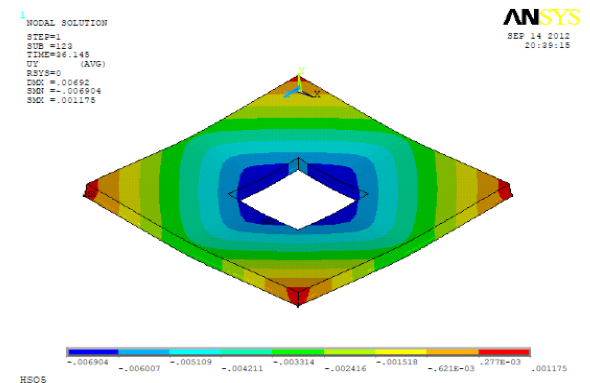

Figure 12. Deflection Contour lines for RC slab HSO5 in m using ANSYS

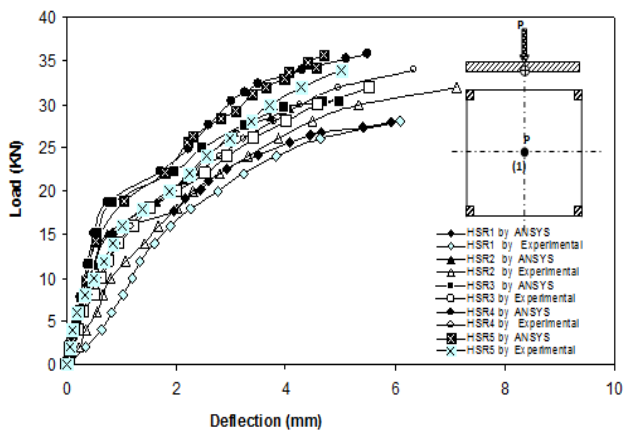

Figure 13. Comparison between experimental and analytical values from ANSYS for Load - Deflection Curves of RC Slabs of group (A) at Point (1).

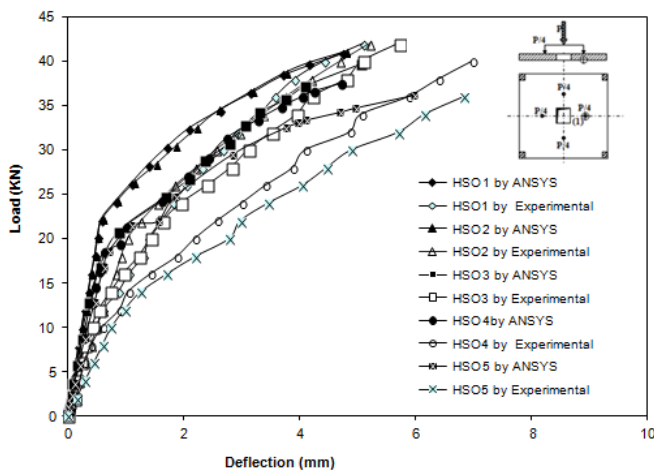

Figure 14. Comparison between experimental and analytical values from ANSYS for Load -Deflection Curves of all RC Slabs of group (B) at Point (1).

### Conclusions

From the experimental and theoretical investigation carried out in this study it can be concluded that:

- The nonlinear three dimensional finite element model used in this study predict with acceptable accuracy the structural behavior of the high strength RC slabs.
- RC Slabs recorded approximately the same deflection values in the linear part before cracking and after the linear part, the higher reinforcement ratio the lower deflection values.
- There is a quite agreement and harmony between all experimental and theoretical results by using ANSYS, especially till the initial cracking loads.
- Load – deflection curves of all RC plates at different locations were linear till first cracking load. After cracking, deflections increased rapidly as the load increased.

- As steel reinforcement ratio ( $\mu$ ) increases, plate stiffness, and flexural capacity increase with decrease in the deflection values.

### References

- Saifullah, I., Zaman, M. Uddin, S. M. K., Hossain, M. A and Rashid, M. H. "Experimental and analytical investigation of flexural behavior of reinforced concrete beam" International Journal of Engineering & Technology IJET-IJENS Vol: 11 No. 01. pp 188-196. 2011.
- Ngugen, V. H., Thai, T. H., Luu. Q. T., Bui, T. T and Luu, C. H. "Finite element analysis for various structures made of classic and composite materials by using ansys software" Journal of Science & Technology, Vol. 55-2006.
- Salah, Kh., "2D FE description of reinforced concrete beams behavior" Journal of Engineering and Applied Sciences. No. 3(1) pp 7-15. 2008.
- Heiza Kh. M., N. Meleka, Tayel M. and Farah N. "Behavior of high strength reinforced concrete flat slabs using nonlinear finite element analysis" Engineering Research Journal. Vol. 28, No. 1, pp 79-93 Jan. 2005.
- Masti, K., Maghsoudi, A. A and Rahgozar, R. "Nonlinear models and experimental investigation of life time history of HSC flexural beams" American Journal of Applied Sciences. Vol. (5) No. (3) : pp 248-262, 2008.
- Tayel, A. M., Soliman, H. M. and Ragi, S. A. "Experimental behavior of cantilever reinforced concrete plates with opening" ERJ. Vol. 26 No. 1, 2003
- Luca, S. Constantinnides, G. Franz, J. U., and Toutlemonde "The nano-mechanical signature of ultra high performance concrete by statistical nano indentation techniques" Cement and Concrete Research. Vol. 38. pp 1447-1456 2008.
- Curpreet stigh. " Finite Element analysis of reinforced concrete shear walls", M.sc. Theses department of civil engineering, Deemed University, India 2006.
- Heiza M. Kh. " Finite Element analysis of reinforced continuous beams strengthened by external layers", The journal of American science, 7 (10). 2011.
- Heiza M. Kh., N. N. Meleka, N. Y. Elwkad. " Behavior and Analysis of Self-Consolidated Reinforced Concrete Deep Beams Strengthened in Shear", ISRN Civil Engineering, vol. Article ID 202171. 2012.
- Heiza M. Kh. "New Finite Element Approach for Reinforced Concrete Beams", Magazine of Concrete Research, Vol. 65, No. 2. 2012.
- Saeed moaveni. "Finite element analysis theory and applications with ansys" CRC Press, Fifth Edition, 2010.
- Khaled M. Heiza, Mounir H. Soliman and Mohamed Kandel, "Finite Element Modelling of Strengthened RC Plates Using ANSYS", CIC June 2014, Oslo, Norway.
- Kandil A. M., "Finite Element Modeling of Reinforced Concrete Structures Strengthened with FRP System" M.Sc. Civil Engineering Department, Faculty of Engineering, Minufiya University, Egypt. 2012.



Using Finite Element Modeling enables us to predict the results of experimental work before starting, which lead to minimize the cost of laboratory work