

Mode Shape Vibration Analysis of Truck Transmission Housing Based on FEA

Ashwani Kumar, Himanshu Jaiswal, Anish Anand, Pravin P Patil

Abstract— The main objective of this research work is to find the natural frequency and mode shape of truck transmission housing. Truck transmission housing or gearbox transmission casing is subjected to vibration induced by the excitation forces transmitted to the casing through bearings. So it is required to find the natural frequency for the accurate prediction of housing life and prevent it from fracture. Housing is made of various materials like cast iron and Al alloys. In present few composites are also available for the manufacturing of casing. The vibration analysis of transmission housing was performed by finite element simulation using ANSYS 14.5 software. The vibration mode shapes for first twenty modes were studied. The results show that the natural frequency of vibration varies from 1306.3 Hz to 3879 Hz. The analysis results were verified with experimental result available in literature. Solid Edge software is used for the designing of transmission housing and FEA based ANSYS 14.5 software is used for the free vibration analysis of transmission housing.

Keywords— Truck Transmission, Housing, FEA, Structural Steel, Natural Frequency.

I. Introduction

Automobile transmission gearbox were subjected to harmonic excitation and meshing excitation which brings vibration and noise of automobile vehicles. The study of dynamic characteristics of transmission is important to reduce the vibration and noise. The varying loading and boundary conditions produces noise and vibration. Various types of damping material like cast iron are used to eliminate and absorb the vibration waves [2-3].

Structural steel is also used as a transmission housing material for different types of heavy machinery. In this research work we have selected structural steel as a transmission housing material and analyzed its suitability on the bases of vibration criteria. This study of structural steel is purely based on design and vibration analysis without considering the manufacturing prospects.

Ashwani Kumar

Himanshu Jaiswal

Pravin P Patil

Department of Mechanical Engineering, Graphic Era University Dehradun
India, 248002

Once the material is suitable on design and vibration bases we can further extend our study for manufacturing consideration of structural steel as a vehicle transmission housing material. Noise and vibration are the two technical indexes for the transmission failure so vibration is selected as a study parameter. Researchers have done various studies on dynamic response of transmission system since past two decades, but it is a very complex procedure in term of design, measurement or mathematical modeling.

Automobile transmission system is a combination of gears to meet the torque variation for the varying speed conditions. Transmission system can be classified in three types- Automatic, manual and continuously variable transmission. The simplest type of transmission is manual. Manual transmission is of two types: sliding mesh and constant mesh. The main reason of noise and vibration is wrong shifting of gears, uneven road surfaces, loose fixturing of transmission gears, components and housing. Clashing is the general phenomena that occur during shifting of gears. Clashing is a loud noise produced during collision of gear tooth and this collision leads the transmission failure. In others two types of transmission automatic and continuously variable transmissions there is less driver interaction [4-5]. Slack in drive train mechanism produces high vibration known as transmission shock. Transmission shock is the high grade of vibration that may cause the failure of housing [7-8].

Jiri Tuma [9] has studied the noise and vibration of transmission system. The author solved the gear noise problem by introducing an enclosure to reduce radiated noise. TARA trucks have been selected as a research object. The Fourier Transform is used for the analytical analysis. Analytical result is verified using experimental investigation. The extensive noise is produced during the tooth meshing or at structural resonance frequency. The natural frequency of vibration is varying in between 500 Hz to 3500 Hz at varying rpm. The severe vibration occurs at the frequency range of (500-2500) Hz. Our results show that the natural frequency of vibration varies from 1002.5 Hz to 2954.8 Hz, which is verified by Jiri Tuma results. Mats Åkerblom [10] has performed a literature review and concluded that transmission error is an important excitation mechanism for gear noise and vibration. In addition to transmission error, friction and bending moment are another reason responsible for failure. He has also analyzed the dynamic behaviour of a gearbox.

Shawki S et al. [11] have used vibration response analysis method for the analytical analysis of car gearbox system. He

has performed analytical and experimental analysis of a car transmission system. By using physical properties he has calculated the radiation efficiency, and the vibration response of the gearbox structure surface was measured using accelerometers. Fujin Yu et al. [12] have studied the dynamic characteristic of the automobile transmission gearbox. They have used structural optimization method to reduce the noise and vibration of gearbox. Pro/E and finite element method is used for the analysis.

Leila et al. [13] have studied the heavy gearbox of helicopters. To prevent break down and accident in helicopters gear fault detection is important. Spectrum analysis and Cepstrum analysis method is used to identify damage gear. Fourier analysis is used for analytical results. Timothy J et al. [14] have studied the source of vibration. A Sports Utility Vehicle with sensor and data acquisition system is used to find the vibration source. This study was focused on vehicle vibration response from road surface features. Chinmaya at al. [15] have used motor current signature analysis (MCSA) and discrete wavelet transform (DWT) for studying the gear vibration. Load fluctuations on the gearbox and gear defects are two major sources of vibration. P. Czech [16] has described the vibroacoustic diagnostics of high-power toothed gears. The presented analysis is a experimental work done in a steel plant. Time-frequency, Scale-frequency and frequency-frequency analysis were used for vibroacoustic diagnostics. R. Singh [17] has done two case studies for the vibro-acoustic analysis of automotive structures. Analytical and experimental results are presented for brief description. In first case passive and adaptive hydraulic engine mounts and in second case welded joints and adhesives in vehicle bodies were considered.

II. The Cad Model

Solid Edge [6] software has good features for complex geometry modeling. We have constructed the geometry by taking measurement in workshop. Various components are not taking into consideration because it has very less impact on vibration. The CAD model is shown as figure 1. For frequency analysis finite element based software ANSYS 14.5 [1] has been selected as a analysis tool. After uploading the geometry in ANSYS, it is discretized in small elements. These elements are connected at a point known as node. This process is known as meshing. Figure 2 shows the meshed model of transmission housing. ANSYS 14.5 have high quality meshing facility. It is decided by the counting of nodes and elements, various others factors also play a important role in meshing. The meshed model consists of 2,52,786 nodes and 1,56,307 elements. Linear tetrahedral elements are used for meshing.

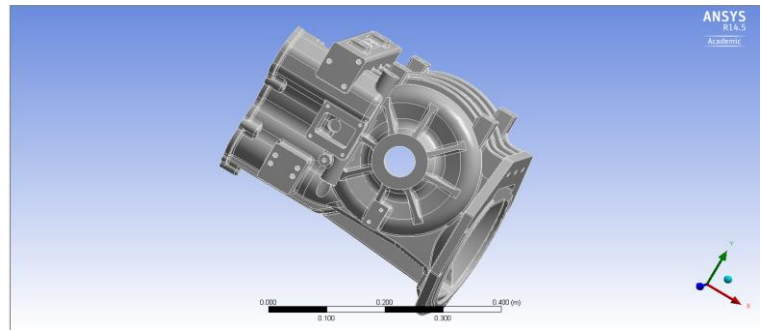

Figure.1. Cad Solid model of Transmission Casing.

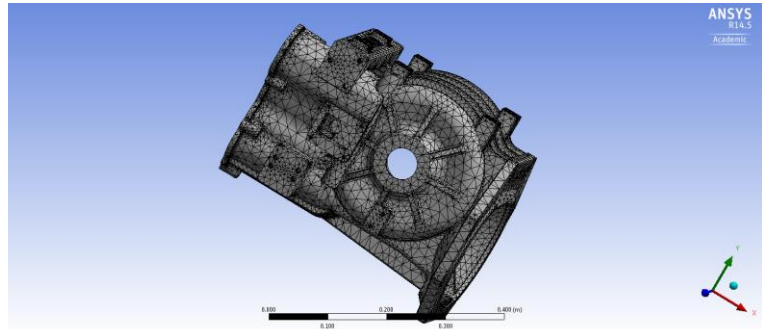

Figure.2. Meshed Model of Transmission Casing in ANSYS 14.5

III. Material Properties and Boundary Conditions

Transmission housing is manufactured by casting process in two parts known as upper and lower half symmetrical about shaft axes. Housing is mounted on truck frame using bolts. Loosing of bolts may cause serious vibration. Since past many decades cast iron is used for the transmission housing , we have used structural steel as a housing material for the truck transmission without considering manufacturing prospects. The Mechanical properties (Elastic modulus, Poisson ratio and density) are required for free vibration analysis. The material properties selected for the study of the transmission housing are Elastic modulus – 2.0×10^{11} Pa, Poisson ratio- 0.30, density-7850 kg/m³ [1]. Structural steel is available as a engineering material in the material library of ANSYS 14.5.

After selecting the material the next step is boundary conditions. There are two predefined boundary condition in ANSYS for modal or free vibration analysis. These are free-free and fixed-fixed boundary conditions. In free-free boundary conditions all degree of freedom are unconstraint. Fixed- fixed boundary condition is suitable for the housing analysis because housing is constraint on frame by bolts. To provide the fixed- fixed boundary condition we have fixed the hole of bolts so that it behaves as a actual model in software environment.

IV. Results and Discussion

ANSYS solver is used to calculate the natural frequency and evaluate the mode shape of transmission housing. Mathematical simulation is performed for fixed – fixed boundary conditions. In free vibration analysis using ANSYS the load is selected automatic by solver. The first 20 natural frequency (Table 1) and different mode shapes (figure 3) have been obtained. There are different vibration patterns (torsional, bending, axial bending vibration and combination of two vibration) in free vibration analysis. Mode 1, 3 and 5 is torsional vibration. This torsional vibration is performed at single left side on transmission housing. Axial bending vibration has been find in 8, 10 and 12 modes. In axial bending vibration body bend from the center line figure 3. The 18 and 20 modes is axial bending vibration with torsional vibration. Both axial bending and torsional vibration happen in upper and lower side. Figure 3 shows the different mode shapes and corresponding natural frequency. The range (1002.5-2954.8) Hz of natural frequency for structural steel analysis is in the same range (500-3500) Hz as the experimental result obtained by the Jiri Tuma [9]. These analysis results were verified with experimental result available in literature Jiri Tuma [9]. In case the bolt is loose or failed the transmission housing will vibrate heavily and the transmission system will break down.

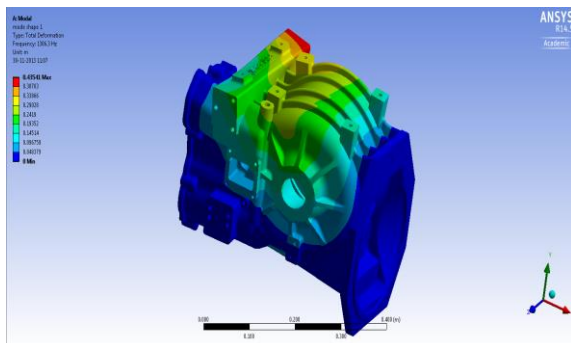

Mode 1 $f_1 = 1306.3$ Hz

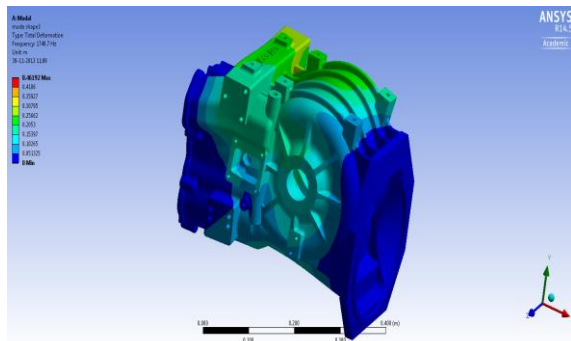

Mode 3 $f_3 = 1740.7$ Hz

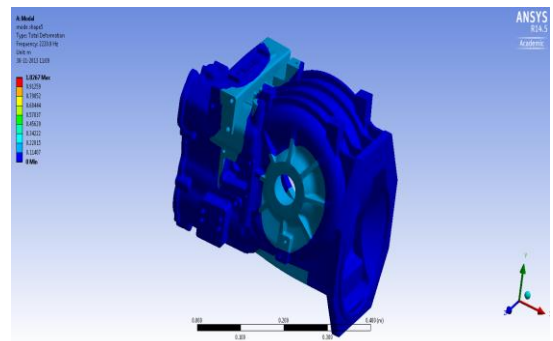

Mode 5 $f_5 = 2220.9$ Hz

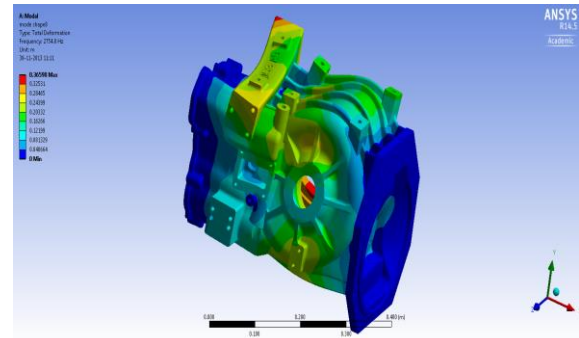

Mode 8 $f_8 = 2754.8$ Hz

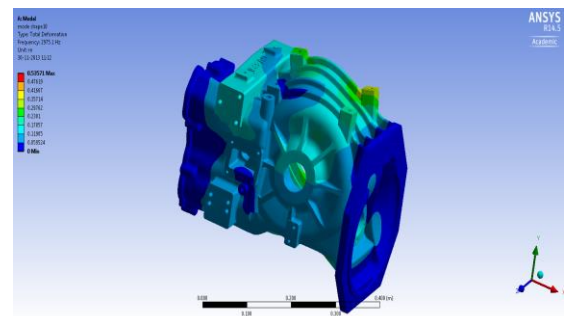

Mode 10 $f_{10} = 2975.1$ Hz

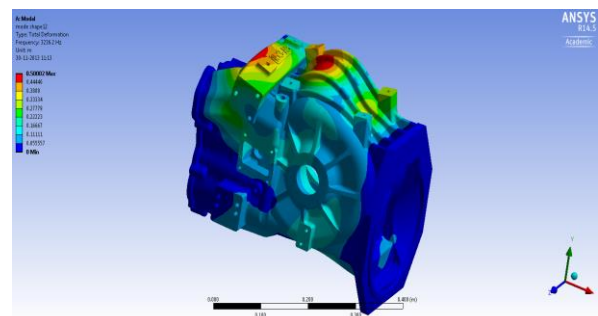

Mode 12 $f_{12} = 3236.2$ Hz

Table. 1 Mode number and corresponding natural frequency.

Mode Number	Natural Frequency (Hz)
1	1306.3
2	1463.7
3	1740.7
4	2220.9
5	2220.9
6	2352
7	2495.7
8	2754.8
9	2803.8
10	2975.1
11	3006
12	3236.2
13	3240.9
14	3526.8
15	3594.2
16	3605.9
17	3698.9
18	3754.3
19	3760.4
20	3879

v. Conclusion

Heavy vibration excitation, clashing and loosing fixtures is the main reason for transmission housing failure. In external excitation if excitation frequency coincides with the natural frequency of transmission it may cause resonance. External excitation on the transmission must be prevented in order to prevent the fracture or breakage of transmission structure. Analysis results shows that transmission housing is subjected to Axial bending vibration, torsional vibration and axial bending with torsional vibration. The transmission housing motion is constrained by constraining the displacement of bolt holes. ANSYS14.5 software has powerful analysis capabilities and SOLIDEDGE software has a powerful function of solid modeling. They are suited for Finite Element Analysis of complex shapes. The 3D solid model is prepared by applying SOLIDEDGE software and is transferred to ANSYS 14.0. In this research work we have considered the vibration problem of the transmission housing using FEA method for structural steel. The FEA result shows that on design and vibration index structural steel can be used as truck transmission housing without considering the manufacturing prospects. Finite Element Analysis offers satisfactory results. First 20 Vibration mode shape has been calculated. The analytical result is verified with the experimental result available in the literature.

References

- [1] ANSYS R 14.5. Academic, Structural analysis Guide 2013.
- [2] Fan Qin-man, " Modal Analysis of a Truck Transmission Based on ANSYS" , Fourth International Conference on Information and Computing 2011. 978-0-7695-4378-9/11 \$26.00 © 2011 IEEE DOI 10.1109/ICIC.2011.75
- [3] Huang Minfeng, Jiang Yingchun, " Fatigue life analysis of automobile component based on FEM" , Mechanical Research and Application. Vol 21, pp 57-60,2008.
- [4] Liu De-gang, HOU Weixing, WANG Fengzhou, " Fatigue Life Analysis of a Component Based on the Finite Elements Technology" , Journal of The China Railway Society vol. 26, pp 47-51, 2004.
- [5] Saada A, velex P, "An extended model for the analysis of the dynamic behavior of planetary trains" , ASME Journal of Mechanical Design vol. 117, pp 241-247, 1995.
- [6] SOLIDEDGE .Version 19.0 , 2006.

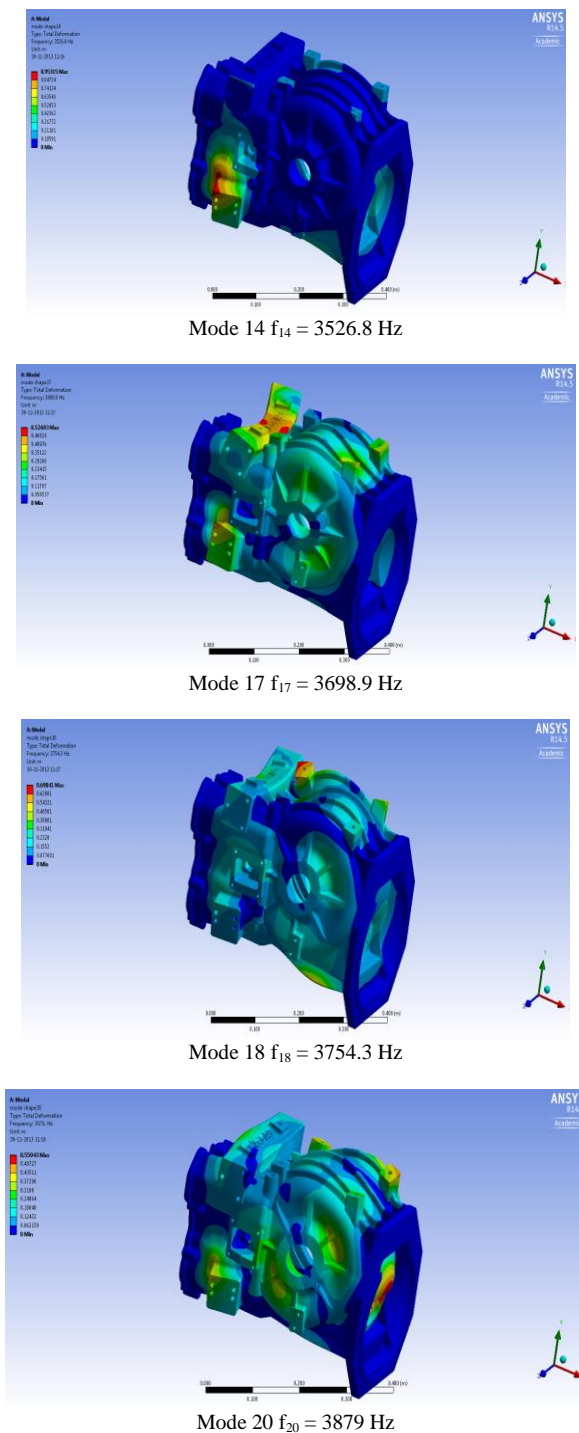

Figure 3. Ten different mode shape of the Transmission Casing

- [7] Velex P, Flamand L, “ Dynamic response of planetary trains to mesh parametric excitations” , Journal of Mechanical Design. Transactions of the ASME Vol 118, pp 7-14,1996.
- [8] Yu Li, Wu Guangqiang , “ Analysis on Fatigue Life of Rear Suspension Based on Virtual Test Tig” , Computer Aided Engineering vol. 15, pp 128-130,2006.
- [9] Jiri Tuma , “ Gearbox Noise and Vibration Prediction and Control” , International Journal of Acoustics and Vibration Vol. 14, pp 1-11, 2009.
- [10] Mats Åkerblom. Gear noise and vibration - a literature survey. Report-Volvo Construction Equipment Components AB.
- [11] Shawki S. Abouel-Seoud, Eid S. Mohamed, Ahmed A. Abdel-Hamid and Ahmed S. Abdallah, “Analytical Technique for Predicting Passenger Car Gearbox Structure Noise Using Vibration Response Analysis” , British Journal of Applied Science & Technology Vol. 3, pp 860-883, 2013.
- [12] Fujin Yu, Yongxiang Li, Daowen Sun, Wenquan Shen and Weiqiang Xia, “Analysis for the Dynamic Characteristic of the Automobile Transmission Gearbox”, Research Journal of Applied Sciences, Engineering and Technology, vol. 5, pp 1449-1453, 2013.
- [13] Leila.Nacib, Komi Midzodzi.Pekpe and Saadi Sakhara, “Detecting gear tooth cracks using cepstral analysis in gearbox of helicopters”, International Journal of Advances in Engineering & Technology Vol. 5,pp.139-145, 2013.
- [14] Timothy J. Gordon and Zevi Bareket, “Vibration Transmission from Road Surface Features – Vehicle Measurement and Detection” Technical Report for Nissan Technical Center North America, Inc. 2007, UMTRI- 2007-4.
- [15] Chinmaya Kar and A.R. Mohanty, “Monitoring gear vibrations through motor current signature analysis and wavelet transform” , Mechanical Systems and Signal Processing Vol. 20, pp. 158–187, 2006.
- [16] P. Czech, “Diagnosis of industrial gearboxes Condition by vibration and time-frequency, Scale-frequency, frequency-frequency analysis” Metalurgija, Vol. 51 pp. 521-524, 2012.
- [17] R. Singh. Dynamic design of automotive systems, “Engine mounts and structural joints” , Dynamic design of automotive systems Vol. 25, pp. 319-330, 2000.