

# Smart Antenna Beamforming using LMS Adaptive Filter Algorithm

Jasdeep Singh, Abhishek Pal

**Abstract**— Adaptive filters are novel kind of filters used in Digital Signal Processing with adjustable weights. The weight adjustment in adaptive filters is done using some special kind of algorithms called as adaptive algorithms. Adaptive filters have a number of applications in various fields like signal processing, communication systems biomedical etc. One of the novel applications of Adaptive filters is in Smart Antenna Beam formation. Smart antenna is an antenna system used in wireless communication, with array of antenna elements having adjustable weights. By optimizing or adjusting the weights of adaptive antenna array the beam of antenna can be directed towards desired users and a null of beam can be placed toward undesired users thus enhancing the capacity of the system. The adjustment of weights is carried out using Adaptive Filter algorithms. In this paper, we have used LMS algorithm for beam formation in smart antenna.

**Keywords**— Smart antenna, LMS algorithm, beamformation, adaptive algorithms

## I. Introduction

Adaptive filters are used in Digital Signal Processing since recent two or three decades. These filters have unique property that they have adjustable coefficients or weights, so that for a given input data a desired output response can be obtained according to the requirement. The weight adjustment in adaptive filters is done using some special kind of algorithms called as adaptive algorithms. The most common adaptation algorithms are, Recursive Least Square (RLS), and the Least Mean Square (LMS) [1], [2], in which RLS algorithm offers a higher convergence speed compared to the LMS algorithm, but as for computation complexity, the LMS algorithm maintains its advantage [3]. Some of the other algorithms which have been derived from these basic algorithms are optimized-LMS algorithm, constant modulus algorithm (CMA), least square constant modulus algorithm (LS-CMA), sample Matrix Inversion (SMI) algorithm Interference Normalize Least Mean Square (INLMS) algorithm [4], [5], [6], [7]. Adaptive filters are used in various applications like:

(1) for equalization of ISI and for channel Identification; (2) for noise cancellation; (3) for estimation of characteristics of unknown systems; (5) in Jammer suppression, as a powerful tool for the rejection of narrowband interference in a direct sequence spread spectrum receiver; (7) for bio-medical like fetal monitoring, cancelling of maternal ECG during labor etc.

One of the novel applications of Adaptive filters is in Smart Antenna Beam formation. Smart antenna or Adaptive antenna is novel kind of antenna system used in wireless communication, with array of antenna elements having adjustable weights. By optimizing or adjusting the weights of adaptive antenna array the beam of antenna can be directed towards desired users and a null of beam can be placed toward interfering or undesired users. The weight of the antenna elements is adjusted using various Adaptive Filter algorithms. In in term paper, we have shown the beam formation of smart antenna using LMS algorithm. At last the results and simulations using MATLAB are given in the form of different cases for beam formation.

## II. Smart Antenna Systems

Small antenna systems are the novel kinds of antenna used in wireless communication systems in order to enhance the capacity of the system. Smart antenna generally refers to any antenna array, consisting of a sophisticated Digital Signal Processing system, which can adjust or adapt its own beam pattern in order to emphasize signals of interest and to minimize interfering signals. Smart antennas can provide higher system capacities, increase signal to noise ratio, reduce multipath and co-channel interference by steering the main beam towards the user and at the same time forming nulls in the directions of the interfering signal [8].

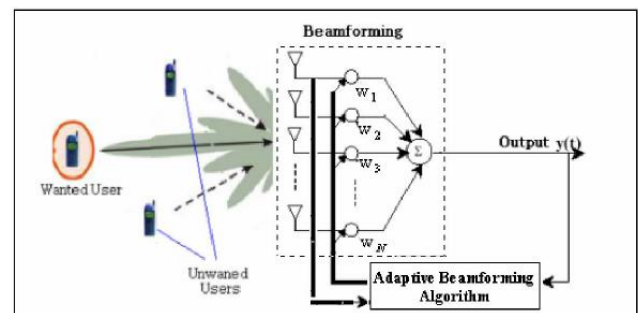

Figure 1: An illustration of Smart Antenna system [9]

A smart antenna system at the base station of a cellular mobile system is depicted in Figure 1. It consists of a uniform linear antenna array for which the current amplitudes are

Jasdeep Singh  
Student, Deptt. of Electronics Technology  
Guru Nanak Dev University  
Amritsar (Punjab)

Abhishek Pal  
Student, Deptt. of Electronics Technology  
Guru Nanak Dev University  
Amritsar (Punjab)

adjusted by a set of complex weights using an adaptive beam forming algorithm. The adaptive beam forming algorithm optimizes the array output beam pattern such that maximum radiated power is produced in the directions of desired mobile users and deep nulls are generated in the directions of undesired signals representing co-channel interference from mobile users in adjacent cells. Prior to adaptive beam forming, the directions of users and interferes must be obtained using a direction-of-arrival estimation algorithm [9].

*Types of Smart Antenna Systems:*

According to transmit strategy there are two types of smart antenna systems: (1) Switched beam (2) Adaptive beam systems. A *Switched beam* antenna systems form multiple fixed beams with heightened sensitivity in particular directions. These antenna systems detect signal strength, choose from one of several predetermined, fixed beams, and switch from one beam to another as the mobile moves throughout the sector. On the other hand *adaptive antenna* systems approach communication between a user and base station in a different way, in effect adding a dimension of space. By adjusting to an RF environment as it changes (or the spatial origin of signals), adaptive antenna technology can dynamically alter the signal patterns to near infinity to optimize the performance of the wireless system. In this scenario, the interference rejection capability of the adaptive system provides significantly more coverage than either the conventional or switched beam system [10]. In simple words an adaptive antenna system can form beam in exactly same direction of the desired user while placing nulls in the directions of undesired users. Following diagram shows both switched and adaptive antenna systems.

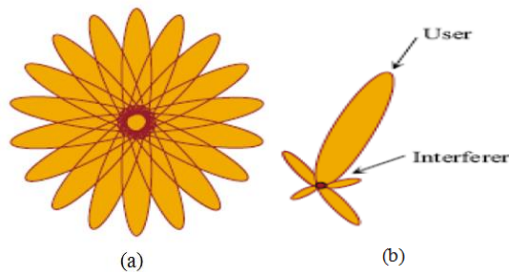

Figure 2: (a) Switched antenna; (b) Adaptive antenna

*Switched versus Adaptive Antenna system*

The comparison of beam formation by the two types of antenna systems is shown in figure 3.

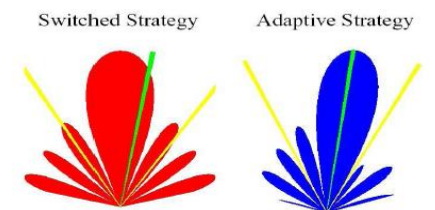

Figure 3- Switched versus Adaptive antenna

It is observed that the beam formation by an adaptive antenna array system is better than that of switched array, because it forms beam exactly in the same direction in which user is present, due to its ability to form infinite number of beams. In this paper we are basically focused on beam formation by Adaptive antenna.

**III. Model for Adaptive Beamforming**

An adaptive beam forming system can be obtained by an arrangement as shown in the figure 4 [11]. Here,  $S(t)$  represents the signal from desired user,  $I(t)$ 's are the signals from interferers,  $X(t)$ 's are the signals received by antenna elements, and  $y(t)$  is the output. The arrangement basically consists of:

1. An array of antenna elements placed spatially with respect to each other, they may be placed in either linear or in a planner geometry. In the diagram antennas are placed linearly with respect to each other.
2. Complex Weights represented as  $W$ , connected to each antenna element, which works as multiplication factors.
3. A summer for summing the weighted received signal, so as to generate the output signal after summation.
4. A DOA (Direction of Arrival) block to determine the direction of intended signal and the interfering signals, so that signal can be sent in that direction.
5. An Adaptive algorithm block, used for updating of weights, so as to get the radiation pattern in the desired direction.

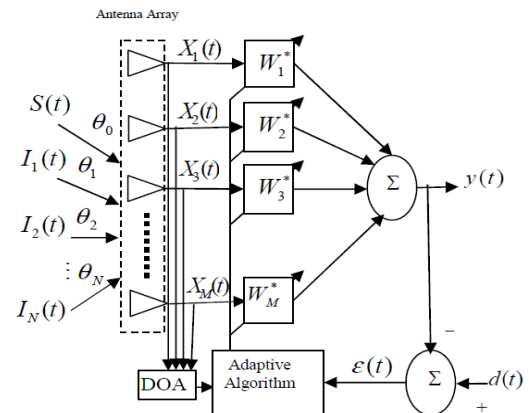

Figure 4: Adaptive beam forming [11]

*Working*

The digital signal processor interprets the incoming data, determines the complex weights (amplification and phase information) and multiplies the weights to each element output and optimizes the array pattern. The array thus produces maximum gain in the desired direction and the effect of noise and interference is minimized. The antenna array pattern is controlled via various adaptive beam forming algorithms based on different criteria for updating and computing the optimum weights. The efficiency and performance of the

smart antenna system is highly dependent on the adaptive algorithms used for digital beam forming.

#### IV. LMS Algorithm

It is one of the most simple, robust and effective algorithm. The arrangement for implementing LMS algorithm for smart antenna is shown in figure 5.

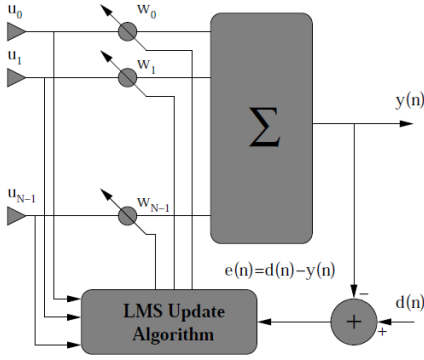

Figure 5: LMS algorithm [3]

As shown in the Figure, the outputs of the individual sensors are linearly combined after being scaled with corresponding weights optimizing the antenna array to have maximum gain in the direction of desired signal and nulls in the direction of interferers.

For beam former the output at any time  $n$ ,  $y(n)$  is given by is a linear combination of the data at  $M$  antennas, with

$$y(n) = \mathbf{w}^H(n)\mathbf{u}(n) \quad (1)$$

Here,  $\mathbf{u}(n)$  represents the input vector and  $\mathbf{w}(n)$  represents weights. Particularly  $\mathbf{w}(n)$  is given by

$$\mathbf{w}(n) = \sum_{n=0}^{M-1} w_n \quad (2)$$

Similarly,  $\mathbf{u}(n)$  is

$$\mathbf{u}(n) = \sum_{n=0}^{M-1} u_n \quad (3)$$

The LMS algorithm avoids matrix inverse operation and uses the instantaneous gradient vector  $\Delta J(n)$  for weight vector up gradation. The weight vector at time  $n + 1$  can be written as,

$$\mathbf{w}(n + 1) = \mathbf{w}(n) + \frac{1}{2}\mu[-\nabla J(n)] \quad (4)$$

where  $\mu$  is the step size parameter which controls the speed of convergence and it lies between 0 and 1. Very small values of  $\mu$  result in slow convergence and good approximation of the cost function; on the contrary large values of  $\mu$  may lead to a faster convergence but the stability around a minimum value may be lost.

An exact calculation of instantaneous gradient vector  $\Delta J(n)$  is not possible as prior information of covariance matrix  $\mathbf{R}$  and cross-correlation vector  $\mathbf{p}$  is needed. So an instantaneous estimate of gradient vector  $\Delta J(n)$  is,

$$\nabla J(n) = -2\mathbf{p}(n) + 2\mathbf{R}(n)\mathbf{w}(n) \quad (5)$$

Where,

$$\mathbf{R}(n) = \mathbf{u}(n)\mathbf{u}^H(n) \quad (6)$$

And,

$$\mathbf{p}(n) = d^*(n)\mathbf{u}(n) \quad (7)$$

By putting values from (5), (6), (7) in (4) the weight vector is found to be,

$$\begin{aligned} \mathbf{w}(n + 1) &= \mathbf{w}(n) + \mu[\mathbf{p}(n) - \mathbf{R}(n)\mathbf{w}(n)] \\ &= \mathbf{w}(n) + \mu\mathbf{u}(n)[d^*(n) - \mathbf{u}^H(n)\mathbf{w}(n)] \\ &= \mathbf{w}(n) + \mu\mathbf{u}(n)e^*(n) \end{aligned} \quad (8)$$

So the LMS algorithm can be described by the three equations as given below,

$$y(n) = \mathbf{w}^H(n)\mathbf{u}(n) \quad (9)$$

$$e(n) = d(n) - y(n) \quad (10)$$

$$\mathbf{w}(n + 1) = \mathbf{w}(n) + \mu\mathbf{u}(n)e^*(n) \quad (11)$$

The response of LMS algorithm is determined by three principal factors step size parameter, number of weights and eigenvalue of the correlation matrix of input data vector.

#### V. Results

For simulations we have used MATLAB for plotting graphs and have used LMS Type of adaptive Antenna array: Linear

Number of elements: 8

Spacing between algorithm for beam forming, with following parameters:

antenna elements:  $0.5 \lambda$  ( $\lambda$  is wavelength)

Step size,  $\mu$ : 0.001

Weight Error Threshold: -40 dB

We have considered no noise condition. For simulations we have used array factor of linear antenna, to plot radiation pattern. We have considered three different cases with different directions of ‘Signal of Interest’ (SOI) and ‘Signal Not of Interest’ (SNOI). The corresponding results are given below.

*Case 1:* Here, we have assumed that initially, user is at 30 degrees, and there is no interferer. The corresponding radiation pattern is shown in figure 6(a). The resultant Magnitude and phase distribution of antenna elements is shown in figure 6(b) and 6(c) respectively. Figure 6(d) shows the weight error i.e. difference between desired weight and actual weight in dB,

with iterations. As shown by diagram the weight error reduces as iterations are increased.

and 7(c) respectively. Figure 7(d) shows the weight error i.e. difference between desired weight and actual weight.

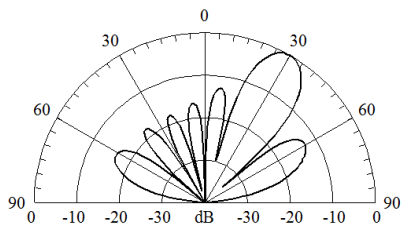

Figure 6(a): Radiation Pattern

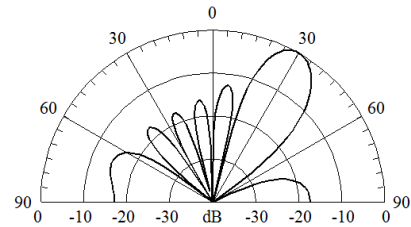

Figure 7(a): Radiation Pattern

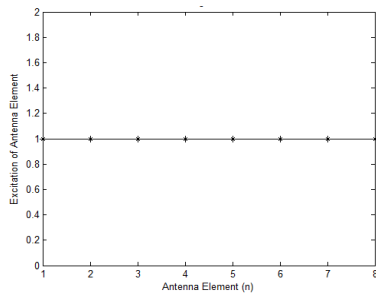

Figure 6(b): Magnitude Distribution

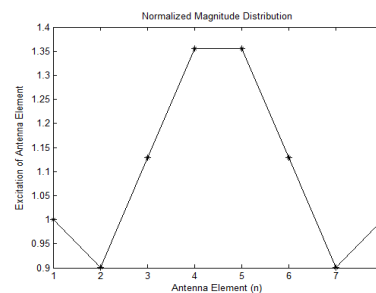

Figure 7(b): Magnitude Distribution

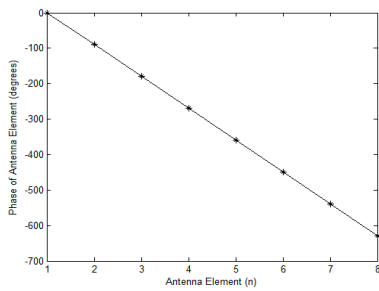

Figure 6(c): Phase Distribution

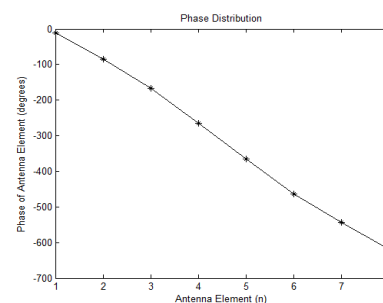

Figure 7(c): Phase Distribution

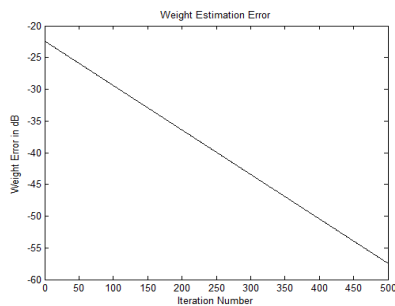

Figure 6(d): Weight error

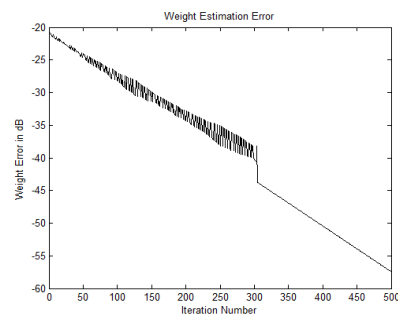

Figure 7(d): Weight Error

*Case 2:* In this case we, have assumed that the user is at same position i.e. 30 degrees, and an interferer arrives at 60 degrees. Now in order to enhance the capacity, the antenna system places a null in the direction of interferer as shown by Radiation pattern in figure 7(a). The resultant Magnitude and phase distribution of antenna elements is shown in figure 7(b)

*Case 3:* Now suppose that another Interferer enters into the environment with direction -60 degrees, so that total number of interferers becomes 2. Now in order to enhance the capacity, the antenna system places another null in the direction of the second interferer as shown by Radiation

pattern in figure 8(a). The resultant Magnitude and phase distribution of antenna elements is shown in figure 8(b) and 8(c) respectively. Figure 8(d) shows the weight error.

becomes more and more complicated to enhance the capacity of the system.

## Conclusion

As we see in the paper that by using adaptive filter algorithm LMS for beamforming, the capacity of the system can be enhanced in a very simple and in an effective manner. More sophisticated algorithms may further enhance performance, but they are more complex in implementation as compared with LMS algorithm.

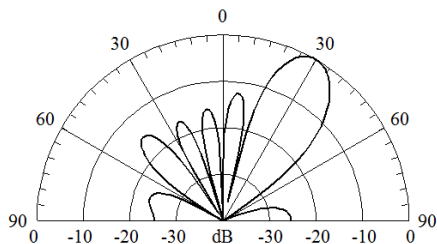

Figure 8(a): Radiation Pattern

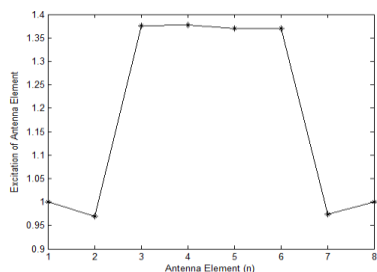

Figure 8(b): Magnitude Distribution

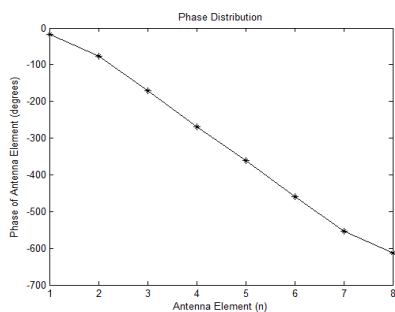

Figure 8(c): Phase Distribution

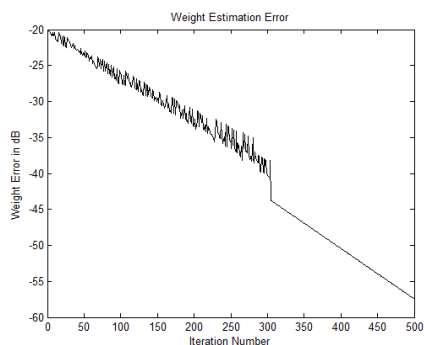

Figure 8(d): Weight Error

It is clear from the figures that as the number of interferers increase the weight error increases and the radiation pattern

## References

- [1] John G. Proakis and Dimitris G. Manolakis, "Digital Signal Processing," fourth edition, Pearson publications, 2007
- [2] J. Gerardo Avalos, Juan C. Sanchez and Jose Velazquez "Applications of Adaptive Filtering," National Polytechnic Institute, Mexico
- [3] Sarosh K. Dastoor, Niteen B. Patel "Adaptive Antenna System: Design and Applications for the Next Generation Mobile Devices," International Journal of Engineering and Innovative Technology (IJEIT) Volume 1, Issue 2, February 2012
- [4] Rana Liaqat Ali, Anum Ali, Anis-ur-Rehman, Shahid A. Khan and Shahzad A. Malik "Adaptive Beamforming Algorithms for Anti-Jamming," International Journal of Signal Processing, Image Processing and Pattern Recognition Vol. 4, No. 1, March 2011
- [5] Shankar Ram "A study of Adaptive Beamforming techniques using smart antenna for mobile communication," Department of Electrical Engineering, National Institute of Technology, Rourkela 2007
- [6] Bhavishya Ramineni, G. Chaitanya Sagar, K. Abhishek Jain, M. Siva Ganga Prasad, T. V. Ramakrishna, K. Sarat Kumar "Comparison and performance evaluation of different adaptive beam forming algorithms in wireless communications with smart antenna," International Journal of Engineering Research and Applications (IJERA), May-Jun 2012
- [7] E. Anji Naik & CH. Bala Swamy "Efficient Adaptive Beam Steering Using INLMS Algorithm for Smart Antenna," ECE Department, QIS College of Engineering and Technology, Ongole, India
- [8] Anurag Shivam Prasad, Sandeep Vasudevan, Selvalakshmi R, Sree Ram K, Subhashini G, Sujitha S, Sabarish Narayanan B "Analysis of Adaptive Algorithms for Digital Beamforming in Smart Antennas," IEEE-International Conference on Recent Trends in Information Technology, ICRTIT 2011, MIT, Anna University, Chennai. June 3-5, 2011
- [9] J. M. Samhan, R. M. Shubair, and M. A. Al-Qutayri, "Design and Implementation of an Adaptive Smart Antenna System," IEEE communication Letters, 2006
- [10] RK Jain, Sumit Katiyar and NK Agrawal "Smart Antenna for Cellular Mobile Communication," VSRD International Journal of Electrical, Electronics and communication engineering, Vol. 1, 2011
- [11] S K Intiaj, Iti Saha Misra "Performance Comparison of Different Adaptive Beamforming Algorithm in Smart Antennas" 5<sup>th</sup> international conference on computer and devices for communication, 2012