

Impact of Sampling Theorem on Pilot Aided Channel Estimation for OFDM based Multi-Carrier System

Richa Bhatt

Electronics & Communication Department
SV National Institute of Technology
Surat, India

Prof. Shweta Shah

Electronics & Communication Department
SV National Institute of Technology
Surat, India

Abstract— Wireless multimedia has created boom in today's era. It is just a fraction of seconds to get information at any time anywhere. All these because of the development of multicarrier communication system, OFDM, which provides high data rate as well as high speed. With that channel estimation becomes more challenging. In such multicarrier systems the time varying channel is often estimated based on different algorithms. These algorithms are basically categorised as blind and non-blind channel estimation techniques. Due to the limitations of blind algorithms such as requirement of the statistical knowledge of received signal, the non-blind i.e. pilot aided channel estimation have become more popular. In such techniques known symbols to the receiver called pilots are inserted in the OFDM data symbols and they should be close enough to fulfil the Nyquist sampling theorem for pilot spacing [1]. This paper shows the simulation results to prove the sampling theorem based on the channel estimation in the multipath fading scenario.

Keywords— Channel Estimation, LS (Least Square), MMSE (Minimum Mean Square Error), Nyquist Sampling Theorem, OFDM (Orthogonal Frequency Division Multiplexing).

I. INTRODUCTION

Multi-carrier modulation has emerged as an effective transmission technique for highly dispersive channels, and has been successfully implemented in a wide variety of digital communication systems. Also single carrier systems suffer from the frequency selectivity of the wideband channel. To overcome the frequency selectivity of the wideband channel, multi-carriers can be used for high rate data transmission. OFDM (Orthogonal Frequency Division Multiplexing) in particular is a special case of multi-carrier modulation transmission. OFDM divides the entire spectrum into parallel sub-channels by dividing the transmit data bit-stream into low bit rate data streams. As bit-rate is lower, OFDM sub-channels have relatively longer symbol duration than existing single carrier systems, which makes it very immune to fast channel fading and intersymbol interference. OFDM has been adopted in several wireless standards such as Digital Audio Broadcasting (DAB), Digital Video Broadcasting Terrestrial (DVB-T), the Wireless Local Area Network (WLAN) Standard; IEEE 802.11a, and the Metropolitan Area Network (W-MAN) Standard; IEEE 802.16a[2].

Channel estimation is an integral part of the OFDM systems and it is one of the most challenging tasks in wireless systems. Channel estimation techniques for OFDM based systems can be categorised in two ways: blind and non-blind channel estimation techniques. The blind channel estimation techniques are based on the statistical behaviour of the received signal without resorting to the additional overhead such as preamble or pilot signals. Obviously such a technique has an advantage of not acquiring an overhead with training signals. But it often needs a large number of received symbols to extract statistical properties and therefore they suffer severe performance degradation in fast fading channels. The non-blind channel estimation techniques use information of the previous channel estimates or some portion of the transmitted signal for the channel estimation. The non-blind channel estimation techniques can be grouped into two categories: data aided and Decision Directed Channel Estimation (DDCE).

In data aided channel estimation, a training sequence which is known to the receiver is transmitted as a complete OFDM symbol or a portion of a symbol so that the receiver can easily estimate the radio channel by demodulating the received samples. This known data sequence is often the frequency domain pilots. There are two types of pilot arrangements: block type and comb type, which are illustrated in fig. 2 and 3 [3]. In block type pilot arrangement, channel estimation is performed by assigning pilot tones to all the sub-carriers of a particular OFDM symbol. This type of pilot arrangement is considered for slow fading channel and for burst type data transmission schemes, where the channel is assumed to be constant over the burst. In the comb type pilot arrangement, channel estimation is performed by inserting pilot tones regularly within OFDM symbols with respect to the time variation of the channel. This type of pilot arrangement is considered for the fast fading channels and when the channel varies between the consecutive OFDM symbols. On the other hand, in the DDCE methods, to estimate the channel corresponding to current OFDM symbol, the channel estimates for the previous OFDM symbol are used. As an outdated channel estimates are used in decoding process, these estimates are less reliable as the channel can vary drastically from symbol to symbol [1].

In this paper pilot aided channel estimation, pilot allocation and impact of variation in pilot spacing are addressed. MMSE (Minimum Mean Square Error) channel estimation technique is considered because of its accuracy at the cost of high complexity. Section II describes the system model for simulation in which pilot insertion and their allocation block is discussed. Section III shows simulation results and finally section IV includes conclusion.

II. SYSTEM DESCRIPTION AND PILOT ALLOCATION

Fig. 1 shows the baseband OFDM system with pilot insertion block highlighted.

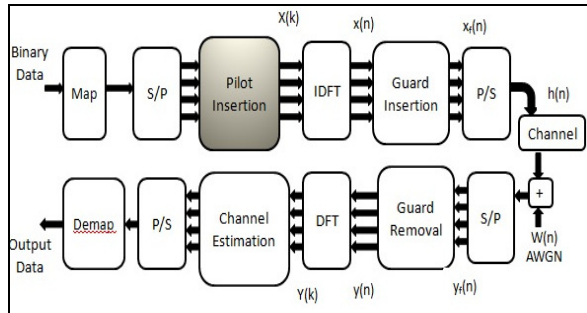

Figure 1. Baseband OFDM System

The first block is mapping block in which the binary information is first grouped and mapped according to the modulation scheme used. Then serial to parallel conversion is made. After serial to parallel conversion pilots are inserted according to two basic pilot arrangement schemes as described in fig. 2 and 3.

A. Pilot Spacing and Allocation

Pilot spacing is the critical issue in pilot aided channel estimation. Hence pilot spacing needs to be determined carefully.

1) *Pilot Spacing in Frequency Domain:* The spacing of pilot tones in frequency domain depends on the coherence frequency of the radio channel, which is related to the Delay Spread [1]. Fig.2 shows the comb-type pilot spacing in frequency domain.

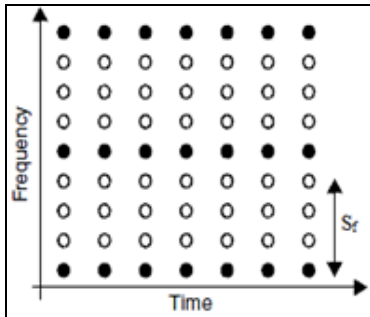

Figure 2. Comb type Pilot Spacing in Frequency Domain [3]

Let S_f be the period of pilot tones in frequency domain. In order to keep track of the frequency-selective channel characteristics, the pilot symbols must be placed at least coherent bandwidth apart. As the coherence bandwidth is determined by an inverse of the maximum delay spread σ_{max} , the pilot symbol period must satisfy the following inequality [4]:

$$S_f \leq \frac{1}{\sigma_{max}} \quad (1)$$

2) *Pilot Spacing in Time Domain:* When the channel is varying across OFDM symbols, in order to be able to track the variation of channel in time domain, the pilot tones need to be inserted at some ratio that is function of coherence time, which is related to Doppler Spread [1]. Fig.3 shows the block-type pilot spacing in time domain.

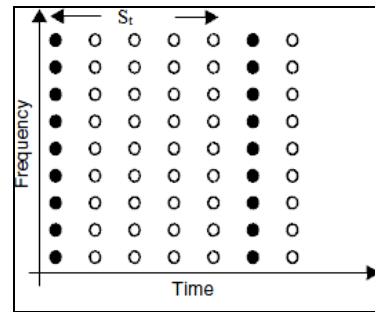

Figure 3. Block type Pilot Spacing in Time Domain [3]

Let S_t denote the period of the period of pilot symbols in time. In order to keep track of the time-varying channel characteristics, the pilot symbols must be placed at least the coherence time apart. As the coherence time is given in an inverse form of the Doppler frequency $f_{Doppler}$ in the channel, the pilot symbol period must satisfy the following inequality [4]:

$$S_t \leq \frac{1}{f_{Doppler}} \quad (2)$$

The rate of insertion of pilots in frequency domain and from one OFDM symbol to another cannot be set arbitrarily because as the channel might be varying both in time and frequency domains. For the reconstruction of the channel, the spacing of the pilots should be according to above equations.

Many research work has been carried out to get the optimum pilot locations in 2-D i.e., time-frequency grid with minimum number of pilots that can sample the channel at least at Nyquist rate. This optimality is in general based on the MSE of the LS estimates [5, 6]. An optimum pilot location is a trade-off between wasted energy in unnecessary pilot symbols,

the fading process not being sampled sufficiently, the channel estimation accuracy and the spectral efficiency of the system.

In addition to minimizing MSE of the channel estimates, the pilots need to simplify the channel estimation algorithms so that resources are not wasted. For example use of constant modulus pilots simplify the channel estimation algorithms as matrix operations become less complex [7] and distribution of more power at pilot tones compared to data symbols [8] improves channel estimation accuracy but this reduces the SNR over the data transmission. Also studies shows that based on the MSE of the LS estimates pilots should be equipowered.

The pattern of pilots is another issue related to pilot arrangement. The selection of a pilot pattern both in time and frequency domain may affect the channel estimation performance, and hence the BER performance of the system. Close insight into equation (1) shows that the number of pilots in frequency domain can at least be taken as the CIR (Channel Impulse Response) length. Moreover, when the MSE of the time domain LS estimation is analyzed, it is observed that the minimum MSE is obtained when the pilots are equispaced with maximum distance. Hence, from MSE of the LS estimation, the pilots in frequency domain need to be equipowered, equispaced, and their number should not be less than the CIR length.

As far as pilot allocation for subsequent OFDM symbol is concerned, either the set of subcarriers chosen in a previous OFDM symbol or a different set of pilots can be used. The use of same subcarriers as pilots is a widely used pilot arrangement. The study of MSE of time domain LS estimation over several OFDM symbol indicates that for a lower MSE, the pilot should be cyclically shifted for the next OFDM symbol. This pilot allocation is similar to those used in DTV applications. As different subcarriers are utilized for each OFDM symbol, the possibility of sticking into terribly fading subcarriers is eliminated.

It is evident from the above discussion for a pilot allocation that a better system performance can be obtained when the system is adaptive. In this case, the information about the channel statistics becomes very crucial. The pilot allocation in the frequency domain needs the delay spread estimation and in the time domain needs Doppler spread estimation. If this information is not available, then the pilot scheme can be designed based on the worst channel condition, that is, maximum expected delay and Doppler spreads [1].

B. System Model :

After inserting pilots either to all sub-carriers with a specific period or uniformly between the information data sequence, IDFT block is used to transform the data sequence $X(k)$ of length N into time domain signal $x(n)$ with the following equation:

$$x(n) = IDFT\{X(k)\} = \sum_{k=0}^{N-1} X(k)e^{j(2\pi kn/N)} \quad (3)$$

Where,
 $n = 0, 1, 2, \dots, N-1$ and N is DFT length

Following the IDFT block is a guard time insertion block. Here guard time which is chosen to be larger than the expected delay spread, is inserted to prevent inter-symbol interference. This guard time includes the cyclically extended part of OFDM symbol in order to eliminate inter-carrier interference (ICI). The resultant OFDM symbol is given as follows:

$$\begin{aligned} x_f &= x(N+n) \quad n = -N_g, -N_g+1, \dots, -1 \\ &= x(n) \quad n = 0, 1, \dots, N-1 \end{aligned} \quad (4)$$

Where,
 N_g = Length of the guard interval

The transmitted signal $x_f(n)$ will pass through the frequency selective time varying fading channel with additive noise. The received signal is given by:

$$y_f(n) = x_f(n) \otimes h(n) + w(n) \quad (5)$$

Where,
 $w(n)$ = Additive White Gaussian Noise (AWGN)
 $h(n)$ = the channel impulse response

At the receiver, after passing to discrete domain through A/D and low pass filter, guard time is removed and $y(n)$ is obtained. Then $y(n)$ is sent to the DFT block for following operation:

$$Y(k) = DFT\{y(n)\} = \frac{1}{N} \sum_{n=0}^{N-1} y(n)e^{-j(2\pi kn/N)} \quad (6)$$

Where,
 $k=0, 1, 2, \dots, N-1$

Assuming there is no ISI, the relation of the resulting $Y(k)$ to $H(k)$, where $H(k)=DFT\{h(n)\}$, $I(k)$ that is ICI because of the Doppler frequency and $W(k)$, where $W(k)=DFT\{w(n)\}$ can be shown by the following equation:

$$Y(k) = X(k)H(k) + I(k) + W(k) \quad (7)$$

Where,
 $k=0, 1, 2, \dots, N-1$

Following DFT block, the pilot signals are extracted and the estimated channel $H_e(k)$ for the data sub-channels is obtained in the channel estimation block. Then the transmitted data is estimated by:

$$X_e = \frac{Y(k)}{H_e(k)} \quad (8)$$

Where,
 $k=0, 1, 2, \dots, N-1$

Then the binary information data is obtained back in "Signal Demapper" block.

Here $H_e(k)$ is the channel estimate based on the channel estimation technique. As MMSE channel estimation is considered for simulation in next section, we will define the MMSE channel estimate as follows [3]:

$$H_{MMSE} = R_{HH} [R_{HH} + \frac{\beta}{SNR} I]^{-1} H_{LS} \quad (9)$$

Where,
 R_{HH} =Autocorrelation matrix of H
 β = A constant depending on the signal constellation
 (For 16 QAM its value is 17/9 [3])
 H_{LS} =The LS estimate of channel

III. SIMULATION RESULTS

In this section impact of pilot spacing on channel estimation process is shown. As discussed before for better channel estimation pilots should be equispaced and their number should be greater than the length of CIR. From the following simulation results we can prove that as number of pilots approaches the length of channel impulse response, the channel estimation performance degrades.

We have considered a typical OFDM system. Here number of pilots is taken in the power of two for the simplicity. A general scenario is considered by considering 256 IFFT size. Cyclic prefix is 1/4 which indicates maximum cyclic prefix length which is used to avoid intersymbol interference (ISI). 4 tap multipath channel gives almost practical scenario assumption. By taking SNR up til 20 dB gives acceptable results which are visible in the figure 4 to 7. Table 1 shows the parameters selected for simulation.

TABLE I. SIMULATION PARAMETERS

No.	System Parameters	
1	Number of IFFT points	256
2	CP length (1/4)	64
3	Modulation Technique	16-QAM
4	SNR	20
5	Multipath channel tap	4
6	Channel estimation technique	MMSE

Fig. 4 to 7 shows the channel estimation performance along with signal constellations with 4 pilots which is equal to the length of the channel impulse response and 8, 16 and 32 pilots which are greater than the length of the channel impulse response respectively.

Fig. 8 describes that how MSE decreases as the number of pilots go beyond the length of the CIR.

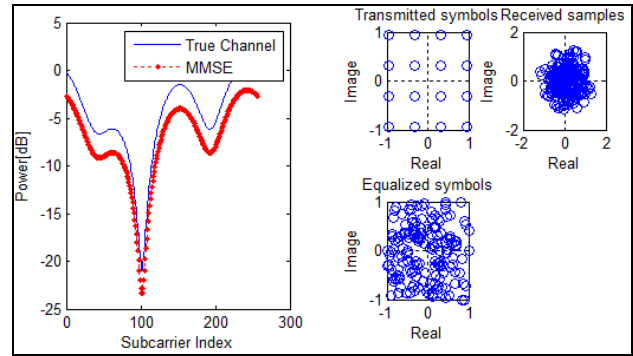

Figure 4. Channel estimation performance and signal constellation for 4 pilots

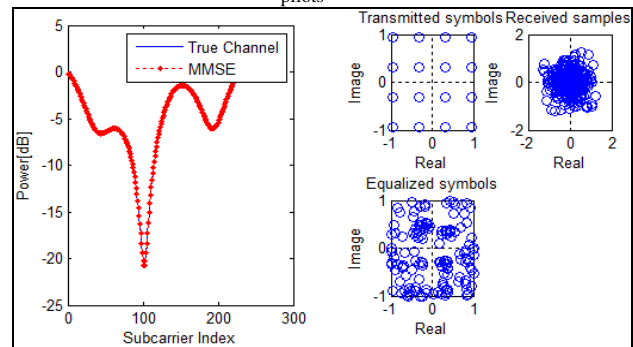

Figure 5. Channel estimation performance and signal constellation for 8 pilots

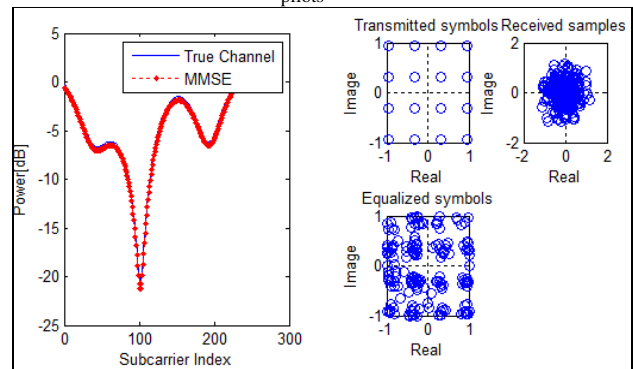

Figure 6. Channel estimation performance and signal constellation for 16 pilots

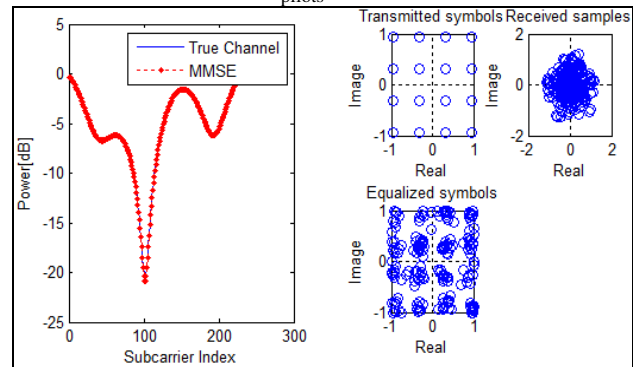

Figure 7. Channel estimation performance and signal constellation for 32 pilots

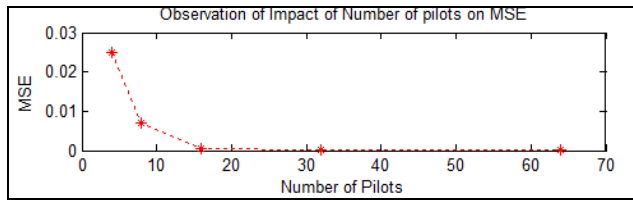

Figure 8. Impact of Number of pilots on MSE of the system

IV. CONCLUSION

In this paper we have observed the impact of sampling theorem in multipath fading channel on the channel estimation performance. From fig. 4 through 7 we can observe that as number of pilots goes beyond the length of channel impulse response, the channel estimation performance improves. Also fig. 8 shows that MSE approaches acceptable level as number of pilots goes up the length of channel impulse response. From fig. 6 and 7 we can see that 16 pilots produce equivalent channel estimation results as 32 pilots but the accuracy of symbol equalization is reduced to some extent. So based on the trade-off between the performance accuracy and the maximum overhead that can be beared by the system any one of the pilot arrangement can be selected. At last we can conclude this discussion as the channel estimation requires pilot symbols which are at least larger than the length of the channel impulse response.

REFERENCES

- [1] Mehmet Kemal Ozdemir and Huseyin Arselan, "Channel Estimation For Wireless OFDM Systems", IEEE Commun. , vol. 9, no. 2, 2nd Quarter 2007.
- [2] Erol Onen, Aydin Akan and Luis F. Chaparro, "Channel Estimation For Wireless OFDM Communication Systems", Proceedings of the 5th WSEAS International Conference on Signal Processing, Istanbul, Turkey, pp. 222-227, May 27-29, 2006.
- [3] Yushi Shen and Ed Martinez, "Channel Estimation in OFDM Systems", Freescale Semiconductor, Application Note, Rev. 1/2006, AN3059
- [4] Yong Soo Cho, Jackwon Kim, Won Young Yang and Chung-Gu Kang, "MIMO-OFDM Wireless Communications with MATLAB", IEEE Press, Jhon Wiley & Sons (Asia) Pte. Ltd., 2010.
- [5] I. Barhumi, G. Leus, and M. Moonen, "Optimal Training Design For Mimo-Ofdm Systems in Mobile Wireless Channels," IEEE Trans. Signal Processing, vol. 51, no. 6, June 2003, pp. 1615–24.
- [6] Q. Sun *et al.*, "Estimation of Continuous Flat Fading MIMO Channels," IEEE Trans. Wireless Commun., vol. 1, no. 4, Oct. 2002, pp. 549–53.
- [7] Y. Li, "Optimum Training Sequences for OFDM Systems with Multiple Transmit Antennas," Proc. IEEE Globecom Conf., vol. 3, San Francisco, CA, Nov. 2000, pp. 1478–82.
- [8] A. Dowler, A. Doufexi, and A. Nix, "Performance Evaluation of Channel Estimation Techniques for a Mobile Fourth Generation Wide Area OFDM System," Proc. IEEE Vehic. Tech. Conf., vol. 4, Vancouver, Canada, Sept. 2002, pp. 2036–40.