

An Analysis of Subfield Based on Fuzzy for Deterministic Indoor Localization in WSN

Güngör YILDIRIM

Yetkin TATAR

Abstract—In many wireless applications, location awareness is of paramount importance and, therefore, there are many algorithms regarding localization problems in literature. Fingerprint-based algorithms are one of them, consisting of two phases; mapping and location estimation. In location estimation phases of some technics based on fingerprint, subfields are used for the purpose of filtering data. A subfield analysis could be complex in applications having big radio maps. In addition to this, unstable RSSI values could make the analysis more difficult. In such a state, different approaches can be used to increase the efficiency. In this paper, an alternative deterministic localization technique suggested by the authors of this paper in an earlier study was explained and then unlike the earlier study, a subfield analysis based on fuzzy was applied with the aim of examining a soft computing approach in localization. The results of the experiments were compared with the results of classical deterministic and probabilistic methods, and the validation of the proposed system was tested.

Keywords— WSN, RSSI, K-Means, KNN, Fuzzy

I. Introduction

Today wireless sensor networks (WSNs) have an important place in wireless communication technologies. It is possible to see many different application fields employing WSNs, from security to healthcare. The technology has various research areas. One of the areas is indoor localization problems in which GPS is ineffective. There are many methods and techniques about the indoor localization in literature [2-4]. Methods based on fingerprint are the most effective ones among them. These methods are based on Received Signal Strength Indicator (RSSI) and use a special database called “radio map” [2,8]. The methods consist of two phases, offline phase and online phase. A radio map (RM) is created by sample data received from multi anchor nodes in the offline phase. In the online phase, the position of a mobile node is guessed with the help of the radio map. There are two important positioning methods often used in online phase, “deterministic methods” and “probabilistic methods” [2,3,8].

In a different study [1], which was carried out by the authors of this paper, alternative approaches were introduced for both the offline and the online phases.

Güngör YILDIRIM
Firat University, Engineering Faculty, Computer Engineering Dept.
Elazig, Turkey

Yetkin TATAR
Firat University, Engineering Faculty, Computer Engineering Dept.
Elazig, Turkey

The first approach is a K-Means-based clustering technique to reduce the radio map to be used. With this, a smaller radio map that can comprehensively represent the closed environment could be built. In addition, logical subfields were created for the purpose of quicker and more flexible determination process. The second is a dynamic deterministic method using a straight logical subfield analysis. Unlike KNN-based methods; in this technique the number of the decision cells is changeable according to logical subfields and the reduced radio map.

As it is understood, the subfield analysis has an important place in the earlier study. Therefore the analysis process has to run quickly and flexibly. However, subsequent experiences have shown that the straight logical analysis could be impractical and complex for system designers in application having big RM. To that end, unlike the study [1], the subfield analysis was tested with a fuzzy classifier in this paper. The aim of preferring fuzzy classifier is because of unstable RSSI behaviors. As is known, RSSI values are affected by many parameters, such as environmental conditions, node position and so on. Therefore the fuzzy is preferred in the phase of the subfield analysis because of its flexibility. Finally the all detections in the earlier study could be done successfully by the fuzzy classifier. The test results were compared with the results of both the KNN-based deterministic approach and the Gaussian based probabilistic approach. In the end, it was observed that the proposed technique was successful as compared to the other approaches.

The remainder of this paper is organized as follows: Section 2 is the related works. In section 3 we describe the design of the system and explains the construction of the radio map. In addition, we describe the clustering of RSSI data by K-Means method and the formation of the subfields to be used. Section 4 discusses classical deterministic and probabilistic methods in indoor localization approaches in WSNs. Section 5 provides the implementation of the system and presents the results. Finally we conclude in Section 8.

II. Related Work

There are many studies which include subfield approaches and radio map optimizations. In one of them [5], a truncation effect which can cause RSSI distributions is examined. It is stated that some errors could happen both in radio map design and in probabilistic methods like Multivariate Gaussian Inference (MGI) because of the fact that the effect is ignored. Therefore a novel method called Multivariate Truncated Gaussian Inference (MTGI) which takes the effect into account is proposed. It is expressed that MTGI is more

successful than MGI due to the fact that the method reduces the packet dropping ratio. In WLAN systems, subfields are used in the radio map and the subfields are created by K-Means [6]. In the study, a classical localization method based on KNN and the radio map subfields are used for position detection. In another study, a novel technique is proposed for constructing a radio map based on a weighting factor in WLAN systems. In addition to this, the reasons of the RSSI distribution are examined with the help of anechoic chamber tests. [7].

III. The System Design

The construction of the fingerprint based indoor localization system developed, which was also used in [1], is presented shortly in this section. The system includes an offline and an online phase. In a fingerprint based method, one of the most important processes is the creation process of the radio map (RM). This process is carried out in the offline phase. The aim is to collect empirical data (calibration data) from anchor nodes and to achieve meaningful arrangement on the map [Fig 1].

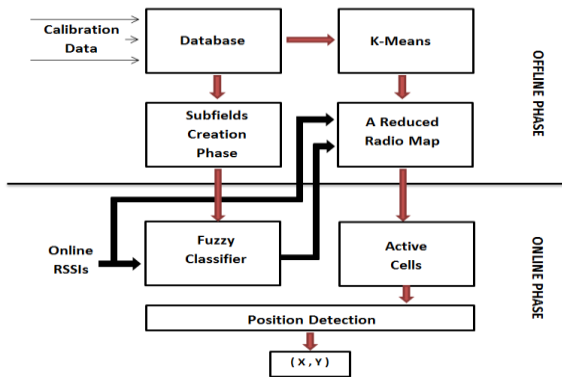

Figure 1. The system design

A closed area of 6x11 mt at each corner of which there is an anchor node was used in the study. The area has 66 cells of 1x1 mt and the cells have 5 RSSI samples for each anchor nodes (A1, A2, A3, and A4). A sample view from some cells for A1 readings is shown in Fig.2. For only one anchor node, an average or dominant value could be used to represent RSSI behavior of a cell. Thus, a cell has a vector of four values.

In the studies, the components preferred are followings: TELOS nodes, a pc using an operating system based on linux kernel, TinyOS 2.1.0 embedded operating system, TOSSIM emulator, nesC and JAVA programming languages.

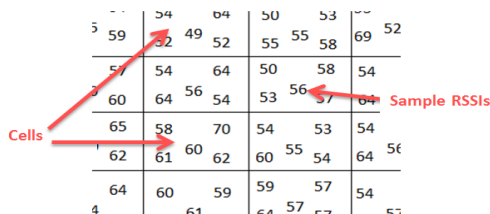

Figure 2. A sample view of the some cells including RSSI readings for anchor 1

The system proposed in [1] consists of three sub processes: the reducing of the radio map, the creation of logical subfields and dynamic detection.

A. The Construction of the Radio Map

The RSSI values achieved from the anchor nodes are generally recorded into the radio map as in Eq.1. In there, R_{ij} is a general form of the information of cell (i,j), $D_{i,j}$ is a RSSI vector and β is optional data (direction etc.) [1-4]. For the purpose of more sensitive RM, in addition to cell readings, linear readings were separately performed for 30° , 45° , 60° and 90° . Thus, 1440 in total samples were collected and this was quite enough for examining the RSSI distribution characteristic in detail [1].

$$R_{i,j} = (D_{i,j}, \beta) \quad (1)$$

The distribution of the RSSI of the RM is shown in Fig. 2. As can be seen in the Fig.2, some values were read a lot and these values could cause erroneous detections, big radio map for big areas and so on. Therefore, one of the aims of [1] was to reduce the RM and this was accomplished by K-Means method.

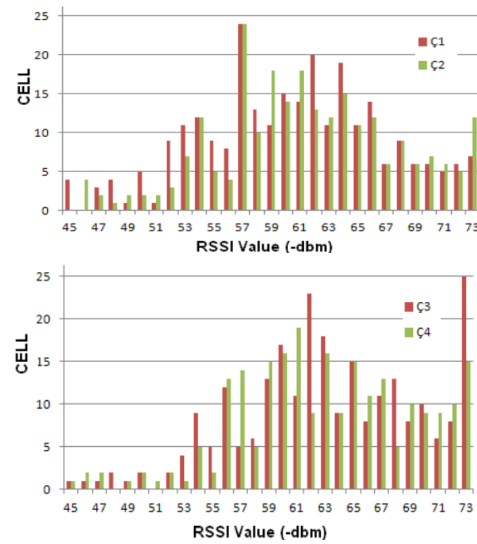

Figure 3. The distribution of the offline crude RSSI values [1]

B. The K-Means Method

Clustering based on K-Means is well-known in literature [7]. The input data for K-Means, $X = \{x_1, x_2, x_3, \dots, x_n\}$, represents the coordinates of the cell having same RSSI value read from the anchor nodes. On the other hand $C = \{c_1, c_2, \dots, c_n\}$ is the cluster coordinates to be calculated according to cluster numbers to be selected. The first step of K-Means is to select cluster number, K, which can change between 1 and 5 according to current RSSI value of anchor node, geographical location and so on. The second step is to calculate new centre of the clusters iteratively. If there is no change at centre of the clusters, the operation is completed. The general vectorial model of K-Means is given in Eq.2 and 3. In the equations,

$\|x_n - c_n\|$ is an euclidian distance between x_n and c_n , k is the cluster number and C_i is the number of the involved cells.

$$\arg \min \sum_{t=1}^k \sum_{j=1}^{C_i} (\|x_j - c_t\|)^2 \quad (2)$$

$$c(x) = \left(\frac{1}{c_i}\right) \sum_{j=1}^{C_i} x_j \quad c(y) = \left(\frac{1}{c_i}\right) \sum_{j=1}^{C_i} y_j \quad (3)$$

Thus, at the end of the clustering process, new RSSI distribution on the RM was obtained as shown in Fig.4.

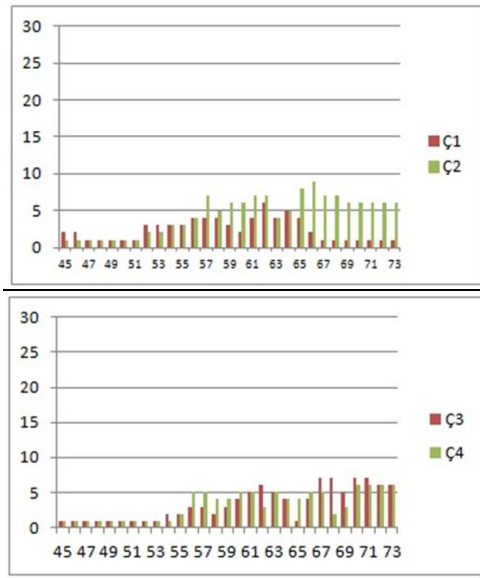

Figure 4. The RSSI distribution of the reduced RM [1]

c. Logical Subfields and Dynamic Detection

In location estimation phases of some techniques based on fingerprint, the subfields have been used for the purpose of filtering data. A subfield analysis could be complex in applications having big radio maps. In addition to this, unstable RSSI values could make the analysis more difficult. In such a case, different approaches can be used. The subfields which aim to filter the RM according to the RSSI readings from the anchor nodes in real time are created by offline calibration values. While the subfields are marked off, empirical observations are used and the system designers could make use of their experiments. In this way, the detection process is able to be done more sensitive. In the earlier study [1], 6 subfields were created by empirical and the analysis of it was carried out by a straight logical approach. Unlike the study [1], in this paper subfield analysis was performed with a fuzzy classifier the membership functions of which are given in Fig. 5 and 6. The raw RSSI distribution in the area were considered in the determination of the membership function of each anchor. For example, according to the anchor1 readings, as the readings up to -50 dBm were evaluated as ‘very close’ areas (within 3-4 mt), the readings between -48 dBm - 56dBm were interpreted as ‘close’ (3.5-5 mt) and so on. The Mamdani method was preferred in the fuzzy classifier.

In the output membership functions, c_1 , c_{1_2} , c_{ort} , $c_{5,6}$ represent the subfields, R_1 , R_{1_2} and R_{mid} , $R_{5,6}$ respectively.

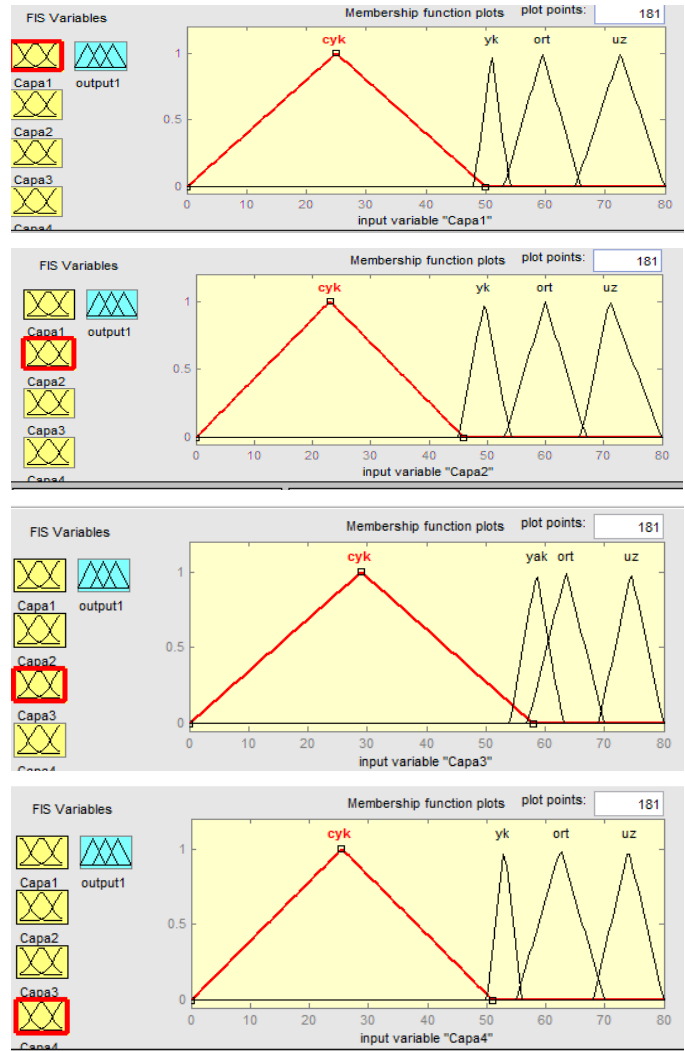

Figure 5. The input and output membership functions for each anchors

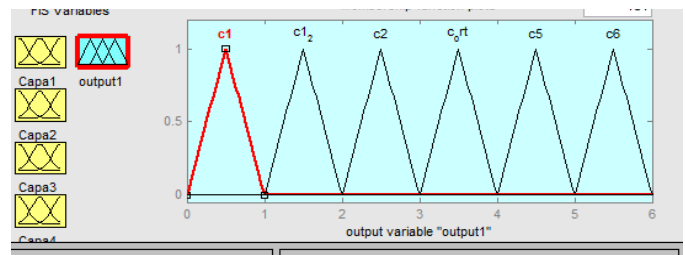

Figure 6. The output membership functions

IV. Other Approaches

A. Deterministic Approaches

The k-NN (K-nearest neighbour) method has been preferred as an estimator in deterministic methods based on fingerprint in wireless technologies. As known, the

deterministic methods depend on the resemblance between the RSSI vector and the calibration data [2]. The k-NN is commonly based on the Euclidean norm (p=2) between online RSSI data. The RM data and k is a user-defined constant. The mathematical model of the k-NN is given in Eq. 4 and 5.

$$\|x\|_p = (\sum_{i=1}^n |x_i|^p)^{1/p} \quad (4)$$

$$L = \frac{1}{K} \sum_{i=1}^K C_i \quad (5)$$

B. Probabilistic Approaches

In probabilistic approaches, the idea is to compute the conditional probability density function of a state x given and this is made according to the Bayes' rule (Eq.6) [2]. In Eq6, p(y|x) is the likelihood, p(x) is the prior and p(y) is a normalizing constant. There are many approaches for computing the likelihood P(y|x). In the study the Gaussian method was preferred as the likelihood approach (Eq.7).

$$P(x|y) = \frac{P(y|x)P(x)}{P(y)} \quad (6)$$

$$P(y|x) = \frac{1}{\sqrt{2\pi\sigma^2}} \exp(-\frac{|x|^2}{\sigma^2}) \quad (7)$$

v. Implementation

An application interface that is prepared for the system was used in [1]. The modelling of the closed area, K-Means analysis, deterministic estimations, probabilistic estimations and the proposed technique were implemented with the help of the interface.

$$MEr = \frac{1}{T} \sum_{i=1}^T \sqrt{(r_x - f_x)^2 + (r_y - f_y)^2} \quad (8)$$

The results of all experiments are demonstrated in Table 1. The mean error value criteria [Eq.8] was used for evaluating the result. As can be seen, the proposed technique became more successful according to the mean error values.

TABLE I. THE RESULTS OF THE EXPERIMENTS

Expm.	RSSI/RSSI2/RSSI3/RSSI4 [1]	Subfield in [1]	Fuzzy Output	Subfield (Fuzzy)	Approach Distance		
					The Proposed Tech.[1] (cm)	Probabilistic (cm)	3-NN [1] (cm)
1	48/60/80/68	R1_2	1.5	R1_2	117,24	22,36	64,382
2	42/73/71/80	R1	0.5	R1	36,00	94,34	21,26
3	52/57/67/68	R1_2	0.5	R1_2	123,00	166,20	93,00
4	54/53/66/64	R1_2	0.48	R1_2	110,65	152,59	116,16
5	70/42/67/66	R2	2.51	R2	91,92	132,09	58,52
6	54/37/80/71	R2	2.5	R2	122,00	58,31	86,00
7	66/47/67/64	R1_2	1.48	R1_2	106,88	156,92	70,40
8	57/53/61/69	R1_2	1.5	R1_2	142,35	205,73	254,65
9	51/59/73/73	R1_2	1.5	R1_2	103,08	158,11	150,96
10	56/53/73/75	R1_2	1.5	R1_2	124,47	250,80	192,08
11	56/60/62/59	R_mid	3.51	R_mid	95,77	362,66	79,64
12	54/60/58/66	R_mid	3.48	R_mid	77,46	94,86	148,38
13	61/65/65/62	R_mid	3.5	R_mid	114,00	273,81	193,77
14	56/55/58/72	R_mid	3.51	R_mid	118,60	127,47	175,50
15	60/66/58/57	R_mid	3.5	R_mid	118,90	272,46	285,50
16	63/59/58/61	R_mid	3.5	R_mid	180,80	215,40	128,00
17	59/62/59/70	R_mid	3.5	R_mid	49,47	65,00	198,64
18	55/57/58/64	R_mid	3.5	R_mid	145,60	290,01	204,00
19	56/57/64/70	R_mid	3.51	R_mid	107,49	163,47	100,44
20	58/65/60/69	R_mid	3.51	R_mid	137,43	358,46	144,39
21	70/58/56/57	R5	4.48	R5	120,00	200,10	35,84
22	67/60/54/58	R5	4.52	R5	119,57	170,66	160,37
23	62/65/54/56	R5	4.5	R5	95,96	239,00	146,49
24	67/70/56/72	R5	4.52	R5	89,05	134,16	187,94
25	64/66/57/60	R5	4.5	R5	132,85	98,23	59,21
26	62/63/50/57	R5	4.5	R5	132,38	137,29	48,83
27	65/59/52/67	R5	4.5	R5	87,32	100,62	81,32
8	62/61/50/57	R5	4.5	R5	170,88	173,56	144,25
29	70/71/55/56	R5	5.5	R5	147,73	248,24	235,35
30	65/61/55/52	R6	5.5	R6	107,93	75,01	205,19
31	63/62/62/46	R6	5.48	R6	85,00	40,00	102,31
32	62/67/54/49	R6	5.51	R6	50,00	111,80	22,36
Mer =					111,31	167,18	131,10

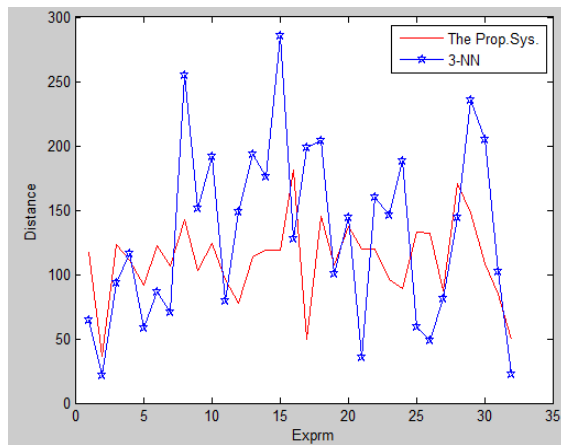

a)

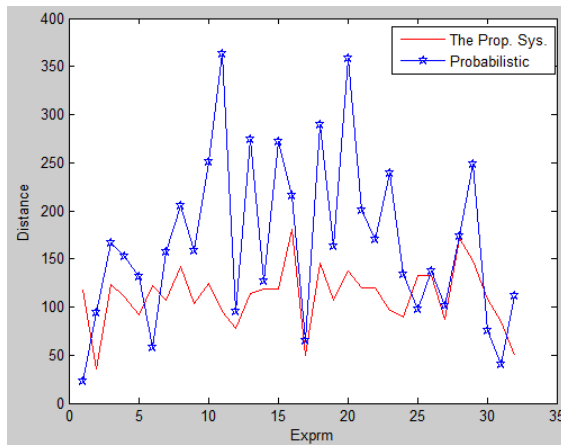

b)

Figure 7. The comparative graphics of the techniques used

As Fig.7.a. shows the comparative graphic of the proposed system - 3NN, Fig.7.b.indicates the comparative graphic of the proposed system – the probabilistic technique.

VI. Conclusions

Subfield approaches have been used in some fingerprint based techniques. The use of the subfields can increase the sensitivity of localization systems. But this process could be complex, especially in applications having a big radio map. Besides, the instability of RSSI values are able to cause erroneous detection. Therefore, in the paper, the subfield analysis based on fuzzy was tested. For this, an earlier study made by the authors of this paper was explained and then, unlike the study, the subfield detection was performed by a fuzzy classifier instead of logical approaches. Thus the sensitive of the system was able to be improved for more complex RMs. The results of the improved technique were compared with the results of other position detection methods based on probabilistic and deterministic. Finally, according to the mean error rate (MEr), the success of the proposed system was shown.

References

- [1] Tatar Y., Yildirim G., “A Dynamic Location Estimation Technique Based on Fingerprint Using a Reduced Radio Map in Wireless Sensor Networks”, Journal of the Faculty of Engineering and Architecture of Gazi University, Vol 29, No 2, 217-226, 2014
- [2] Honkavirta V., Perala T., Ali Loytty S., Piche R., “A Comparative Survey of WLAN Location Fingerprinting Methods”, WPNC’09, pp. 243-251, 2009
- [3] Roos T., Myllymaki P., Tirri H., Misikangas P., Sievanen J., “A Probabilistic Approach to WLAN User Location Estimation”, International Journal of Wireless Information Networks, Vol. 9, No. 3, July 2002
- [4] Deasy T.P., Scanlon W.G., “Simulation or Measurement: The Effect of Radio Map Creation on Indoor WLAN-Based Localization Accuracy”, Wireless Personal Communications, vol. 42, pp. 563-573, 2007
- [5] Chiang Y.H., Chen Y.C., Huang P., “Towards Practical Probabilistic Location Inference for Indoor Environment”, 15th ACM Annual International Conf. on Mobile Comp.and Net. , China, Sep 2009
- [6] Lin MA, Yubin XU, Di WU, “A Novel Two-Step WLAN Indoor Positioning Method”, Journal of Computational Information Systems 6, pp. 4627-4636, 2010
- [7] S.Hur, J.Choi, Y.Park, “Fingerprint Location Database Construction for Enhancing Accuracy of WiFi based Indoor Localization”, in Proc. ISA-IST2012, pp.188-190,2012
- [8] Tatar Y., Yildirim G., “An Alternative Indoor Localization Technique Based on Fingerprint in Wireless Sensor Networks”, International Journal of Advanced Research in Computer and Communication Engineering, Vol. 2, Issue 2, Feb 2013