

Predicting Cutting Force for Flat End Milling Based on Dexels Geometric Model

[S. Abainia and M. Bey]

Abstract— In milling process, and when machining sculptured surfaces cutting forces are variables. Due to the continuous curvature variations of these surfaces abrupt variations in cutting forces are engender. The aim of this research work is to predict the milling forces along tool path during finishing of sculptured surfaces with flat end mills on 3-axis CNC milling machines, using a predictive mechanistic model of cutting forces and a geometric workpiece modeled with Dexels. The main steps of the proposed approach are: 1) approximation of the workpiece by Dexels, 2) milling simulation that consists to simulate the removal material between tools and workpiece by localization the contact regions and 3) cutting forces prediction.

Keywords—Sculptured Surfaces, Dixel, Flat End Mill, Tool Envelope, Tool-workpiece Contact Regions, Mechanistic Forces Model

I. Literature Review

Usually the cutting force affects stability of machining process, chattering vibration, tool deformation, tool wear, machining error and so on. Hence, in view of the great challenge that presents when machining sculptured surfaces for the reason of its continuous variations of the curvature, often cutting forces cannot be well controlled in peaks. From these cutting forces, cutting tool deflection, machine tool chatter, tool wear and breakage can be minimized to enhance tool life. Various approaches to predict the cutting forces in CNC machining have been described in the literature. Among the existant research works in literature related with our own main work aim, where the area of engagement between the workpiece and milling tool using a developed method called composite adaptively sampled distance field “cadf”, where high accuracy in milling simulation was provided [1]. An accurate predictive cutting forces model including some parameters was developed [2]. Mechanistic cutting force model for flat end milling using the instantaneous cutting force coefficients was proposed [3]. From a mechanistic cutting force model an efficient procedure for calibration of the cutting force coefficients for cylindrical end milling was proposed [4]. Including some parameters an improved theoretical cutting force model for peripheral milling was presented [5]. Simulation of the peripheral milling process of thin-walled workpiece for high precision milling was developed [6]. Obtaining a good surface finish of the workpiece is more required, for this, it should be indispensable to select carefully

cutting tools (shape and dimensions), machining strategies and cutting conditions. In this paper, an approach is proposed to predict cutting forces generated during 3-axis finish milling operations using flat end mill tools. Based on geometrical workpiece model in Dexels, the contact regions generated over a common surface between the flat end mill tools and the workpiece are determined for each linear segment of tool path. Through these contact regions the milling forces are applied and should be determined.

II. The Proposed Approach

A. Dixel Model Creation

Dexels are defined as material columns parallel to Z-axis that approximate a solid object. A grid containing the center of each Dixel (X_0, Y_0) is created on (X,Y) plane using steps pas_x , pas_y and raw part dimensions. After this, intersection calculations are done between a vertical line passing by its center and triangles to determine extremums points Z_{min} and Z_{max} (Fig. 1).

B. Milling Process Simulation

In this step, the objective is to simulate the removed material from workpiece using flat end mill tools moving along linear segment of tool path for finishing 3-axis milling operations and for any machining strategy (Parallel Planes, Isoparametric, Z-Constant etc.). For this, it is necessary to model the tool envelope generated by connecting the intermediate discretely tool positions for each linear segment of tool path as depicted in Fig. 2. The reason from this modelling is to achieve accuracy and speed in 3-axis milling simulation rather than created intermediate discrete points for each linear tool path (required more cost time and memory). To simulate the cutting process, a stock allowance is added for all Dexels limited by the raw part. To do this, the generated tool envelope is projected on the (X,Y) plane, where a rectangular region under tool envelope is created which contains all Dexels that have possibility of intersection with the same tool movement envelope. As a result, small Dixel lines from all Dexels are examined only for calculation of the intersection points. During milling operation, intersection points between the Dixel lines parallel to the flat end mill axis and the generated tool envelope along a tool movement are calculated.

S. ABAINIA & M. BEY
Centre de Développement des Technologies Avancées (CDTA)
Algeria

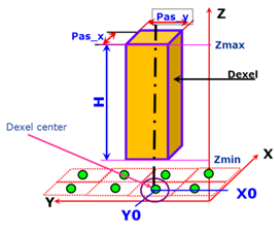

Figure 1. Dixel definition.

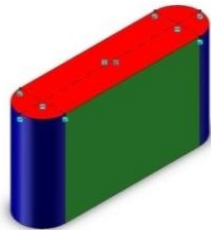

Figure 2. Generated tool envelope.

C. Dixel-Bottom Surface of Tool Envelope Intersection

In this step, the objective is to localize and to determine limits of the projected tool envelope for each linear segment of tool path. From a grid of Dixels center showed on Fig. 3:

- Recuperate the coordinates of initial and final tool position respectively P_i , P_f and tool radius;
- Determine minimum and maximum points respectively (x_{max}, y_{max}) and (x_{min}, y_{min}) of an elementary displacement vector of tool, then after rectangular region is created;
- Determine the coordinates of points A, B, C and C as in Fig. 4.
- Determine the Dixels which belonging effectively to the projected envelope tool (the general case are two circles and rectangle). For this, verify if a Dixel center point (X_{test}, Y_{test}) belongs to the global projected tool envelope.

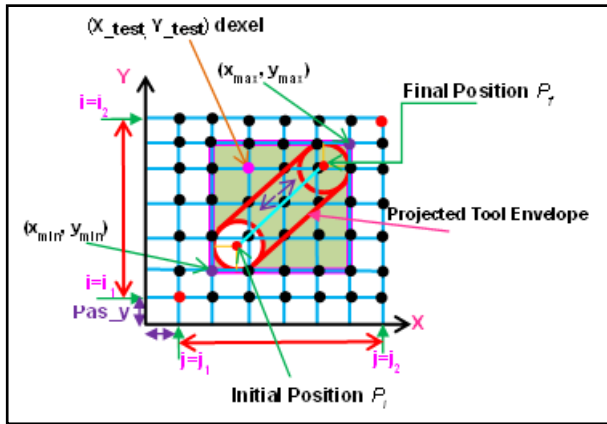

Figure 3. Localization and determination of the Dixels under tool envelope.

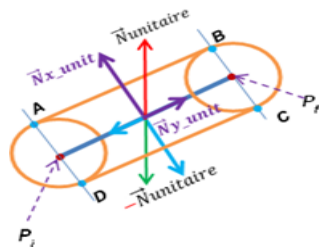

Figure 4. Determination coordinates of points A, B, C and D.

The belonging conditions are:

- Calculate the equation of lines (AB), (BC), (CD) and (DA).

- Calculate the distances between each center Dixel to verify and the lines (AB), (BC), (CD) and (DA).
- Calculate for the same point center Dixel if is belonging to the first or to second circle of the projected tool envelope.
- Once to ensure that the considered points (center Dixels) are included into the projected tool envelope, the determination Z_c coordinate [7] of the intersection points between each Dixel line and bottom surface (generated through a circle sweep) of tool envelope as in following:

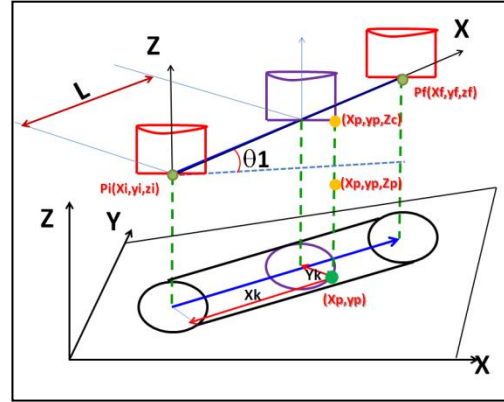

Figure 5. Geometry for calculating intersection points.

Based on Fig. 5 some parameters are determined:

- ★ Calculate the distance (distance_xy) and (distance_xyz) both between two successive tool position initial and final respectively in (X, Y) plane and in (X, Y, Z).
- ★ Calculate the differences delta_x, delta_y and delta_z between each coordinate of P_i and P_f .
- ★ Calculate the distance(x_k) between a point on exterior surface of flat tool and linear tool movement vector both projected into (X, Y) plane given by:

$$x_k = (\text{delta}_x \cdot (x_{\text{test}} - x_i) + \text{delta}_y \cdot (y_{\text{test}} - y_i)) / \text{distance}_{xy} \quad (1)$$

- ★ Calculate the angle of inclination θ_1 between the tool movement direction and the horizontal plane by expression (2).

$$\theta_1 = \text{acos}(\text{distance}_{xy} / \text{distance}_{xyz}) \quad (2)$$

- ★ Calculate the distance (y_k) given as in following:

$$y_k = (\text{delta}_x \cdot y_{\text{test}} - \text{delta}_y \cdot x_{\text{test}} + x_i \cdot y_f - x_f \cdot y_i) / \text{distance}_{xy} \quad (3)$$

- ★ Determine the intersection coordinate z_c :

$$z_c = z_i + ((x_k - \text{sign} \cdot \sqrt{R^2 - y_k^2}) \cdot \text{delta}_z) / \text{distance}_{xy} \quad (4)$$

Two cases to consider according to the term “sign”:

1. If milling up case: $\sin(\theta_1) \geq 0$ then $\text{sign} = 1$.
2. If milling down case: $\sin(\theta_1) < 0$ then $\text{sign} = -1$.

Another particularly case must also be considered is when the tool movement is vertical along the Z-axis, the tool envelope is a circle (the two circles are superposed) and intersection coordinate is set $z_c=z_f$. The validity of z_c coordinate must be included between Z_{min} of Dixel and Z material.

D. Subdivision of the Contact Segment Dixel-Tool Envelope

The removal material is occurred between each Dixel line and bottom surface of the tool envelope. Each contact segment length of Dixel included between Z_{min} and Z_c is divided at a number of points, where their z_c are determined.

E. Projection of the Intersection Points on Tool Surface

The objective is to localize and to determine the intersection points onto tool surface for each tool movement. Each contact segment length and its created points are projected parallel to the tool movement direction on outer surface flat tool according to the first tool position (Fig. 6) by following the steps:

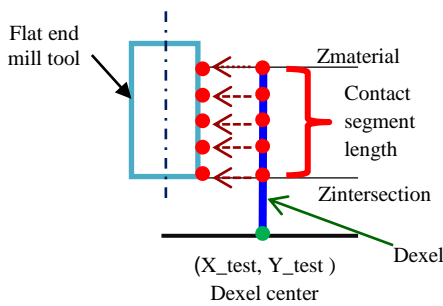

Figure 6. Projected intersection points on flat end tool (horizontal movement).

For each any tool movement:

- ◆ Determine the line equation passes through P_i and P_f .
- ◆ Determine the equation of the circle relative to the initial position $P_i(x_i, y_i)$.
- ◆ From the two equations of line and circle, the intersection projected points of coordinates $(x_{prime}, y_{prime}, z_{prime})$ are calculated.

Fig. 7 presents the removed area by one tool movement.

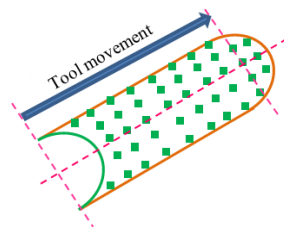

Figure 7. Removed area for one tool movement.

To verify if the intersection projected points are on the front of the first half circle (across from cut) or on the back half of the circle, the scalar product must be calculated. This

latter is between the line (P_iP_f) and vector which passes through P_i and the projected intersection point as in Fig. 8.

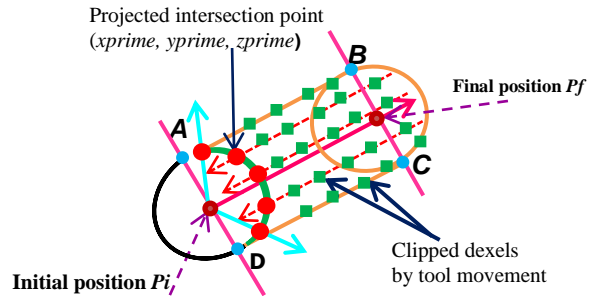

Figure 8. Intersection points projection at initial tool position.

According to the sign of the scalar product two cases is to be regarded:

- ✓ If it is positive this means that the projected points belongs to the front half of the circle (*milling up*).
- ✓ If it is negative this means that the projected points belongs to the back half of the circle (*milling down*).

F. Cutting Tool Segmentation

The effective part of the flat end mill engaged into material is subdivided to a finite number of discs with the same thickness and the same radius R . This subdivision based on Z_{min} and Z_{max} of the intersection points list (Fig. 9). Afterwards, z_{min_disc} and z_{max_disc} are determined for each disc.

G. Affection of the Intersection Points to Discs

The intersection points on flat end tool surface are associated to each created disc based on the Z coordinate of the intersection points and the limits of the disc (z_{min_disc} and z_{max_disc}). Next, for each intersection point the position angle is calculated according to the X -axis (Fig. 10) that is between 0° and 360° .

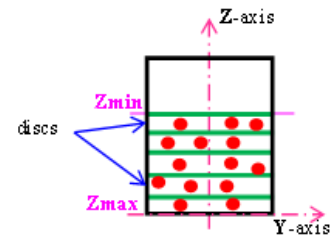

Figure 9. Segmentation of the engagement part.

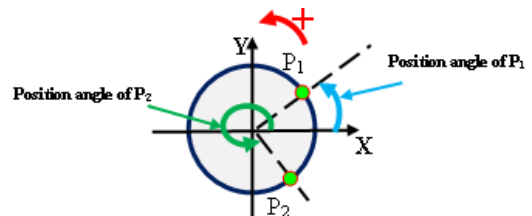

Figure 10. Position angle of points.

H. Creation of the Contact Regions for Each Disc

In this step, the different contact regions for each disc and the entrance angle and the exit angle associated to each region are calculated. To do this, sorting the intersection points based on their positions angles (Fig. 11), then after, affected these intersection points to the contact regions by calculating the difference of the position angles for two consecutive points. Each difference of angles is compared to a predefined angle θ , that helps to create regions for the same disc. Thereafter, the entrance angle (ϕ_{ent}) and the exit angle (ϕ_{exit}) are calculated for each created contact region (Fig. 12).

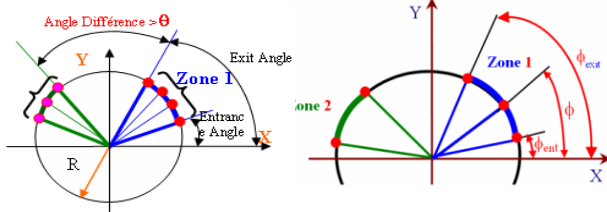

Figure 11. Contact regions for a disc. Figure 12. Point position angle for a disc.

I. Cutting Forces Prediction

The proposed approach used a mechanistic force model to predict the cutting forces for each tool movement along the tool path in three axis machining. For a given point on the flat end mill, the differential components cutting forces (tangential dF_t , radial dF_r and axial dF_a) in a local cartesian system (Fig. 13) linked to the cutting tool corresponding to an infinitesimal element edge length of the cutting tool is given by the following formula [8]:

$$\begin{cases} dF_t = K_{tc} (h_a)^{-p_1} h(\phi, z) dS \\ dF_r = K_{rc} (h_a)^{-p_2} h(\phi, z) dS \\ dF_a = K_{ac} (h_a)^{-p_3} h(\phi, z) dS \end{cases} \quad (5)$$

Where h_a , $h(\phi, z)$ and dS are respectively the average chip thickness, the instantaneous chip thickness and the edge cutting length [9]. K_{tc} , K_{rc} , K_{ac} , p_1 , p_2 and p_3 are constants, depending on edge geometry, tool and workpiece material, determined by experimental tests.

For flat end mill tool $dS=dz$ (thickness of disc) and κ is the positioning angle is the same for all discs given as: $\kappa=90^\circ$.

In local cartesian system (X,Y,Z) the cutting forces for an angular position ϕ are:

$$\begin{bmatrix} dF_x \\ dF_y \\ dF_z \end{bmatrix} = \begin{bmatrix} -\sin \phi & -\cos \phi & 0 \\ -\cos \phi & \sin \phi & -\cos \phi \\ 0 & 0 & -1 \end{bmatrix} \begin{bmatrix} dF_t \\ dF_r \\ dF_a \end{bmatrix} \quad (6)$$

The prediction of the cutting forces acting on flat end mill tools for a tool movement passes by the following steps:
 For each disc, for each contact region and then for each position angle ϕ :

- 1) Calculate the average and the instantaneous chip thickness h_a and $h(\phi, z)$. Then, calculate the differential cutting forces dF_t , dF_r , dF_a and the cutting forces dF_x , dF_y and dF_z .
- 2) Sum all the cutting forces to obtain the cutting force for the considered region.
- 3) Sum all the cutting forces applied on each disc (all regions included).
- 4) Sum all the cutting forces for all discs to obtain the resultant cutting force that applied on the whole flat end mill tool.

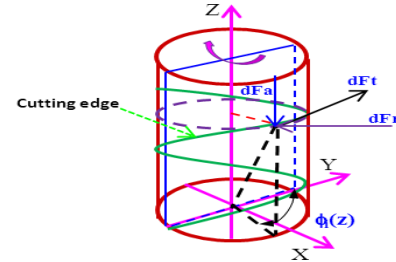

Figure 13. Cutting force components.

III. Results

The proposed approach is performed on an STL model of a part with 172 triangles for convex parabolic surface. The dimensions of the raw part are 137.97mm×50mm×57.19mm. The tool path contains (4429 tool movements) is generated using flat end mill of a radius equal to 5 mm. The machining strategy for tool path generation is parallel plans to X-axis with spaced step=1 mm (Fig. 14).

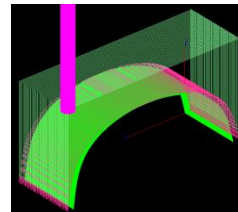

Figure 14. Machining toolpath.

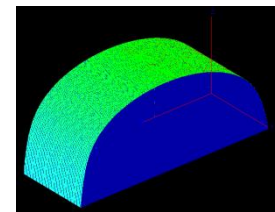

Figure 15. Dixel geometric model.

The geometric model of Dixel is generated using the steps along X and Y axis equal to 0.2 mm for both directions (Fig. 15).

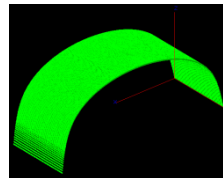

Figure 16. Stock allowance (1mm).

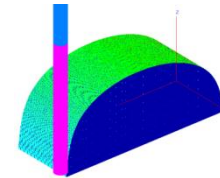

Figure 17. Machining simulation

To remove the material from workpiece a stock allowance (1 mm) is added for each Dixel (Fig. 16) and a flat end mill tool (diameter 10 mm and length 110 mm) is used in milling simulation. At the end of the machining simulation the desired shape and dimensions are obtained (Fig. 17). Taking in consideration the selected parameters of the CNC milling machine (maximum spindle speed = 2000 rpm and maximum available machine feedrate=50000mm/min) and young

modulus of the cutting tool $E=210000 \text{ N/mm}^2$, maximum tool deflection=0.5mm with (04) flute edges having 30° as helix angle. The intersection points produced between flat end mill and tool envelope are localized at an individual tool movement numbered 1396 (Fig. 18). The considered Dexels clipped by this tool envelope are determined as in Fig. 19.

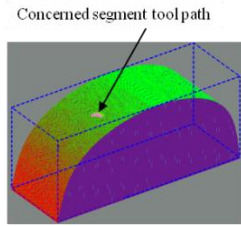

Figure 18. Elementary segment tool path numbered 1396.

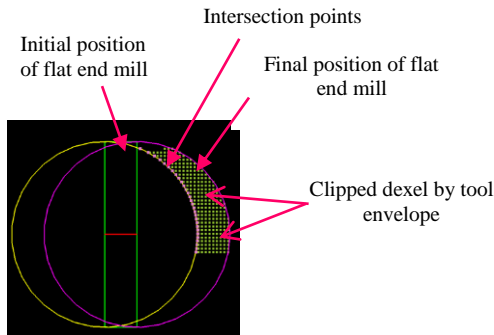

Figure 19. Clipped Dexels for linear segment of tool path.

Afterwards, the contact segment lengths of the clipped Dexels are determined. Then, each of them (contact segment length) is divided in several discrete points spaced with 0.2 mm. The discrete point set on each contact segment length must be projected on front side of flat end mill (up milling case) at initial tool position. In the next step, the flat end mill is segmented according to the axial cutting tool (Z-axis) to (04) elementary discs with thickness equal to 0.2 mm, where the intersection points are affected to each created disc (Fig.20).

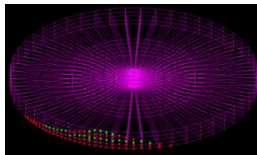

Figure 20. Projected intersection points on front side of flat end mill.

The intersection points and the contact region for the fourth created disc engaged in the material are depicted in Fig. 21.

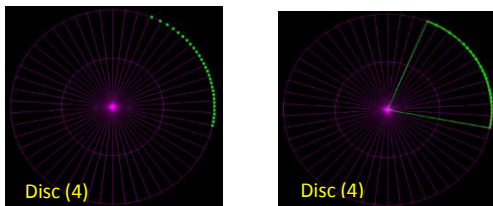

Figure 21. Intersection points and contact region for 4th disc at the bottom.

The coefficients of the mechanistic force model from from experimental tests are given by [8]: $K_{tc}=207 \text{ MPa}$, $K_{rc}=1.39 \text{ MPa}$, $K_{ac}=0$, $p1=0.67$ and $p2=0.043$.

When the contact regions are determined, the cutting force components and its cutting force resultant are calculated. For more clarifying the presentation of graphs some tool movements from 1338 to 1410 were taken. The resultant cutting force F_{result} and its components F_x , F_y and F_z variations corresponding respectively to the tangential, radial and axial force are depicted in Fig. 22. Abrupt variations of the cutting forces are observed.

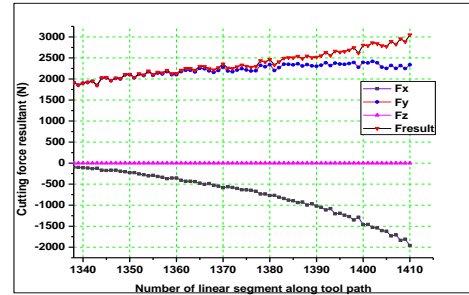

Figure 22. Resultant cutting force and its components variations.

IV. Conclusion

In this paper, an approach for predicting the cutting forces, during sculptured surface finishing on 3-axis CNC milling using flat end mills for each tool movement, is proposed and implemented. This approach integrates Dexels geometric model, milling simulation based on swept tool envelope and mechanistic force model. The results show the influence of the surfaces curvatures variations on the contact region between flat end mills and surfaces and consequently on the cutting forces. Then, to control cutting forces during milling operations and to obtain a smooth milling, feedrate optimization will be subject as future work.

References

- [1] Erdim H and Sullivan A. "High Accuracy Computation of Geometric Properties of Cutter Workpiece Intersection using Distance Fields for NC Milling", *Procedia CIRP* 4, 2012, pp.84-89.
- [2] Jerard RB, Fussell BK, Yalcin C and Erzan Y, "Real time calibration of cutting force models for cnc milling", *Proceedings of 2004 Japan USA Symposium on Flexible Automation (JUSFA)*, Denver, Colorado.
- [3] Wan M, Zhang WH, Tan G and Qin GH, "New Cutting Force Modeling Approach for Flat End Mill", *Chin J Aeronaut* 2007, 20: pp. 282-288.
- [4] Wan M, Zhang WH, Dang J W and Yang Y, "A novel cutting force modelling method for cylindrical end mill", *Appl Math Model* 2010, 34: pp.823-836.
- [5] Liu XW, Cheng K, Webb D and Luo XC, "Prediction of cutting force distribution and its influence on dimensional accuracy in peripheral milling", *Int J Mach Tool Manufact*, 2002, 42: pp.791-800.
- [6] Wan M, Zhang WH, Tan G and Qin GH, "Systematic simulation procedure of peripheral milling process of thin-walled workpiece", *J Mater Process Tech*, 2008,197, pp.122-131.
- [7] Byoung K, Choi and Jerard RB, *Sculptured surface machining*. Publisher Springer US; 1998, pp.251-283.
- [8] Wan M and Zhang WH, "Calculations of chip thickness and cutting forces in flexible end milling", *Int J Adv Technol*, 2005.
- [9] Fussell BK, Jerard RB and Hemmett JG, "Robust Feedrate Selection for 3-Axis NC Machining Using Discrete Models", *J of Manuf Sci and Engineering* , 2001, pp.123-221.