

Parameter identification of Magnetorheological damper using particle swarm optimization

A. Elsawaf, H. Metered, T. Vampola, Z. Šika

Abstract— Particle swarm optimization (PSO) technique has achieved a considerable success in solving nonlinear, non-differentiable, multi-modal optimization problems. Currently, PSO is broadly applied in several scientific and engineering optimization applications. This paper introduces an identification of magnetorheological (MR) damper's parameters using the PSO algorithm to introduce a more simple and accurate model. The proposed model predicts the MR damper force as a nonlinear function of the damper velocity, acceleration and command voltage to the damper coil, without using any complex differential equations, which will be very beneficial for complicated systems. PSO algorithm aims to minimize the root-mean-square-error of the damping force between the proposed model and the modified Bouc-Wen model which can estimate the dynamic behavior of the MR damper precisely. The validation of the proposed model is achieved by comparing its behavior against the behavior of the modified Bouc-Wen model. The validation results clearly reflect that the use of the proposed model can dependably predict the dynamic response of the MR damper as a nonlinear function of damper velocity, acceleration and command voltage.

Keywords—MR damper, modified Bouc-Wen model, PSO, parameter identification

I. Introduction

Magnetorheological (MR) fluids are materials that respond to an applied magnetic field with a change in rheological behavior. A very effective actuator for vibration control can be attained with the MR fluid damper [1]. It has been applied over a wide range of vibration control applications: from automobiles [2, 3] to railway vehicles [4] and civil structures such as buildings [5, 6]. Several mathematical models have been developed for describing the behavior of MR dampers. In fact, some models have been introduced to describe the MR damper force-displacement relation, but they were unable to model its nonlinear force-velocity behavior. Therefore, these models were considered unsuitable for vibration control simulations. More accurate dynamic models were developed and presented in the literature [7-18].

Identification techniques can be generally classified into two categories: parametric and non-parametric techniques.

Parametric models are based on mechanical idealization consisting of an arrangement of springs and viscous dashpots [7-11]. The most appropriate parametric model for the identification of an MR damper is the modified Bouc-Wen (M B-W) model [7]. Through curve fitting of experimental results, 14 parameters for a given damper were determined. For direct dynamic modelling of MR dampers, those parametric models are very useful. For example, prediction of the damper force for given inputs (voltage signal and the time history of the relative displacement across the damper's ends).

Unlike parametric models, nonparametric models do not make any assumptions on the underlying input/output relationship of the system being modelled. Accordingly, a higher amount of input/output data has to be used to recognize the system, enabling the consequent reliable prediction of the system's response to arbitrary inputs within the range of the training data. The main non-parametric identification techniques suggested for MR dampers are interpolating polynomial fitting (Restoring Force Surface method) [12], neural networks [13-17] and neuro-fuzzy modelling [18].

Once a parametric model is selected, the values of system parameters are determined in such a way as to minimize the error between experimental data and the simulation from the model. In [7], for the modified Bouc-Wen model, a least-squares output-error method was employed, combining with a constrained nonlinear optimization, to update the model's 14 parameters required to model the MR damper. The optimization was performed using the sequential quadratic programming algorithm available in MATLAB software. The experimental validation in ref. [7] showed that the modified Bouc-Wen model is able to accurately predict the response of a typical MR damper over a wide range of operating conditions under various input voltage levels.

Numerous investigations of the identification of MR damper have been proposed to improve its model validity and efficiency. The modified Bouc-Wen parameters were determined using a computationally efficient Genetic Algorithm (GA), as done in [19]. Also, Kwok et al. [20] presented a PSO technique for the parameter identification of MR damper, for the first time. The latter approach is used in this paper for parameters identification of the proposed model of the MR damper to capture the behaviour of the modified Bouc-Wen model.

This paper offers a theoretical investigation of the dynamical behavior of MR fluid damper. An efficient and simple model is developed based on the model published first in ref. [21], Weng model, to identify the damping force as a function of the damper velocity, acceleration and input voltage to the magnetic coil, without using any complex mathematical or differential equations, which will be very valuable for large and complicated engineering systems. Further papers [22, 23]

A. Elsawaf and H. Metered
Czech Technical University in Prague and Helwan University
Czech Republic and Egypt

T. Vampola and Z. Šika,
Czech Technical University in Prague
Czech Republic

were published by applying that model in automotive semi-active suspension system. The identification and its validation are done using both simulated data generated using the modified Bouc–Wen model.

The rest of this article is organized as follows: the next section presents the Modified Bouc-Wen model. Section III describes the updated model. The implementation of particle swarm optimization algorithm is presented in section IV. Section V proposes a detailed discussion of the validation results. Finally, conclusion is proposed in last section.

II. The Modified Bouc-Wen Model

The mechanical idealization based on the modified Bouc-Wen model [14] is illustrated in Fig. 1. The phenomenological model is governed by the following equations:

$$\begin{aligned}
 F &= c_1 \dot{y} + k_1(x - x_0) & (1) \\
 \dot{y} &= \{\alpha z + c_0 \dot{x} + k_0(x - y)\} / (c_0 + c_1) & (2) \\
 \dot{z} &= -\gamma |\dot{x} - \dot{y}| |z|^{n-1} z - \beta (\dot{x} - \dot{y}) |z|^n + \delta (\dot{x} - \dot{y}) & (3) \\
 \alpha &= \alpha(u) = \alpha_a + \alpha_b u & (4) \\
 c_1 &= c_1(u) = c_{1a} + c_{1b} u & (5) \\
 c_0 &= c_0(u) = c_{0a} + c_{0b} u & (6) \\
 \dot{u} &= -\eta(u - v) & (7)
 \end{aligned}$$

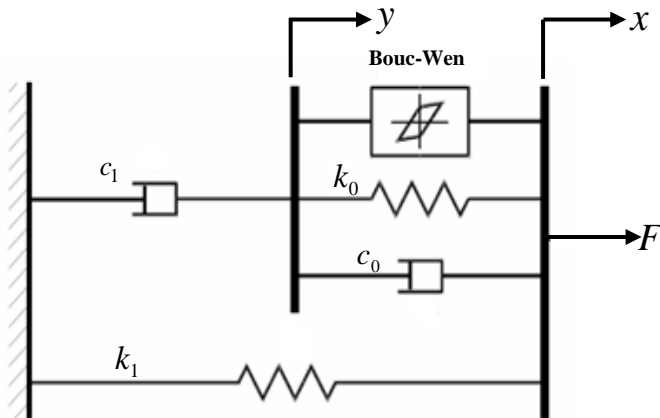

Figure 1. Modified Bouc-Wen Model [7]

TABLE I. TPARAMETERS FOR THE MODEL OF MR FLUID DAMPER [24]

SYMBOL	VALUE	SYMBOL	VALUE
c_{0a}	784 Nsm ⁻¹	α_a	12441 Nm ⁻¹
c_{0b}	1803 NsV ⁻¹ m ⁻¹	α_b	38430 NV ⁻¹ m ⁻¹
k_0	3610 Nm ⁻¹	γ	136320 m ⁻²
c_{1a}	14649 Nsm ⁻¹	β	2059020 m ⁻²
c_{1b}	34622 NsV ⁻¹ m ⁻¹	A	58
k_1	840 Nm ⁻¹	n	2
x_0	0.0245 m	η	190 s ⁻¹

In the above equations, x and F are the displacement and the force generated by the MR fluid damper respectively. y is the “internal displacement” of the MR fluid damper model, it is noted that this is a fictitious variable and does not correspond to an actual physical displacement. z is an evolutionary variable that accounts for the hysteresis effect. The variable u in the first order filter (7) is introduced to account for the effect of the command voltage v sent to the current driver and η is the gain filter. The accumulator stiffness is represented by k_1 ; the viscous damping observed at large and low velocities are represented by c_0 and c_1 , respectively. k_0 is present to control the stiffness at large velocities; x_0 is used to account for the effect of the accumulator. α is the scaling value for the modified Bouc–Wen model. The scale and shape of the hysteresis loop can be adjusted by γ, β, A and n .

A total of 14 model parameters [24], which are given in Table I, were obtained to characterize the MR fluid damper using experimental data and a constrained nonlinear optimization algorithm. The modified Bouc-Wen model is the most common model for studying the dynamic behavior of MR dampers theoretically. It was used for different control applications in various engineering systems to implement the MR damper and study the performance of the system.

III. Updated Model of MR Damper

Firstly, there are four steps to model an MR damper which can be summarized as follows:

The first step is to collect the identification data for the damper force under various inputs, i.e, the damping force owing to the sinusoidal input velocity of various amplitude and frequency, under possible working conditions, such as a constant applied voltage to the damper coil. The second step is to put up a proper mathematical model so as to characterize the hysteretic loop between the sampled damper force and input velocity. The third step is to identify the unknown parameters in model equations using any method that mentioned in the literature. The last step is to validate the model against any reference model behaviour. In this paper, the validation is done using both simulated data generated from the modified Bouc–Wen model [7].

Secondly, this section deals with the development of the model suggested first by Weng et al. [21] as following:

$$F_d = f_0 + C_b \dot{x} + \frac{2}{\pi} f_y \tan^{-1} [k(\dot{x} - \dot{x}_0 \operatorname{sgn} \dot{x})] \quad (8)$$

where,

$$f_y = \frac{f_y}{1 + e^{-1.1(V-2.3)}}, \quad \dot{x}_0 = \frac{c_w}{1 + 1.81e^{-0.2V}}, \quad C_b = \frac{c_b}{1 + \alpha e^{-\beta V}}$$

and f_0 is the offset force of the MR damper, c_b is the slope coefficient of the hysteresis curve f_y and k are two coefficients characterizing the maximal damping force, and c_w is the width coefficient of the hysteresis curve, F_d represents the restoring force of the MR damper.

Equation (8) seems relatively simple to calculate the damping force, but it has two limitations: (A) there is a big difference in the damping force values through the tension and compression strokes as shown in Fig. 2, this notes was documented in Ref. [23]. (B) This equation is valid only in a certain range of the sinusoidal amplitude excitation, $a \leq 15$ mm, and a specified value of excitation frequency, $f = 2$ Hz, [23].

Two terms are multiplied with (8) to adjust the Weng model response. One of them is related to the sinusoidal excitation amplitude to deny the limitation number (A) and the other is related to the excitation frequency to deny the limitation number (B). So, the proposed model can be formulated using the following equation:

$$F_d = f_0 + C_b \dot{x} + \frac{2}{\pi} f_{yl} \tan^{-1}[k(\dot{x} - \dot{x}_0 \operatorname{sgn} \dot{x})] \quad (9)$$

$$\times (w_1 a + w_2) \times (w_3 f + w_4)$$

PSO technique is used to search about the optimum values of (9) to be agreed with the simulated results generated by solving the well-known MR damper model, the modified Bouc–Wen model, published in [7].

IV. PSO Implementation

Particle swarm optimization (PSO) algorithm is a population-based optimization technique originally contributed by Kennedy, Eberhart and Shi [25], [26]. After that many researchers used the PSO algorithm to solve different problems in different fields. Even some researchers worked on modifying the algorithm itself to suite their problems and to get a better behavior convergence [27].

PSO optimizes a specified problem by iteratively trying to enhance a candidate solution regarding a given measure of quality. The members in the population which named as, particles have their own positions and velocities, and fly around the problem space in swarms looking for best fitness value. The movements of the particles are influenced by their local positions and the overall best position obtained from all particles in the solution space. The particles' positions are continuously updated through iteration. This is expected to move the swarm toward the best solutions.

The initial positions and velocities of the particles are generated randomly in the solution space. Through iteration process, each particle updates its position $y_p^{(\tau)}$ and its velocity $v_p^{(\tau)}$ towards the optimum solution as follows [27]:

$$y_p^{(\tau+1)} = y_p^{(\tau)} + v_p^{(\tau+1)}$$

$$v_p^{(\tau+1)} = \chi \times \left(v_p^{(\tau)} + acc_1 \times rand_1 \times [b_p^{(\tau)} - y_p^{(\tau)}] + acc_2 \times rand_2 \times [g^{(\tau)} - y_p^{(\tau)}] \right) \quad (10)$$

where $v_p^{(\tau)}$ is the velocity of the particle p at the generation τ , χ is the constriction coefficient, acc_1 and acc_2 are

acceleration coefficients, $rand_1$ and $rand_2$ are random numbers between 0 and 1, $b_p^{(\tau)}$ is the individual best position and $g^{(\tau)}$ is the global best position selected from all particles.

The main goal of solving the current optimization problem is to find the proposed model parameters to simulate the behavior of the Bouc–Wen model. The fitness function is considered to be the root mean square error (RMSE) between the target force generated using the modified Bouc–Wen model $f_j^{(trgt)}$ and the predicated force using the proposed model $f_j^{(pred)}$.

$$RMSE = \sqrt{\frac{\sum_{j=1}^n (f_j^{(trgt)} - f_j^{(pred)})^2}{n}} \quad (11)$$

The nonlinear optimization problem which determines the proposed model's parameters is defined as:

Find $X = (w_1, w_2, w_3, w_4, c_b, f_y, k, c_w, \alpha, \beta)$
 To minimize $f_{obj}(X) = RMSE$ (12)

The problem has been executed for different number of particles with different number of iterations. The solution is seems to be saturated when the number of particles and number of iterations are 100 and 3000 respectively. The constriction coefficient is taken as $\chi = 0.73$ while, acc_1 and acc_2 are equal to 2.05 [27]. The above mentioned optimization stages are summarized in Fig. 3.

Table II shows a comparison between the old parameters values of (1) reported in Ref. [21] and the proposed parameters values obtained by solving (12).

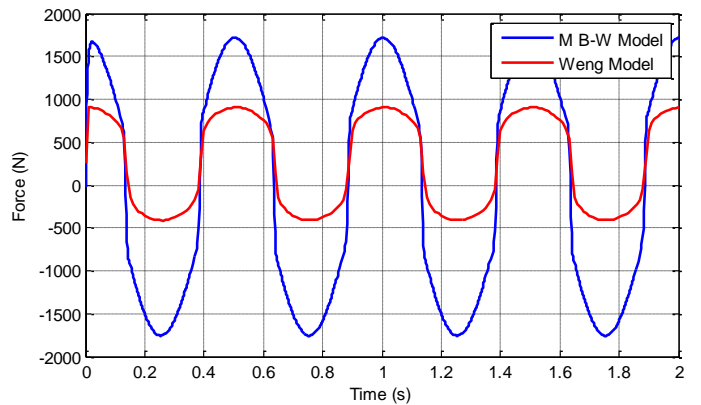

Figure 2. Comparison between modified Bouc-Wen model and Weng model at amplitude of 15 mm, frequency of 2 Hz, and 3 volt

TABLE II. PARAMETERS FOR THE PROPOSED MODEL OF MR DAMPER

SYMBOL	WENG VALUES	PROPOSED VALUES
c_b	1.51	1.7
f_y	720	698.3
k	0.0725	0.08
c_w	40	30
α	10.34	4.55
β	1.04	-2

where $w_1=0.0074$, $w_2=1.75$, $w_3=0.15$, and $w_4=0.92$

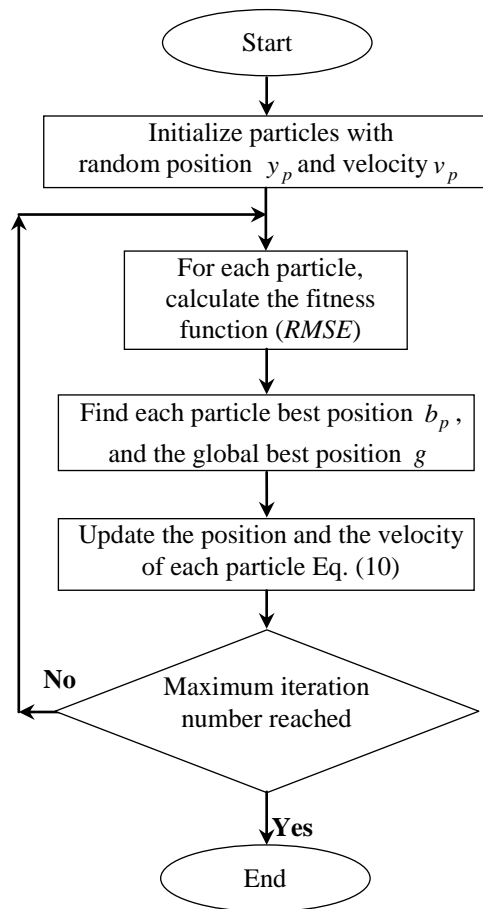

Figure 3. Optimization procedure flow-chart

v. Validation Results

The proposed model is validated against the simulated results of the modified Bouc-Wen (M B-W) model according to the validation data sets of Table III. Fig. 4 shows a comparison between the target force and the predicted force at displacement amplitude and frequency of $a = 16$ mm and $f = 2$ Hz, respectively, with command voltage 1.5 v. Fig. 4 demonstrates a very good agreement between the modified Bouc-Wen model and the proposed one, thus indicating that

the proposed model is able to predict the hysteresis force, as shown in Fig. 4c, of the MR damper accurately and efficiently.

In addition to the graphical verification of the efficiency of the proposed model, a quantitative analysis of the errors for the validation point has been calculated. The normalized errors between the validation results generating by the proposed model and the simulated results using the modified Bouc-Wen model can be efficiently expressed. According to Fig. 4, the root mean square values of the simulated using modified Bouc-Wen and simulated using the proposed model forces are 802.18 and 810.61 respectively. This difference of approximately 1.05 % is acceptable.

Additional validation results are done to show the effectiveness of the proposed model against the simulated results using the modified Bouc-Wen (M B-W) model. Figs. 5-9 introduce a lot of comparisons between the prediction response by the proposed model (red lines) and the simulated using modified Bouc-Wen mode (blue lines) according to the validation sets of Table III; with different excitation amplitude, excitation frequency and input voltage to the damper coil. Each figure consists of three relations; force-time, force-displacement and force-velocity to verify the success of the proposed model. The examination of Figs. 5-9 reveals that a good agreement exists between the simulated results using the proposed model and the simulated results generated by the modified Bouc-Wen. So, in all cases, there is a reasonably good similarity between the behavior of the proposed model and the behavior of the modified Bouc-Wen.

TABLE III. VALIDATION DATA SETS

SYMBOL	VALUE
Amplitude (mm)	[4 8 12 16 20]
Frequency (Hz)	[1 2 3]
Voltage (v)	[0.5 1 1.5 2 2.5 3]

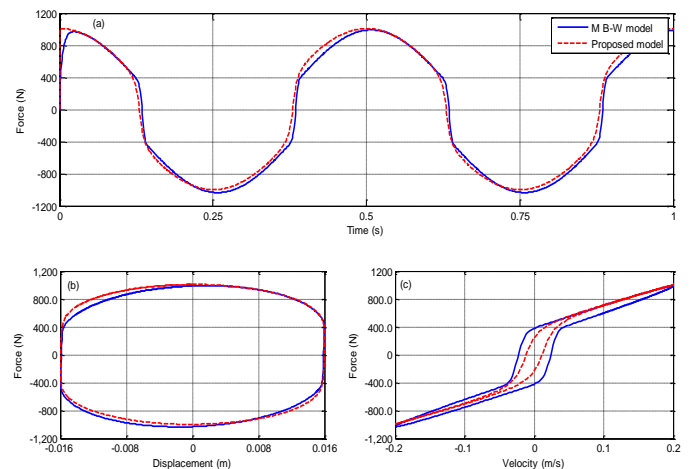

Figure 4. Comparison between the proposed model and modified Bouc-Wen model at $a = 16$ mm, $f = 2$ Hz, $v = 1.5$ volt

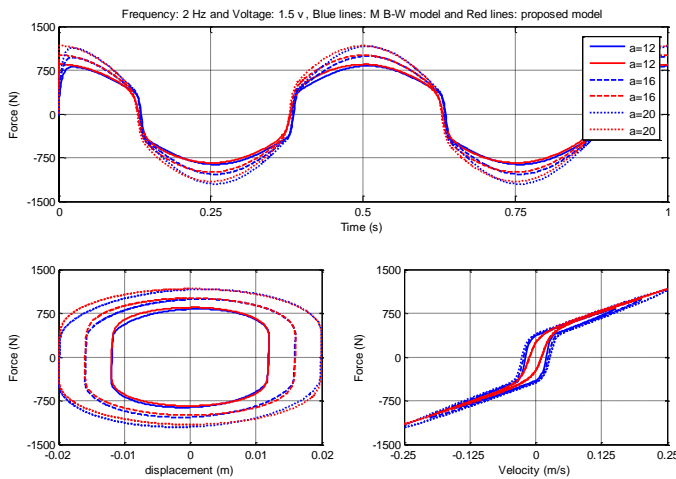

Figure 5. Comparison between the proposed model and modified Bouc-Wen model at $f = 2$ Hz, and $v = 1.5$ v and different amplitude

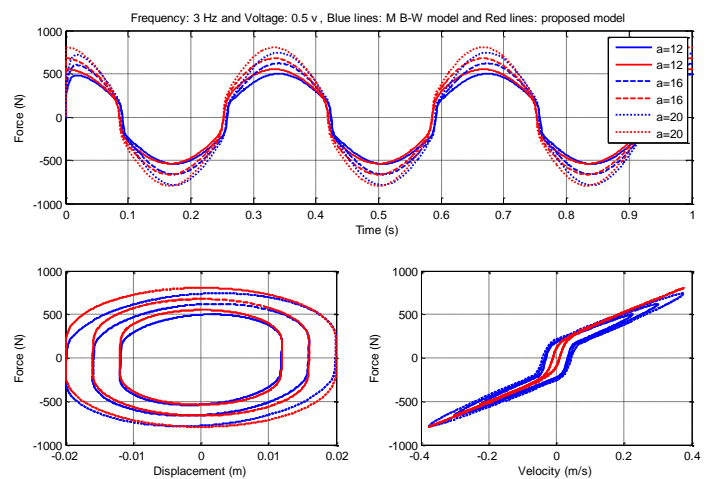

Figure 8. Comparison between the proposed model and modified Bouc-Wen model at $f = 3$ Hz, and $v = 0.5$ v and different amplitude

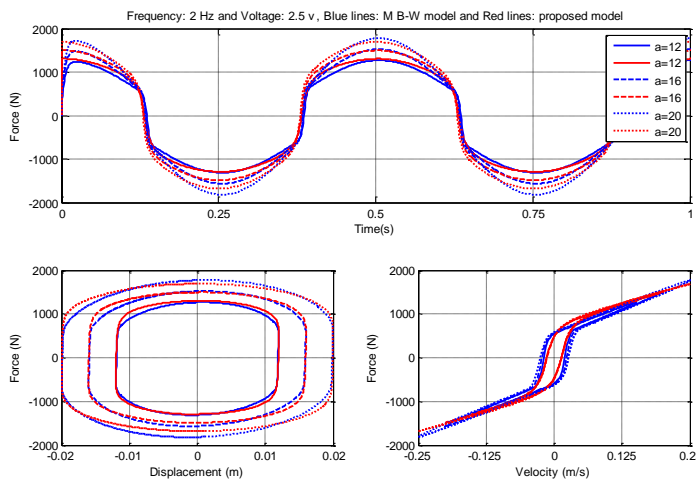

Figure 6. Comparison between the proposed model and modified Bouc-Wen model at $f = 2$ Hz, and $v = 2.5$ v and different amplitude

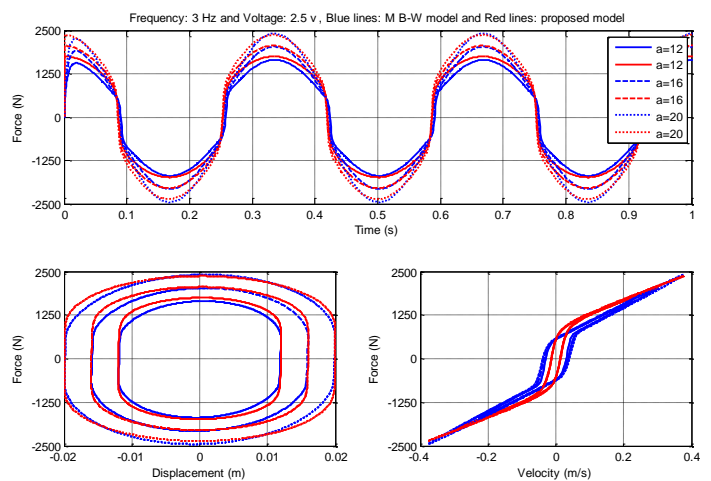

Figure 9. Comparison between the proposed model and modified Bouc-Wen model at $f = 3$ Hz, and $v = 2.5$ v and different amplitude

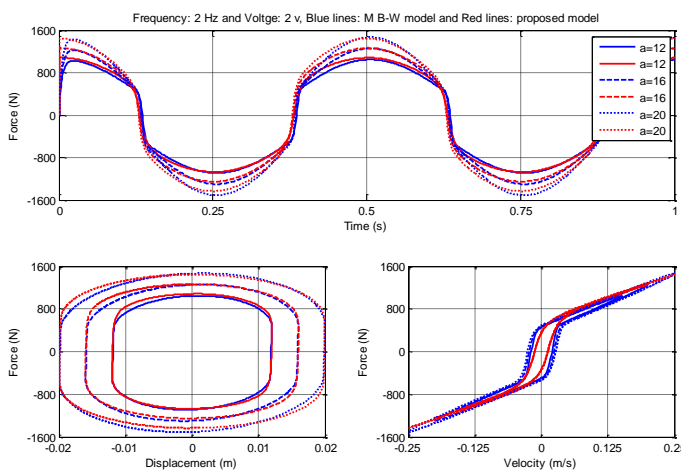

Figure 7. Comparison between the proposed model and modified Bouc-Wen model at $f = 2$ Hz, and $v = 2$ v and different amplitude

VI. Conclusion

This paper has proposed a development of an MR damper model to introduce a more simple and reliable model that can emulate the hysteretic behavior of the MR damper accurately. A PSO algorithm was used to identify the proposed model parameters using a simulated data based on the behavior of the modified Bouc-Wen model. The model permits an explicit demonstration of the MR damper force in terms of the instantaneous values of damper velocity, damper acceleration, and applied voltage to the damper coil. It does not include any complicated mathematical or differential equations, which will be very helpful for complicated engineering applications. The proposed model has therefore been shown to be a fast and reliable MR damper model, able to estimate the damping force for any desired set of amplitude, frequency, and command voltage. Simulation results, obtained using the proposed model, have shown extremely satisfactory concurrence with the modified Bouc-Wen model behavior and also confirmed the efficacy of the PSO identification algorithm.

Acknowledgment

This publication was supported by the European social fund within the frame work of realizing the project "Support of inter-sectoral mobility and quality enhancement of research teams at Czech Technical University in Prague", CZ.1.07/2.3.00/30.0034. Period of the project's realization 1.12.2013 – 30.6.2015.

References

- [1] Sadok, S., Khaled, C., Lotfi, M., Marc, T., & Asma, K., "An innovative magnetorheological damper for automotive suspension: from design to experimental characterization", *Smart Materials and Structural*, 14 (2005), pp. 811–822
- [2] Lam, A. H., Liao, H. W. "Semiactive control of automotive suspension systems with magnetorheological dampers", *International Journal of Vehicle Design*, 33 (2003), pp. 50–75.
- [3] Karkoub, M. A., Zribi, M., "Active / semiactive suspension control using magnetorheological actuators", *International Journal of Systems Science*, 37 (1) (2006), pp. 35–44.
- [4] Liao, W. H., Wang, D. H. "Semiactive vibration control of train suspension systems via magnetorheological dampers", *Intelligent Material Systems and Structures*, 14 (2003) 161–172.
- [5] Dyke, S. J., Spencer, B. F. Jr., Sain, M. K., Carlson, J. D., "Modelling and control of magnetorheological dampers for seismic response reduction", *Journal of Smart Materials and Structures*, 5 (1996), pp. 565–576.
- [6] Bani-Hani, K. A., Sheban, M. A., "Semiactive neuro-control for base-isolation system using magnetorheological (MR) dampers", *Earthquake Engineering and Structural Dynamics*, 35 (2006), pp. 1119–1144.
- [7] Spencer, B.F. Jr., Dyke, S.J., Sain, M.K., Carlson, J.D., "Phenomenological model for magnetorheological dampers, *Journal of Engineering Mechanics*", American Society of Civil Engineers 123 (3) (1997), pp. 230–238.
- [8] Wereley, N.M., Pang, L., Kamath, G., "Idealized hysteresis modeling of electrorheological and magnetorheological dampers", *Journal of Intelligent Material Systems and Structures* 9 (8) (1998), pp. 642–649.
- [9] Li, W. H., Yao, G. Z., Chen, G., Yeo, S. H., Yap, F. F., "Testing and steady state modeling of a linear MR damper under sinusoidal loading", *Journal of Smart Materials and Structures*, 9 (2000), pp. 95–102.
- [10] Lai, C.Y., Liao, W.H., "Vibration control of a suspension system via a magnetorheological fluid damper", *Journal of Vibration and Control*, 8 (4) (2002), pp. 527–547.
- [11] Dominguez, A., Sedaghati, R., Stiharu, I., "A new dynamic hysteresis model for magnetorheological dampers", *Journal of Smart Materials and Structures*, 15 (2006), pp. 1179–1189.
- [12] Metered, H., Bonello, P., Oyadiji, S., "Nonparametric identification modeling of magnetorheological damper using Chebyshev polynomials fits" , *SAE International Journal of Passenger Cars - Mechanical Systems*, 2 (1) (2009), pp 1125-1135.
- [13] Metered, H., Bonello, P., Oyadiji, S., "The experimental identification of magnetorheological dampers and evaluation of their controllers", *Mechanical systems and signal processing*, 24 (4) (2010), pp 976–994.
- [14] Chang, C.C., Roschke, P., "Neural network modeling of a magnetorheological damper", *Journal of Intelligent Material Systems and Structures* 9 (1998), pp. 755–764.
- [15] Chang, C.C., Zhou, L., "Neural network emulation of inverse dynamics for a magnetorheological damper", *Journal of Structural Engineering* 128 (2) (2002), pp. 231–239.
- [16] Xia, P. Q., "An inverse model of MR damper using optimal neural network and system identification", *Journal of Sound and Vibration*, 266 (2003), pp. 1009–1023.
- [17] Du, H., Lam, J., Zhang, N., "Modeling of a magnetorheological damper by evolving radial basis function networks", *Engineering Applications of Artificial Intelligence* 19 (2006), pp. 869–881.
- [18] Schurter, K.C., Roschke, P.N., "Fuzzy modeling of a magnetorheological damper using ANFIS", *Proceedings of the IEEE International Conference on Fuzzy Systems*, (2000), pp. 122–127.
- [19] Giuclea, M., Sireteanu, T., Stancioiu, T., & Stammers, C. W., "Model parameter identification for vehicle vibration control with magnetorheological dampers using computational intelligence methods", *Proceedings of the Institution of Mechanical Engineers, Part I: Journal of Systems and Control Engineering*, 218 (2004) (7), pp 569-581.
- [20] Kwok, M., Ha, P., Nguyen, H., Li, J., & Samali, B., "A novel hysteretic model for magnetorheological fluid dampers and parameter identification using particle swarm optimization", *Sensor Actuat A – Phys*, 2006, Volume: 132, pp 441–51.
- [21] Weng, J. S., Hu, H. Y., and Zhang, M. K., "Experimental modeling of magnetorheological damper", *Journal of Vibration Engineering* 13(4), 2000, pp. 616–620.
- [22] Guo, D. L., Hu, Y. H., "Nonlinear Stiffness of a Magneto-Rheological Damper *Journal of Nonlinear Dynamics*", 2005, Volume: 40, pp 241-249
- [23] Guo, D. L., Hu, Y. H., & Yi, J. Q. "Neural network control for a semi-active vehicle suspension with a magnetorheological damper", *Journal of Vibration and Control*, 2004, Volume: 10 (3), pp 461-471.
- [24] Lai, C. Y. & Liao, H. W. "Vibration Control of a Suspension System via a Magnetorheological Fluid Damper", 2002, *Journal of Vibration and Control*, Volume: 8 (4), pp 527-547.
- [25] J. Kennedy and R. Eberhart, "Particle Swarm Optimization," *Proceedings of IEEE International Conference on Neural Networks*, 1995, pp 1942–1948.
- [26] Shi, Y.; Eberhart, R.C., "A modified particle swarm optimizer," *Proceedings of IEEE International Conference on Evolutionary Computation*, 1998, pp 69–73.
- [27] M. Clerc, J. Kennedy, "The particle swarm: Explosion, stability, and convergence in a multidimensional complex space," *IEEE Transactions on Evolutionary Computation*, vol. 6, pp.58-73,2002.