

Design of FRP/steel Joints Bonded by Thick Adhesive Layers

Experimental characterization and numerical modelling using damage mechanics

Mohsen Heshmati, Reza Haghani, Mohammad Al-Emrani

Abstract— The use of fiber reinforced polymer (FRP) laminates to strengthen and repair of steel beams has increased during the last decade and is tending to replace traditional methods, such as welding or bolting of additional steel plates. In this context, one of the issues, which require more research, is design of adhesive joints used to bond FRP laminates to steel substrates. This paper is mainly concerned with evaluation of damage mechanics-based approaches to predict the strength of adhesive joints used to bond FRP laminates to steel beams. Adhesively bonded CFRP/steel double-lap shear specimens are numerically modeled using cohesive zone modeling (CZM) and the results are compared with experiments. The input cohesive material data are obtained from three series of experiments. The results indicate that the proposed methodology to obtain fracture data results in good predictions using CZM. The prediction method presented in this paper could be used in practice to determine the strength of the adhesive joints in FRP bonded steel beams.

Keywords—FRP, steel, joint, cohesive zone model, finite element analysis

I. Introduction

The strengthening and repair of structures using bonded carbon fiber reinforced polymer (CFRP) materials has attracted a great deal of attention. The method is well established and widely implemented when it comes to upgrading concrete structures. During the past decade, there has been a tendency to use this technique to upgrade structural steel members as well. The effectiveness of the method was demonstrated by the successful application of CFRP laminates for strengthening and repairing corroded and fatigue-damaged members, see, for example [1].

Despite research efforts, there are still some obstacles preventing the widespread use of this technique to upgrade steel structures. One of them is the lack of design methods to predict the strength of joints. The shortage of reliable design models, which is mainly due to the complexity of failure modes and the force transfer mechanism, is another obstacle to the development of design methods for such adhesive joints.

In the existing guidelines for the design of adhesive joints in CFRP-reinforced metallic beams, [2], an energy-based

method based on the energy release rate approach is considered. The energy release rate approach takes account of the energy released during the propagation of the crack along the adhesive joint. The design philosophy is that the fracture energy release rate (G), which can also be denoted as the crack extension force, during the propagation of the crack is obtained and compared with the critical energy release rate (G_c) and the criterion is that $G \leq G_c$.

Alternatively, damage mechanics approaches with both damage initiation and propagation criteria have been developed to overcome common singularity problems that are often observed in fracture mechanics approaches. In this regard, the Cohesive Zone Model (CZM), which was first introduced in [3,4] for metals, has been widely used to predict the progressive damage in adhesively bonded joints. When using CZM for progressive damage and failure modelling, the model simulates a microscopic damage along a pre-defined crack path. A traction-separation law between the originally coinciding nodes on both sides of the crack path is used for this purpose. In this concept, the stress singularity is omitted by adding a fracture process zone at the crack tip that describes the fracture process more realistically. However, when predicting the failure load and process of adhesively bonded joints, a unique set of CZM parameters should be determined properly. Various researchers have conducted different experiments to obtain these main parameters, which are the traction and fracture energy. Double Cantilever Beam (DCB) and End Notch Flexure (ENF) specimens were used in [5,6] to obtain mode-I and mode-II fracture energies, respectively. Da Silva [7] also proposed direct and inverse methods to determine CZM parameters and found that both approaches yield accurate responses for the studied material system. Nevertheless, as demonstrated in [8] many sets of CZM parameters can predict the failure load of a joint, while only a unique set provides the correct damage evolution.

A review of available design approaches reveals that there is lack of knowledge when it comes to the analysis and design of adhesively bonded CFRP/steel members in structural engineering. In addition, finding a unique set of CZM parameters, that not only predict the strength of the joint accurately but also model the correct damage evolution, is challenging. The purpose of this paper is to investigate critically the application of the damage mechanics approach in order to predict the load-bearing capacity of adhesive joints used to bond CFRP laminates to steel members by thick adhesive layers. The fracture mechanics properties of the adhesive material used in the study were defined by experimentally testing Double Cantilever Beam (DCB), and End Notch Flexure (ENF) specimens. Double Lap Shear (DLS) specimens made of steel plates and bonded CFRP

Mohsen Heshmati, Reza Haghani, Mohammad Al-Emrani
Chalmers University of Technology
Sweden

laminates on both sides subjected to tension were prepared and tested. Numerical models of all specimens using cohesive elements and a fracture energy-based material model for adhesive joints were developed in order to predict the failure load and investigate the damage initiation and growth within the adhesive layer in the specimens. This study focuses on a comparison of numerical and experimental results with regard to the load capacity and failure modes of the specimens.

II. Experimental study

A. Material properties

Three materials are used in this study, including prefabricated normal modulus carbon fibre reinforced polymer laminates, two-part epoxy adhesive Sto BPE Lim 567, and structural steel S355. In order to ensure an acceptable bond quality and subsequently cohesive failure in the adhesive layer, surface of steel substrate is sand blasted to standard level SA2½ prior to bonding, as suggested in [2]. Just before manufacturing specimens, steel plates are air blasted and cleaned with acetone to remove any residual dirt from the surfaces. All specimens are cured under ambient room temperature for a period of two weeks after adhesive bonding. The mechanical properties of materials used to manufacture specimens are presented in Table 1.

B. Peeling and shear behavior of the adhesive- DCB and ENF tests

Experiments with DCB specimen are performed to obtain the peel behaviour and fracture toughness of adhesive in mode I. The deformation of the adhesive layer at the crack tip, w , is measured as the relative displacement of the outsides of the two adherends, using two LVDT transducers. Additionally, a shaft encoder and a force transducer are used to measure the rotation at the loading point, θ_A , and applied load value, respectively. The points of load application are given a relative velocity of $10 \mu\text{m/s}$. The geometry of specimen is given in Fig. 1(a). More details about the testing setup is reported in [9].

The ENF specimen is the most widely used configuration for the assessment of mode II (shear) failure in adhesively-bonded joints. The ENF experiments for the adhesive used in this study was carried out by Salimi [10]. The tests were conducted using a tensile testing machine in which the applied force, P , displacement at the loading point, Δ , and shear deformation at the tip of the adhesive layer were measured.

TABLE I. MECHANICAL PROPERTIES OF THE MATERIALS USED TO MANUFACTURE SPECIMENS.

Material	E-modulus	Poisson's ratio
Adhesive (Sto BPE Lim 567)	7.0 ^a	0.3
CFRP	156	0.3
Steel (S355)	210	0.3

a. E-modulus was measured after 7 days

b. Data provided by manufacturer and tested at Laboratorium Budownictwa (www.lb.polub.pl)

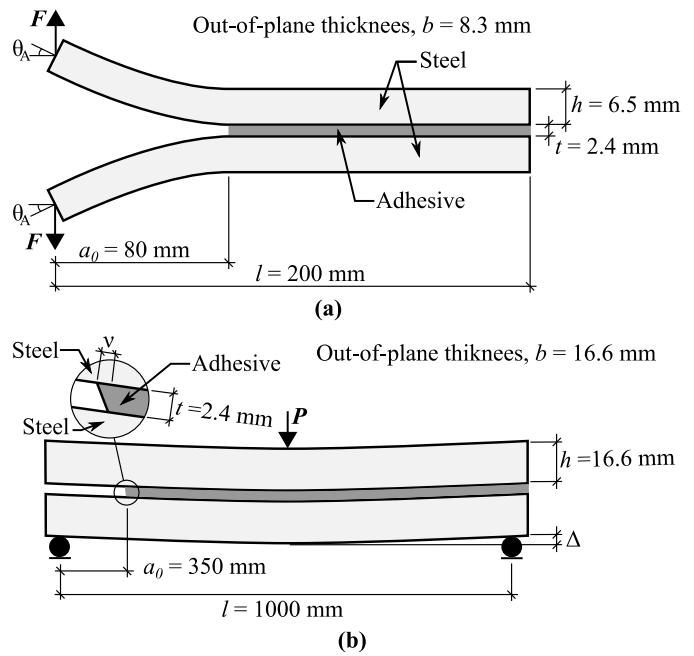

Figure 1. Geometry of specimens used in this study: (a) DCB, (b) ENF.

The geometry of specimen is shown in Fig. 1(b).

Fracture energy of adhesively-bonded specimens with thick adhesives, that are tested in pure mode I and pure mode II, can be obtained by the following equations ([10]):

$$J_{DCB} = \frac{2F}{b} \theta_A \quad (1)$$

$$J_{ENF} = \left[\frac{9}{16} \frac{P^2 a^2}{Eb^2 h^3} \left(1 + \frac{t}{h} \right) + \frac{3}{8} \frac{Pv}{bh} \right] \frac{\left(1 + \frac{t}{h} \right)}{1 + \frac{3}{2} \frac{t}{h} + \frac{3}{4} \left(\frac{t}{h} \right)^2} \quad (2)$$

where a is the initial crack length. Definition of other parameters can be found in Fig. 1(a) and (b). The cohesive relationships for the adhesive layer in mode I and mode II are plotted in Fig. 2. Such relationships are obtained by differentiating (1) and (2) and adapting a Prony series. It should be noted that, while the adhesive thickness is generally neglected in ENF tests, (2) is derived specially to account for adhesive thickness which may be considerable in joints with thick adhesive layers. The mean value for mode I critical fracture energy, G_{IC} , is found to be approximately 0.987 kJ/m^2 , with a maximum peel stress $\sigma_{\text{max}}=22.2 \text{ MPa}$ and critical deformation $w_c=70 \mu\text{m}$. In a similar manner, G_{IIIC} (and hence G_{IIIC}) is found to be 3.64 kJ/m^2 , with a maximum shear stress $\tau_{\text{max}}=27 \text{ MPa}$ and critical shear deformation $v_{\text{max}}=243 \mu\text{m}$. The stiffness is taken as the initial slope of cohesive law curve, in which $K_n=3.0$ and $K_s=1.0 \text{ MPa}/\mu\text{m}$ are found for mode I and mode II, respectively. These values are later implemented in the numerical study.

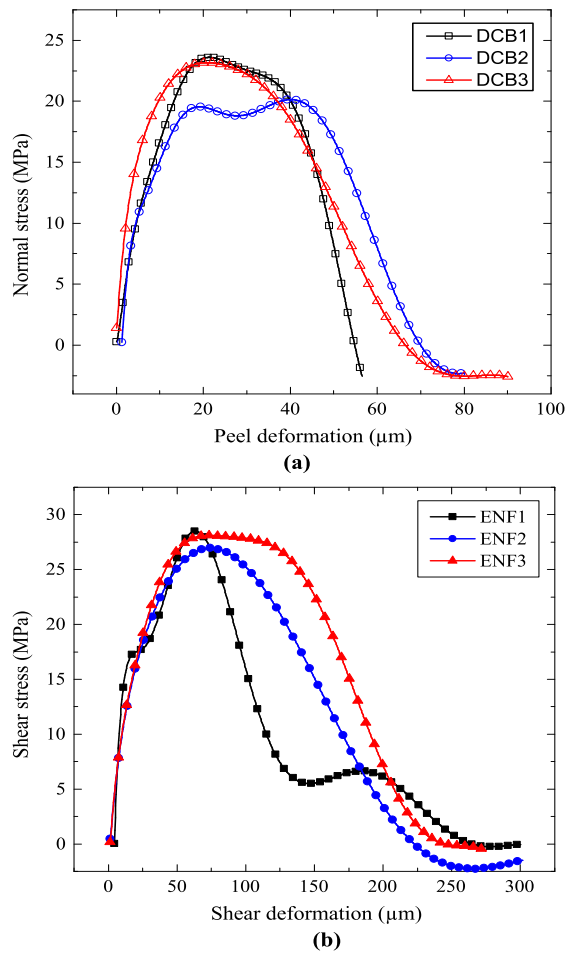

Figure 2. Cohesive laws for the adhesive loaded in (a) mode I, (b) mode II.

C. Double-lap shear specimens

The stress state at the adhesive ends in double-lap shear specimen is very similar to the case of steel girders strengthened with CFRP laminates, see [11]. In addition, relatively easy testing procedure and failure detection make DLS a valuable and reliable testing configuration. In this study, specimens consist of two 10mm thick \times 60mm wide steel plates bonded together using two 1.25mm \times 50mm wide CFRP laminates, see Fig. 3. The CFRP laminates are chosen

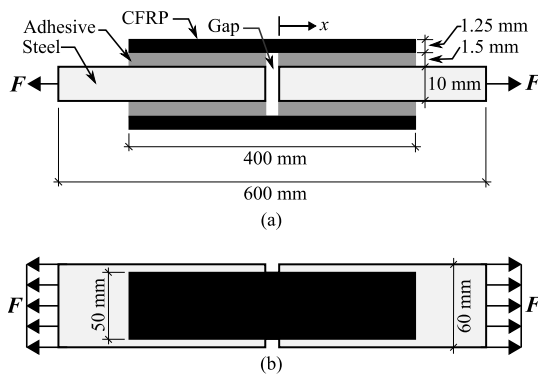

Figure 3. DLS joints: (a) side-view, (b) top-view

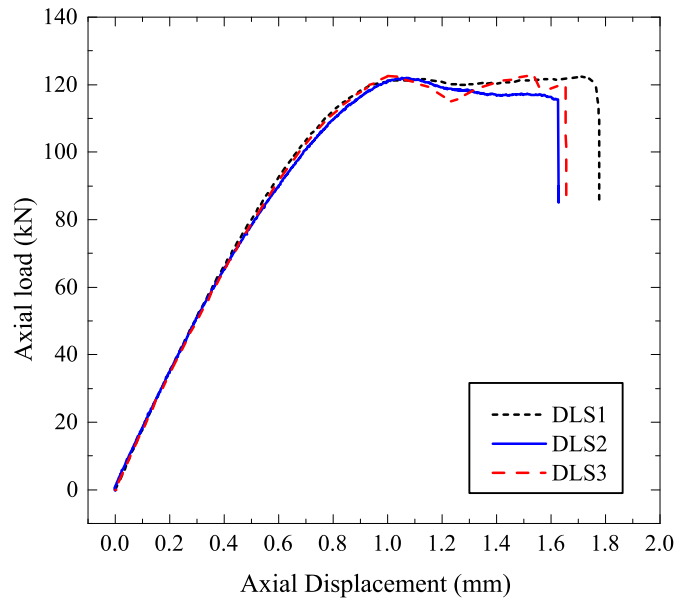

Figure 4. Double lap shear specimens test results

narrower than the steel plates to represent a typical field strengthening application in which the entire flange may not be covered by CFRP. In order to ensure the uniform thickness of the adhesive layer and suitable end detailing, i.e. without adhesive fillets at the ends, a special moulding form is designed. The specimens are tested using an MTS universal testing machine with a capacity of 250kN in displacement control mode at a rate of 1.0mm/min. The load-displacement and failure load of each specimen are recorded. The test results are plotted in Fig. 4. The failure locus in all specimens were in the adhesive layer (cohesive failure) and initiated from the center of the joint. The average ultimate strength is measured equal to 122.1 kN.

III. Numerical study

A. Theory

Cohesive elements implemented in the commercial finite element ABAQUS™ package can be represented as two cohesive surfaces separating from one another under shear or/and normal stresses. In this study, the bilinear traction separation law is defined by a linear elastic response, a strength criterion and a damage evolution law based on energies see Fig. 5(a). The damage initiation is determined using the quadratic nominal stress criterion. The damage propagation is studied in terms of energy release rate, and as the adhesive is most likely mixed-mode loaded, the dependence of its fracture energy on the mode mix is defined based on a power law fracture energy criterion, see Fig. 5(b). The power law exponent (α) was obtained through a parametric study under mixed-mode loading, where for $\alpha=0.8$, the analysis yielded most similar response to the experiments [10].

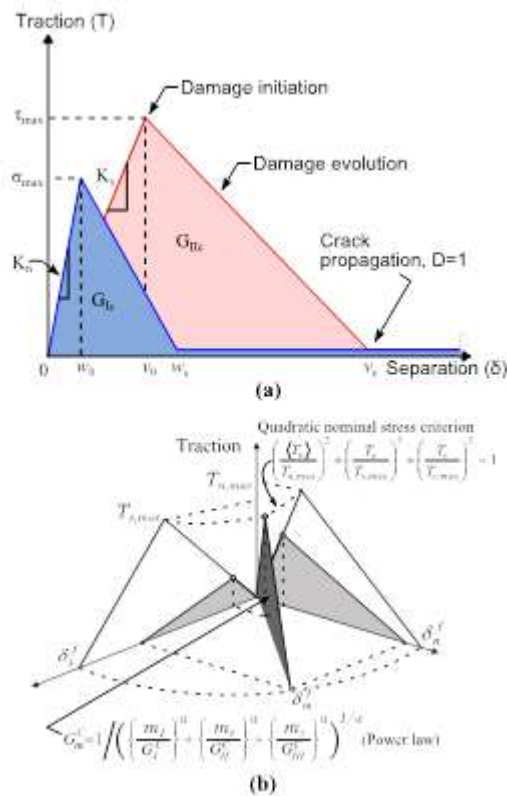

Figure 5. (a) Bilinear cohesive law, (b) CZM mixed mode in ABAQUS™.

B. Element type, mesh, boundary condition and applied load

All specimens are modelled using ABAQUS™. However, only the simulations of DLS specimens are discussed in this paper. Boundary conditions and general meshing are illustrated in Fig. 6(a). As the fracture mode in experiments was cohesive in adhesive layers, the cohesive elements are

placed in the middle of adhesive layers and the remaining adhesive is modelled using continuum elements. The whole configuration is modelled. Consequently, the existence of four adhesive layers implies that the joint may fail in a number of different scenarios, where the failure may initiate and propagate in a number of different combinations, see Fig. 6(b). In all models, 4-node quadrilateral plane stress elements (CPS4) are used to model CFRP, steel parts, and the adhesive. Cohesive elements are modelled by 4-node two-dimensional cohesive elements (COH2D4). The mesh size effect is investigated and it is found that cohesive elements with size of $0.02\text{mm} \times 0.1\text{mm}$ are sufficiently fine to yield accurate results. The steel plate on one end is fixed, while a prescribed displacement was applied to the other plate.

iv. Results and discussion

Fig. 7 shows the experimental and analytical results of DLS specimens. As can be seen, the simulation results generally correspond well to the experiments, both in terms of displacement and load. However, the FE model with diagonal cracks tends to yield more accurate results than the other failure modes. Numerical assessment of the results reveals a mean load bearing capacity of 122.1kN based on the experiments while a maximum load bearing capacity of 124.8 kN is obtained from the diagonal model, a difference in the order of 2%. In addition, mean deformation at failure of the DLS experiments is derived equal to 1.68mm compared to 1.67mm predicted by FE using the same model. In all cases, the FE simulations successfully predict the joint stiffness as well.

The FE results for diagonal model plotted in Fig. 7(a) shows that the simulation results are in excellent agreement for loads below 60 kN. It is anticipated that at this load, the damage status in the adhesive layer (along the CZM and continuum elements) is still zero throughout the bond length. By increasing the load, the FE predicted load-displacement curve starts to slightly deviate from the experiment, exhibiting

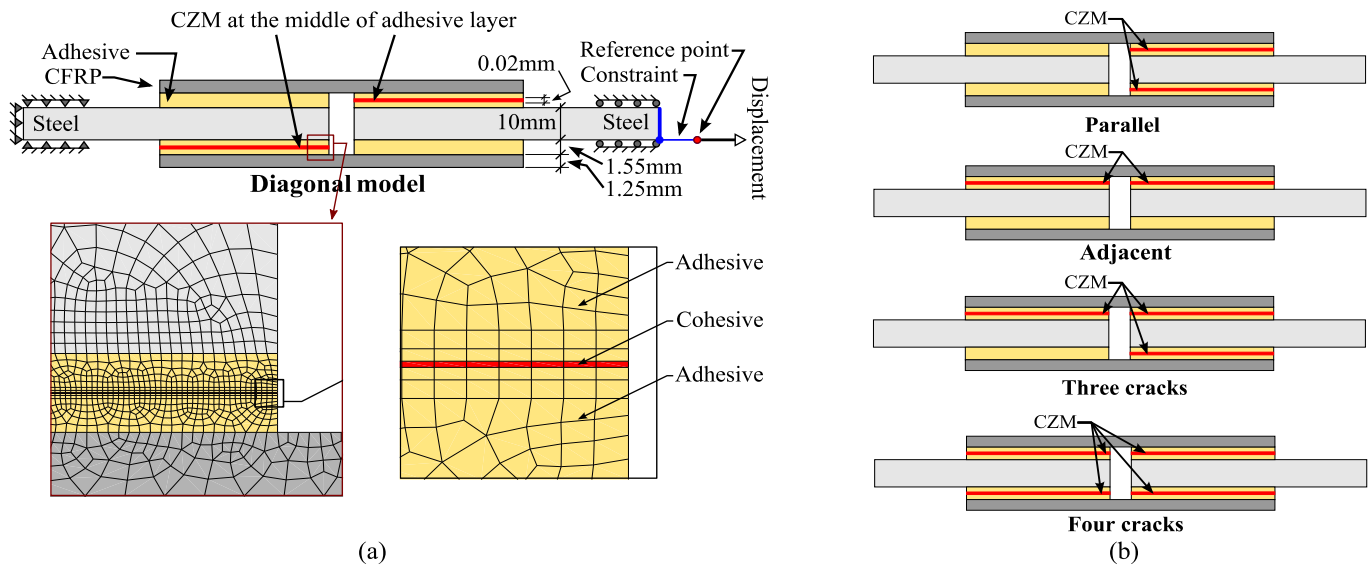

Figure 6. (a) The boundary conditions and general mesh of the DLS joints, (b) different investigated failure modes.

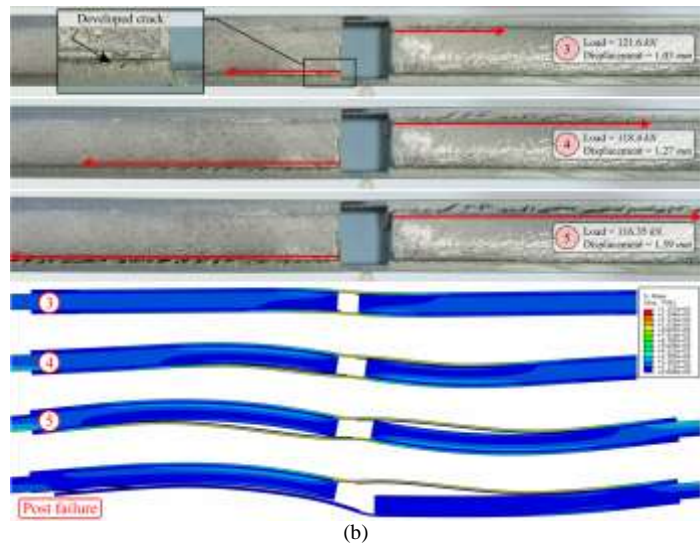
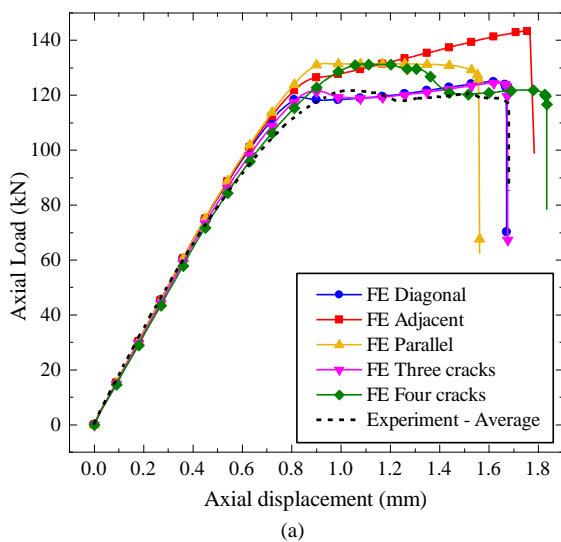

Figure 7. (a) Bilinear cohesive law, (b) CZM mixed mode in ABAQUS™.

a more stiff behaviour. This observation might be due to an underestimation of damage in the joint. An explanation would be that placing CZMs diagonally allows the damage occurrence in only two out of four adhesive layers in the joint.

In terms of failure pattern, monitoring the specimens during testing and after failure also showed similar failure mode to diagonal failure mode, see Fig. 7(b). This observation along with other analysis results confirm that the derived set of cohesive law parameters for the used adhesive are the unique set that is capable of providing the correct damage evolution.

v. Conclusions

A design procedure for CFRP/steel joints bonded by thick adhesive layers using damage mechanics is successfully established including experimental characterization and FE modelling procedures. Cohesive zone modelling is a technique based on damage mechanics which is mostly used to characterize the failure initiation and propagation in adhesive joints with thin adhesive layers, i.e. in the order of tenths of a mm. However, in the present study, the cohesive elements are used to model adhesive layers with an adhesive thickness of 1.5mm. Excellent agreement between the experimental and finite element results for DLS specimens indicated that this method can be used for such joints that are often found in civil engineering applications. Some key findings are summarised below:

- 1) The mode I and mode II fracture energy of thick adhesive specimens were characterized using DCB and ENF specimens, respectively.
- 2) The initial stiffness parameters (K_n and K_s) were extracted directly from DCB and ENF tests.
- 3) Distribution of crack-paths in joints with more than one adhesive bond does not affect the damage initiation. However, it has a considerable effect on post fracture response and ultimate strength of the joint. For design purposes, it is

recommended to account for all possible cracking scenarios and adopt the minimum ultimate strength.

- 4) The prediction of the load-bearing capacity of steel members strengthened with CFRP can be achieved using cohesive elements provided in the ABAQUS™ FE package.

References

- [1] Hollaway LC. A review of the present and future utilisation of FRP composites in the civil infrastructure with reference to their important in-service properties. *Constr Build Mater* 2010;24:2419–45.
- [2] Cadei JMC, Stratford TJ, Hollaway LC, Duckett WG. Strengthening metallic structures using externally bonded fibre-reinforced polymers 2004;44:174–80.
- [3] Barenblatt G. Equilibrium cracks formed during brittle fracture rectilinear cracks in plane plates. *J Appl Math Mech* 1959.
- [4] Barenblatt G. The mathematical theory of equilibrium cracks in brittle fracture. *Adv Appl Mech* 1962;7:55–129.
- [5] YANG Q. Numerical simulations of adhesively-bonded beams failing with extensive plastic deformation. *J Mech Phys Solids* 1999;47:1337–53.
- [6] Yang QD, Thouless MD, Ward SM. Elastic-plastic mode-II fracture of adhesive joints. *Int J Solids Struct* 2001;38:3251–62.
- [7] Da Silva LFM, Campilho RDSG. *Advances in Numerical Modeling of Adhesive Joints*. Berlin, Heidelberg: Springer Berlin Heidelberg; 2012.
- [8] Liljedahl CDM, Crocombe AD, Wahab MA, Ashcroft IA. Modelling the Environmental Degradation of the Interface in Adhesively Bonded Joints using a Cohesive Zone Approach. *J Adhes* 2006;82:1061–89.
- [9] André A, Haghani R, Biel A. Application of fracture mechanics to predict the failure load of adhesive joints used to bond CFRP laminates to steel members. *Constr Build Mater* 2012;27:331–40.
- [10] Salimi S. *Application of cohesive modeling in joining technology: Thick adhesive layers and rivet joints*. University of Skövde, 2012.
- [11] Haghani R, Al-Emrani M. A new design model for adhesive joints used to bond FRP laminates to steel beams. *Constr Build Mater* 2012;30:686–94.